

**Radio
Electronics®**

JANUARY 1993

Combined with
Electronics
NOW®

Build this
WORLD BAND RECEIVER
and tune in the world!

Build our
DIGITAL VOICE CHANGER
and have fun with
Digital Signal Processing!

Build the
**REMOTE PC
POWER CONTROL**
and boot your PC from a
remote location!

A look at
SSAVI DESCRAMBLING
circuit techniques

All about
CRYSTAL OSCILLATORS
and how to use them

You can
TALK ON A LIGHT BEAM
with our Air Hop transceiver



- Plus: ★ Video News
★ Hardware Hacker
★ Audio Update
★ And Lots More!



\$3.50 U.S.
\$3.95 CAN

A
GERNSBACK
PUBLICATION

Top Choices.

Fluke meters are your top choice for accuracy, reliability, and performance. They offer

more combinations of features and functions than any other meters on the

Fluke 97
ScopeMeter®

market. Features like true-rms measurements, high resolution,

Smoothing™ and Peak Hold. Or simultaneous scope and meter

functions in one portable package. Whichever Fluke meter

you choose you can count

on benchtop accuracy,

test lab versatility, and

handheld convenience.

Plus, Fluke keeps you

covered with a full line of quality

accessories, strong customer support,

and product warranties that measure up

to any in the industry. When it's up to you to get the job done, look to

Fluke for the choices you need to get it done right. See your

Fluke distributor, or call **1-800-87-FLUKE**

8060A

for a catalog and the name of the

distributor nearest you.



Fluke 87

Fluke 79

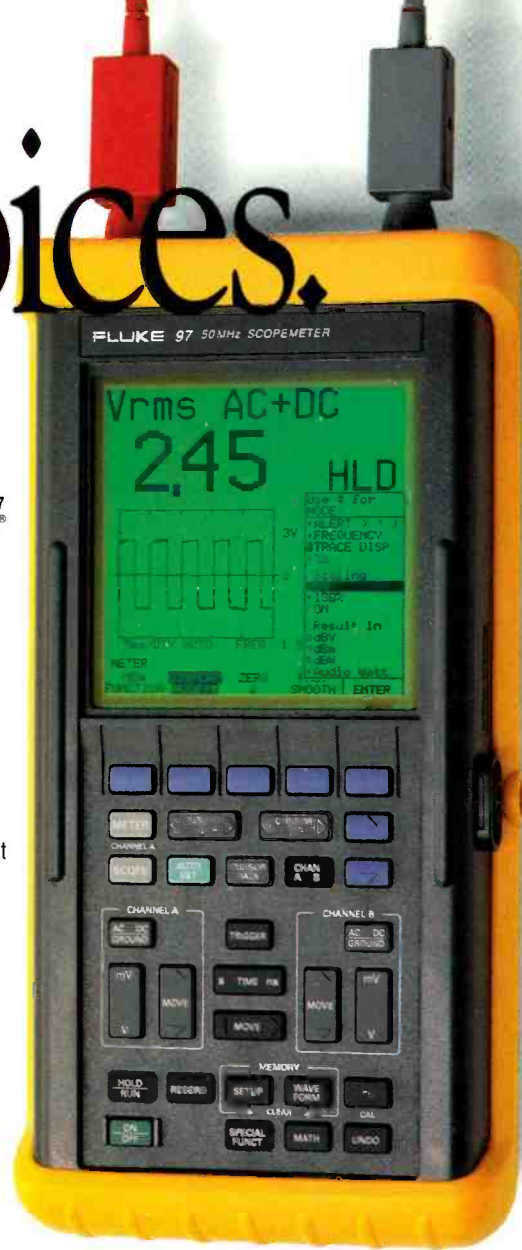

FLUKE 79 FLUKE 87 8060A FLUKE 97

The Fluke meters listed above feature diode test, auto and manual range, continuity, and frequency measurements

Lo-Ohms measurements	True-rms	True-rms	True-rms ac, or ac & ac
Capacitance measurements	Capacitance measurements	Resistance measurements to 300 MΩ	Scope, Meter or simultaneous meter and scope display
Smoothing™	Duty Cycle measurements	High-impedance DC voltage function	Dual Trace 50 MHz bandwidth
4000 count display	20,000 count high resolution display	20,000 count display	40 nanosecond glitch capture
Basic accuracy 0.5%	Offset/Relative reference 1 millisecond Peak Hold	Offset/Relative reference dB measurements	Stores waveforms and setups dBm, dBV, dB Relative and Audio Watt calculations
	Basic accuracy 0.1%	Basic accuracy 0.04%	Basic accuracy 0.5%

John Fluke Mfg. Co., Inc.
P. O. Box 9090, Everett, WA 98206
For more information call:
(416) 890-7600 from Canada
(206) 356-5500 from other countries

© Copyright 1992 John Fluke Mfg. Co. Inc. All rights reserved.
Ad No. 00282

FLUKE®
CIRCLE 121 ON FREE INFORMATION CARD

ON THE COVER



In the last few years, the world has witnessed major upheavals and unprecedented changes—such as the Gulf war, the war in Yugoslavia, the end of the Cold War, and the fall of the Berlin Wall. You can read newspaper accounts, or listen to radio and television news. But, for a truly unique perspective on international news, nothing beats shortwave

radio. Unfortunately, many commercial world band receivers, particularly the less expensive models, suffer from poor reception. But not you can build your own world band receiver that uses traditional circuit design to deliver performance that rivals the costliest store-bought rigs—for less than \$100. Turn to page 31 for all the details.

DIGITAL VOICE CHANGER

You can create unusual sound effects using some high technology with our voice changer.

DAVID WILLIAMS

While using a digital voice changer, you can create unusual sound effects using some high technology with our voice changer. The device is designed to be used with a standard microphone and a speaker. It takes an input signal and processes it to create a variety of sound effects, including pitch bending, time stretching, and more. The device is easy to use and can be controlled via a remote control. The author, David Williams, provides a detailed circuit diagram and construction instructions for the device. The device is built using a microcontroller and several integrated circuits. It is a fun project for anyone interested in electronics and sound effects.

REMOTE CONTROL POWER SWITCH

Turn appliances on and off using any remote control with these IR switches.

JAMES LABSO

The device lets you control your appliances with a remote control. It is a simple and effective way to control your appliances. The device is built using a microcontroller and several integrated circuits. It is a fun project for anyone interested in electronics and remote controls. The author, James Labso, provides a detailed circuit diagram and construction instructions for the device. The device is built using a microcontroller and several integrated circuits. It is a fun project for anyone interested in electronics and remote controls.

1992 ANNUAL INDEX

Electronics NOW Volume 63

1992 Annual Index Electronics Now, Volume 63
 Circulation: 1,000,000 U.S. (All Media) Labels: 100,000,000
 Circulation: 1,000,000 U.S. (All Media) Labels: 100,000,000
 Circulation: 1,000,000 U.S. (All Media) Labels: 100,000,000

PAGE 39

PAGE 43

PAGE 65

As a service to readers, ELECTRONICS NOW publishes available plans or information relating to newsworthy products, techniques and scientific and technological developments. Because of possible variances in the quality and condition of materials and workmanship used by readers, ELECTRONICS NOW disclaims any responsibility for the safe and proper functioning of reader-built projects based upon or from plans or information published in this magazine.

Since some of the equipment and circuitry described in ELECTRONICS NOW may relate to or be covered by U.S. patents, ELECTRONICS NOW disclaims any liability for the infringement of such patents by the making, using, or selling of any such equipment or circuitry, and suggests that anyone interested in such projects consult a patent attorney.

ELECTRONICS NOW, (ISSN 0033-7862) January 1993. Published monthly by Gernsback Publications, Inc., 500-B Bi-County Boulevard, Farmingdale, NY 11735. Second-Class Postage paid at Farmingdale, NY and additional mailing offices. Second-Class mail registration No. R125166280, authorized at Toronto, Canada. One-year subscription rate U.S.A. and possessions \$19.97, Canada \$27.79 (includes G.S.T. Canadian Goods and Services Tax Registration No. R125166280), all other countries \$28.97. All subscription orders payable in U.S.A. funds only, via international postal money order or check drawn on a U.S.A. bank. Single copies \$3.50. © 1992 by Gernsback Publications, Inc. All rights reserved. Printed in U.S.A.

POSTMASTER: Please send address changes to ELECTRONICS NOW, Subscription Dept., Box 55115, Boulder, CO 80321-5115.

A stamped self-addressed envelope must accompany all submitted manuscripts and/or artwork or photographs if their return is desired should they be rejected. We disclaim any responsibility for the loss or damage of manuscripts and/or artwork or photographs while in our possession or otherwise.

PLEASE TURN PAGE FOR COMPLETE CONTENTS

BUILD THIS

31 WORLD BAND RADIO RECEIVER

Enjoy better-than-store-bought shortwave reception from a home-brewed set!

John Pivnichny, N2DCH

39 DIGITAL VOICE CHANGER

You can sound like a robot—or a chipmunk with our sound-effects device.

David Williams

43 REMOTE CONTROL POWER SWITCH

Use any remote control to turn appliances on and off.

Jaime Lasso

51 LIGHT BEAM COMMUNICATOR

Part II of the "Air Hop" project—put it to work!

Rodney A. Kreuter

COMPUTERS

55 BOOT YOUR PC REMOTELY

For less than \$80, you can build the Ring-Thing!

Thomas E. Black

TECHNOLOGY

45 CRYSTAL OSCILLATORS

Learn all about crystal resonators and how they work.

Dan Becker

DEPARTMENTS

6 VIDEO NEWS

What's new in this fast-changing field.

David Lachenbruch

16 EQUIPMENT REPORT

IC Master on CD-ROM

69 HARDWARE HACKER

High-side FET drivers, and more.

Don Lancaster

80 AUDIO UPDATE

Poor man's FM antenna.

Larry Klein

83 DRAWING BOARD

Video descrambling

Robert Grossblatt

87 COMPUTER CONNECTIONS

Desktop video.

Jeff Holtzman

AND MORE

98 Advertising Sales Offices

98 Advertising Index

65 Annual Index

91 Buyer's Market

12 Letters

26 New Lit

18 New Products

8 Q&A

4 What's News

Electronics NOW[®]

Hugo Gernsback (1884-1967) founder

Larry Steckler, EHF, CET,
editor-in-chief and publisher

EDITORIAL DEPARTMENT

Brian C. Fenton, editor

Marc Spiwak, associate editor

Nell Sclater, associate editor

Teri Scaduto, assistant editor

Jeffrey K. Holtzman
computer editor

Robert Grossblatt, circuits editor

Larry Klein, audio editor

David Lachenbruch
contributing editor

Don Lancaster
contributing editor

Kathy Terenzi, editorial assistant

ART DEPARTMENT

Andre Duzant, art director

Injae Lee, illustrator

Russell C. Truelson, illustrator

PRODUCTION DEPARTMENT

Ruby M. Yee, production director

Karen S. Brown
advertising production

Marcella Amoroso
production assistant

Lisa Rachowitz
editorial production

CIRCULATION DEPARTMENT

Jacqueline P. Cheeseboro
circulation director

Wendy Alanko
circulation analyst

Theresa Lombardo
circulation assistant

Michele Torriilo
reprint bookstore

Typography by Mates Graphics
Cover photo by Diversified Photo
Services.

Electronics Now is indexed in
Applied Science & Technology Index,
and Readers Guide to Periodical Literature,
Academic Abstracts, and
Magazine Article Summaries.
Microfilm & Microfiche editions are
available. Contact circulation depart-
ment for details.

**Advertising Sales Offices listed
on page 102.**

Electronics Now Executive and
Administrative Offices
1-516-293-3000.

Subscriber Customer Service:
1-800-288-0652.

Order Entry for New Subscribers:
1-800-999-7139.



Audit Bureau
of Circulations
Member



THE SURVIVAL KIT



THE RIGHT PRODUCTS FOR THE LONG RUN

A new family of chemicals and supplies from CHEMTRONICS® containing either no ozone depleting substances or greatly reduced levels.

Circuit board flush/degreasing: CFC Free Electro-Wash® 2000

Dust and dry dirt removal: Ultrajet® 2000, contains no ozone-depleting substances

Chemtronics SURVIVAL KIT product labels include full environmental impact data, including all contents and ozone depletion potential (ODP).

Locate heat-induced component failures: Freeze-It® 2000, contains no ozone-depleting substances

Switches, pots and relay cleaning: Contact Clean 2000

Flux removal: CFC Free Flux-Off® 2000



Chemtronics®

Desoldering: Chem-Wik® Lite meets MIL-F-14256E

CIRCLE 54 ON FREE INFORMATION CARD

www.americanradiohistory.com

For more information, call our toll-free Customer Service number, 1-800-645-5244, or our Technical Support number, 1-800-333-4011.

WHAT'S NEWS

A review of the latest happenings in electronics.

Personal communications services spectrum allocated

In September the FCC allocated 22 MHz of bandwidth in three chunks for use by "emerging technologies," clearing the way for personal communications services (PCS)—the so-called "poor man's cellular phone"—to come into its own. Voice and data services based on a PCS microcell network, as well as other "future mobile services," are to have use of the frequencies between 1.85 and 1.99 GHz, 2.11 and 2.15 GHz, and 2.16 and 2.2 GHz.

Now that the bandwidth is available, the next challenge for PCS suppliers is to clarify their positions in relation to the cellular phones and paging services already in use. To accomplish that objective, Stamford, CT-based GTE Corp. is carrying out a PCS experiment.

Also in question are the rights of "incumbent users" of the three designated bands. According to the latest FCC figures, approximately 24,000 licensees already maintain about 29,000 microwave links, with channels ranging in width from 800 kHz to 10 MHz. Those licensees, who are now using the bands for public and private microwave communications, are up in arms.

As a compromise, the FCC has set up a minimum transition period of three years, during which current users and PCS providers are to negotiate relocation terms on their own. At the end of the transition period, current users would retain equal claims to the spectrum, with the exception of cases in which there is radio interference between operations. If a PCS provider needs the frequencies, he is expected to work out a voluntary relocation settlement with the incumbent user. If they are unable to reach a relocation agreement, the PCS provider can ask the FCC for an involuntary relocation (state and local govern-

ment agencies are exempt)—at a cost. The PCS provider must pay all relocation expenses, build the new facilities, and test them to ensure that they are compatible with the old frequencies. According to FCC commissioner Sherrie Marshall, "Making new users pay to move existing users provides an incentive to share."

Electronic traffic management

Dover Electronics (Binghamton, NY) and AT/Comm (Marblehead, MA) are working together to develop radio-frequency identification systems for use in the transportation industry.

The first product, expected to be available in the fourth quarter of 1992, is a system for non-stop electronic toll collection. The patented technology allows motorists to drive through toll gates without stopping, easing traffic jams and reducing fuel consumption and auto emissions. The system, which has been tested at speeds in excess of 90 mph, is based on two-way radio-communications techniques known as "read-write."

The system is to compete with "read-only" toll-collection processes, in which vehicles have either bar-code tags or radio reflective tags that are read as the vehicle passes a toll. That process is troublesome to advocates of personal privacy because it requires toll agencies to maintain accounts and travel records for all of their once-anonymous patrons.

Read-write refers to a non-stop toll-collection process that provides intelligence in the transponder. Not only can the device be read as it passes through a toll gate, but information can also be written onto the transponder. For example, the entry point of a turnpike could be entered so that the proper toll could be calculated upon exit.

In the AT/Comm microprocessor-based read-write system, pre-paid toll accounts are maintained in the transponder, eliminating the costs involved in centralized accounting. Like a postage meter, the transponder is electronically charged with a value, and that value is reduced each time the car passes through a toll lane.

An LCD readout and an audible alarm on the device give the motorist real-time information on his or her account. That way the motorist knows when to "refill" his account.

The "smart transponder" is also a platform for other Intelligent Vehicle Highway System (IVHS) applications, such as incident warnings, automated parking, commercial vehicle access control at airports, and other traffic management uses.

HDTV cooperative agreement

Four major participants in the development of high-definition television (HDTV) have signed an agreement to share the risks and rewards for their respective approaches. AT&T, General Instruments Corp., the Massachusetts Institute of Technology, and Zenith Electronics Corp. agreed to share in future royalty income if any of their entries are selected by the Federal Communications Commission as the HDTV standard.

All of the participants are developing digital systems that are being evaluated on technical merit by the FCC. Under the agreement, the parties have promised to work with each other to enhance the system selected by the FCC. To maintain competitiveness, none of the team's concepts will be merged or enhanced prior to the FCC decision. The GI/MIT and Zenith/AT&T teams will continue to promote their respective systems until that decision is made.

A-E

More Lessons!

More Services!

A Shocking Offer!

Now you don't have to be enrolled at CIE to receive our introductory Electronic and Electricity Lesson Modules. This program is available for a limited time to non-students for the shockingly low price of only \$99.50.

With CIE's patented AUTO-PROGRAMMED method of learning you will quickly learn and then master the basics of electronics and electricity and then move on to... DC/AC circuit theories, fundamentals of bi-polar junction transistors (BJT), field effect transistors (FET), wiring, diagram and schematic readings, component identification, soldering techniques... and much, much, more. This introductory offer includes the first 39 lessons in CIE's Associate in Applied Science in Electronic Engineering Technology Degree.

Your commitment to CIE ends with your payment, but CIE's commitment to your success just begins when you receive your lessons, exams, binder and equipment. This special introduc-

tory price includes all the benefits and assistance CIE normally extends to its full time students. You'll be entitled to unlimited access to CIE's faculty and staff to assist you in your studies via a toll free 800 number six days a week, 24-hour turnaround on grading your submitted exams, CIE bookstore privileges, a patented learning method, reference library, access to CIE's electronic bulletin board and a free issue of CIE's school newspaper The Electron.

And best of all, when you decide to continue your electronics education in any of CIE's programs you'll receive full academic credit for successful lessons submitted and a \$100.00 Tuition Credit Certificate.

All this knowledge and support will put you on the road to understanding digital electronics, automotive and industrial electronics, microprocessing principals, computer systems, telecommunications and much, much, more.

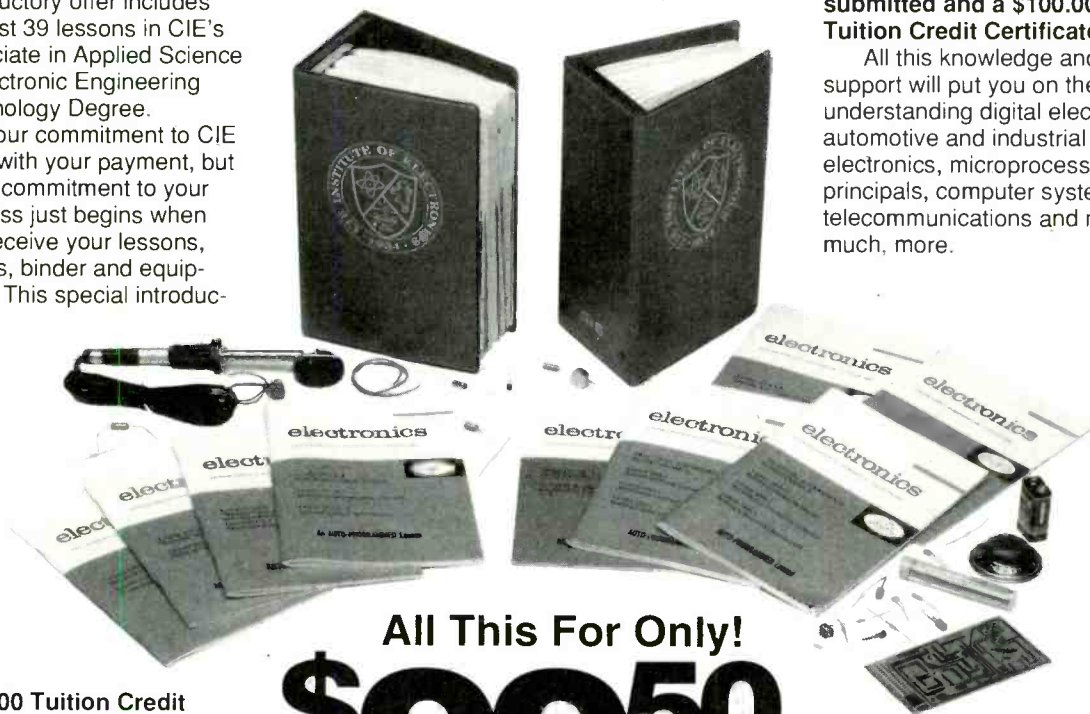

All This For Only!

\$99⁵⁰

- \$100.00 Tuition Credit
- Academic Credit
- Free issue of The Electron
- Build your personal burglar alarm
- Toll Free Instructor Assistance
- 24-hour grading
- CIE bookstore privileges

- 39 theory and hands-on training lessons and exams.
- Patented learning method
- CIE electronic bulletin board privileges

Yes! Send me CIE's Introductory Electronic and Electricity Lessons and Equipment.

A7317

Name: _____

Street: _____ Apt#: _____

City: _____

State: _____ Zip: _____

Age: _____ Phone: (_____) _____



BOOKSTORE
1776 East 17th Street
Cleveland, Ohio 44114

Total Merchandise: _____ \$99.50

Ohio Residents add 7% Sales Tax: _____

California Residents add 6 1/2% Sales Tax: _____

Total This Order: _____

Shipping and Handling Charge: _____ \$5.00

Method of Payment/Amount Enclosed: _____ \$

Personal Check or Money Order

Master Card Visa Discover

Card Expiration Date: _____

Signature: _____



CHARGE BY PHONE!

9 AM to 4:30 PM Eastern Time:
1-800-321-2155 ext. A7317

January 1993, Electronics Now

VIDEO NEWS

What's new in the fast-changing video industry.

DAVID LACHENBRUCH

• **More video CD's.** New video CD-ROM's keep turning up at a dizzying pace—certainly dizzying to consumers who now can be expected to stay away until the dust settles. First there was Commodore's CDTV, originally fielded as a consumer-oriented TV attachment. That was followed by Philips' CD-I, a strictly consumer system. Next came VIS, the Video Interactive System backed by Tandy Corporation (Radio Shack) and Zenith Electronics (**Electronics Now**, December 1992). This month, I am able to report on three more CD systems that include a consumer, an industrial, and consumer/industrial hybrids. The systems all have one thing in common: They're mutually incompatible!

• **Sony's multimedia player.** Sony has finally come out with its widely heralded CD-ROM player, which formerly went under the working title of "Bookman." Sony identifies its software as MMCD, for "Multimedia CD-ROM." Like most of the other systems, it uses five-inch compact discs as its storage medium. MMCD supports the CD-ROM XA (extended architecture) format, so its discs can also be played on personal computers that have been adapted with XA drives.

But MMCD is primarily designed to play through TV monitors or to be used as a stand-alone portable system. The first Sony player has a 4.5-inch monochrome LCD screen and is easily hand-held, so it may be used to access data on the go, or for consulting CD-ROM service manuals while repairing equipment, for example. When plugged into a color monitor or TV, it displays a color picture. Each five-inch disc can hold more than 600 megabytes of data. Fifty discs were available at launch, priced from \$35 to \$150. One of the most impressive features of the XA architecture is its

ability to interleave audio and video data on disc resulting in accurate synchronization.

Like most other systems, MMCD doesn't yet achieve full motion video, but it can show partial-screen movement at 15 frames per second. One of the major advantages of the Sony system is its ease of adapting existing CD-ROM programs to its format. That's the same advantage claimed for the VIS system, but the two systems can't be considered compatible. The disadvantage of MMCD so far is its high cost—\$1000, including two discs for the portable player.

• **DVI full-motion video.** Digital Video Interactive, usually known as DVI, the favorite of many people in the industry, could show up soon as a consumer system. This system is being pushed by Intel, although it was developed by RCA's Sarnoff Labs in the 1980's. Denon America, the U.S. subsidiary of Nippon Columbia, which is the official licensor of the system for Japan, is showing the first consumer applications of DVI.

One of DVI's big advantages is its ability to show full-motion video now—not later. But Denon says it won't release a DVI consumer product until it can show video equal to laserdisc quality—a challenge that none of its competitors have accepted, much less met. Insiders report that under some conditions Denon has been able to bring DVI to laserdisc quality. Denon currently is working on a variable-rate compression system: A high rate of compression is used during scenes with rapid motion, and a lower rate for more static scenes.

• **Analog/digital LD-ROM.** Laserdisc quality is generally accepted as the standard goal for video—so why not a laserdisc ROM? That's the reasoning of laserdisc ex-

ponent Pioneer. That company, which owns many laserdisc patents and is the leading supplier of discs and players on the world market, has introduced its "LD-ROM" system to the industrial and commercial markets, to which it provides custom-made software. That system uses what looks like a conventional 12-inch laserdisc with up to an hour of full-motion analog video, combined with 540 megabytes of digital signal memory. The result is excellent interactivity combined with sharp full-motion video pictures on a highly interactive disc. Currently, says Pioneer, there are no plans to introduce LD-ROM to the consumer market. But Pioneer also says it's working on compression technology that will "dramatically increase the amount of information" that can be stored on a CD or laserdisc. Another system in the works, maybe?

• **New camcorder configuration.** Just as there are many variations in film cameras, Sharp believes that there's room for different kinds of video camcorders. So Sharp pioneered the Twincam, the only dual-lens camcorder currently available. Now the same company is introducing an even bolder innovation—Viewcam. The first model, introduced in Japan and due here in February, employs the Hi8 format, but others are expected in standard 8mm size. In place of a tiny viewfinder, Viewcam has a 4-inch color LCD mounted beside the camera portion of the camcorder that is able to swivel 180° vertically. The user can hold the instrument at waist level and look down into the viewer, or shoot over the heads of the crowd by looking up into the viewer. The viewing screen can be twisted so that the operator can get into the picture while viewing the LCD; the supplied remote control cable operates the camera. **R-E**

Take Any **3** PROFESSIONAL BOOKS only for \$9⁹⁵

when you join the **ELECTRONICS ENGINEERS' BOOK CLUB**

Values to \$162.40



9255-XXX \$105.00
Counts as 3



003961 \$39.95



003957-XX \$49.95
Counts as 2

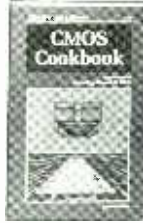

9244P \$18.95
Softcover



585261-XX \$52.00
Counts as 2



071231 \$57.95

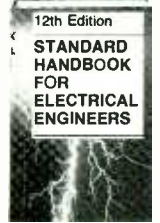

020975-XXX \$104.50
Counts as 3



3147-XX \$38.95
Counts as 2

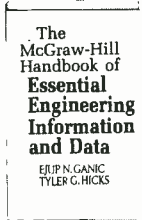

022764-XX \$92.50
Counts as 2



050806 \$54.95

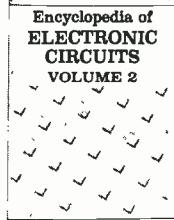

3138-XX \$60.00
Counts as 2



3279 \$36.95

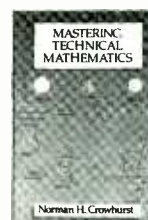

3438 \$39.95

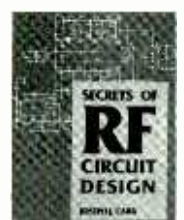

3710 \$32.95



3321P \$16.95
Softcover



3837 \$27.95



3151 \$42.95



2962P \$17.95
Softcover



3212-XX \$39.95
Counts as 2



025354 \$29.95



10010P \$22.95
Softcover

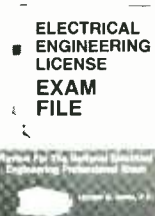

585247-XX \$31.95
Counts as 2



3365P \$24.95
Softcover



3991 \$39.95



3102-XX \$49.95
Counts as 2



2672 \$49.50

As a member of the **Electronics Engineers' Book Club** . . .

. . . you'll enjoy receiving Club bulletins every 3-4 weeks containing exciting offers on the latest books in the field at savings of up to 50% off of regular publishers' prices. If you want the Main Selection do nothing and it will be shipped automatically. If you want another book, or no book at all, simply return the reply form to us by the date specified. You'll have at least 10 days to decide. And you'll be eligible for **FREE** books through our **NEW** Bonus Book Program. Your only obligation is to purchase 3 more books during the next 2 years, after which you may cancel your membership at any time.

All books are hardcover unless otherwise noted. Publishers' prices shown. ©1993 EEBC
A shipping/handling charge and sales tax will be added to all orders.

If coupon is missing, write to:
Electronics Engineers' Book Club, Blue Ridge Summit, PA 17294-0860

ELECTRONICS ENGINEERS' BOOK CLUB

Blue Ridge Summit, PA 17294-0860

YES! Please send me the book(s) listed below for just \$9.95, plus shipping/handling & tax. Enroll me as a member of the **Electronics Engineers' Book Club** according to the terms outlined in this ad. If not satisfied, I may return the book(s) within ten days and have my membership cancelled. A shipping/handling charge & tax will be added to all orders.

--	--	--

If you select a book that counts as 2 choices, write the book number in one box and XX in the next.
If you select a Counts as 3 choice, write the book number in one box and XXX in the next 2 boxes.

Name _____

Address _____

City/State _____

Zip _____ Phone _____

Valid for new members only, subject to acceptance by EEBC. Canada must remit in U.S. funds. Applicants outside the U.S. and Canada will receive special ordering instructions. RPIF193

Write to Q & A, *Electronics Now*, 500-B Bi-County Blvd., Farmingdale, NY 11735

REEL-TO-REEL DEAL

I recently bought a used Sony reel-to-reel tape recorder at a pawn shop and it's working perfectly. The sound quality is excellent, and it's very easy to do editing on it—which is the reason I bought it in the first place. Just about the only problem I'm having is finding tape for it. The tape I have is Sony SLH-180-36, a professional high-grade tape. Do you know of any place where I can buy reel-to-reel tape? The machine takes up to 10½-inch reels, which are the ones I would really prefer to buy.—J. Clark, Thomasville, GA

It's sad to say, but it seems to me that it's getting much closer to the day when reel-to-reel tape recorders will go the way of records. With the exception of some professional uses, such as sound recording in the movie business and a few others, numbers like 7½ and 15 inches per second will have meaning only for people who measure the speed of fast-moving glaciers.

That day, however, isn't here yet, and while it's not as easy as it once was to get reel-to-reel recording stock, it's certainly not impossible. A quick glance at a 1993 Radio Shack catalog shows that the company still sells tape in various lengths on 7-inch reels. There are also several other companies that still carry reel-to-reel stock in their current product line. These companies include, in no particular order, Scotch (3M) in St. Paul, Minnesota, Sony, and Ampex.

Take good care of the tape you buy because you're going to find the prices to be fairly high. That's due to the cost of the raw material and the fact that the market for the product is shrinking. The biggest market for reel-to-reel products is professional, and prices are a lot higher in the professional market than they are in the consumer market.

386 STACK OVERFLOW

I recently bought a 386 clone because I have to run an engineering analysis program that requires a 32-bit machine. The program works well most of the time, but it occasionally freezes completely and the message "Internal Stack Overflow" shows up on the screen. I don't know what that means, and I haven't got the vaguest idea about how to prevent it. Can you help?—G. Ishbe, Friar, VT

I don't know what kind of software you're running, but the error message you're getting is from DOS, not the program. Stack overflows are operating-system errors that most frequently show up in programs that have a lot of interrupt-driven routines. But let's start at the beginning.

One of the characteristics of the 80XX series of microprocessors is that they can be told to drop everything they're doing and take care of something else. The signals that make the interruption of normal events take place are referred to as *interrupts*. These interrupts can be generated either by software or hardware, and are all handled, more or less, the same way by the microprocessor.

When an interrupt is received, the microprocessor stops what it's doing and runs the software routine whose starting address is stored in a table in memory. The interrupt table is simply a collection of locations that are built by both DOS and the program you're running at the time. Your problem is being caused by the way the microprocessor remembers where it was before it received the interrupt.

In order for the computer to suspend its current activities, do something else, and then return to where it originally left off, it has to store a bunch of information about where it was and what it was doing before

the interrupt occurred. The place it stores this stuff is called the *stack*.

The stack is simply a location in memory used by the computer for the temporary storage of the information it needs to be able to resume whatever it was doing before the interrupt occurred. Typical examples of interrupt activity would be things like dealing with parallel and serial ports, disk drives, and so on. When the computer has finished taking care of the interrupt, the information it needs is removed from the stack, and the stack space that was being used by that information is freed up and made available for the next interrupt.

When a piece of software is loaded with interrupt-driven routines and they're used frequently while the program is running, it's not only possible, but probable, that the computer will run out of stack space. If that happens, the computer will throw up its electronic hands and tell you that there's been an "Internal Stack Overflow."

Since the error can be trapped by software, the fact that you're getting it frequently is probably a flaw in the program and it should be corrected by the people who wrote it. I would call them and complain.

Another way to solve the problem is to increase the number and size of the stacks available to DOS by using the STACK statement in your CONFIG.SYS file. If that statement is absent, DOS will default to nine stacks of 128 bytes each. Try increasing the number of stacks to ten or more and see if the problem still occurs. The downside of this solution is that increasing the stacks cuts down the available memory, and that may affect the operation of the program as well.

All the information you need about the STACK command is in your DOS manual. If altering the default stack setup doesn't help you, the problem will have to be solved

by the people who wrote the program you're using.

NEW RADIO BLUES

After many years, I've replaced the radio in my car, and I'm having a problem with the speakers. My new radio is stereo and my old one was mono. For a variety of reasons, it's impossible to have stereo speakers in my car, so I want to combine the left and right outputs of the new radio and have them drive a single speaker. Even though my natural inclination is to simply twist the outputs together, I have a feeling that's not the right thing to do. Is there some simple way to do this or do I need more equipment?—B. Boynton, New York, NY

Whatever you're missing in terms of an electronics background, you're making up in common sense. Connecting both stereo outputs together at one speaker is what's known as a "bad idea." You can get away with that kind of stuff when you're dealing with line-level signals, but definitely *not* when you're playing around with the output of the power amp.

The good news is that you don't need a bunch of new equipment to do what you have in mind. All you need is a pair of resistors as shown in Fig. 1. Connecting the outputs

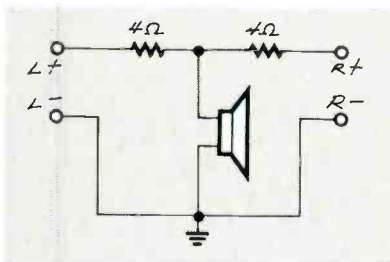
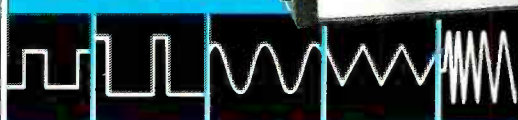

FIG. 1—TO CONNECT STEREO OUTPUTS TOGETHER, use a pair of resistors as shown here so that the two channels are isolated from each other.

directly together will cause one channel to drive the other and seriously damage the circuitry in the radio. By putting the resistors on the line, you're making sure that the two channels are isolated from each other, and that each one sees the proper load. R-E

Start Making Waves.



Switch to B+K PRECISION for the right function generator at the right price.

Don't let tight budgets keep you from the function generator performance you need. B+K PRECISION has the industry's most complete line of cost-effective generators...from 150 kHz to 13 MHz. All are rugged lab-grade instruments that will perform as promised, every time. Here are just two examples.

13 MHz Universal Function Generator with Frequency Counter

- 0.1 Hz to 13 MHz output
- Sine, square, triangle, ramp, pulse, triggered, gated burst, TTL outputs
- Two built-in generators can be used independently or together for AM or FM
- 1000:1 sweep range
- Variable symmetry for unlimited waveforms
- Built-in 30 MHz frequency counter

Model 3040 **\$1,195⁰⁰**

2 MHz Function Generator

- 0.2 Hz to 2 MHz
- Sine, square, triangle, ramp and TTL or CMOS output
- Four-digit frequency display
- Variable DC offset
- Variable symmetry

Model 3011B
\$259⁰⁰

For more information on the complete line of B+K PRECISION function generators or for immediate delivery, contact your local distributor or B+K PRECISION.



BK PRECISION
MAXTEC INTERNATIONAL CORP.

Domestic and International Sales
6470 W. Cortland St., Chicago, IL 60635
312-889-1448 • FAX: 312-794-9740

FOR SALES ASSISTANCE
CIRCLE 77 ON FREE INFORMATION CARD

FOR INFORMATION ONLY
CIRCLE 185 ON FREE INFORMATION CARD

NO COMPLICATED ELECTRONICS, NO EXPENSIVE INSTRUMENTS:

Home study course shows you how to make good money in VCR repair.

An amazing fact: you can do more than four out of five VCR repairs with ordinary tools and basic fix-it procedures. Our home study program shows you how.

Learn all of the systems, mechanisms, and parts of almost all brands of VCRs. With *no* expensive instruments. *No* complicated electronics. *No* fancy workshop. The step-by-step texts and close personal attention from your instructor make learning easy.



Texts, course materials, and tool kit are sent to your home. Graduate ready to make up to \$50.00 or more per hour in your own spare-time or full-time business.

Send today for your free career booklet. Or call 800-223-4542



Name _____
Address _____
City _____ State _____ Zip _____

The School of VCR Repair

2245 Perimeter Park, Dept. VA342 Atlanta, Georgia 30341

Rest assured, no scope was injured in the making of this ad.

After all, the volunteer is a member of our new TAS 400 family of analog oscilloscopes. And every TAS has its entire acquisition system (including the vertical, horizontal and trigger functions for each input channel) housed on a proprietary hybrid circuit.



The result is a kind of scope on a chip.

One with 75% fewer parts and far greater reliability. In fact, the TAS is three times more reliable than previous scopes.

What's more,
each and every
TAS

To demonstrate the value and durability of this amazing

comes with smashing features like AutoSet, on-screen cursors and readout, dual timebases, and save and recall settings. Plus a unique user interface that makes the 60 MHz TAS 455 and 100 MHz TAS 465 easier to use and dramatically unlike any other analog scope.

A claim that is further backed up by their remarkably affordable price.

But then a lot of performance for not a lot of money is exactly what the TAS is all about.

Scopes that add to a long list of low-cost Tektronix products. Like our handheld 60 MHz 224



digitizing oscilloscope.



Our fully programmable,

analog/digital 2212 scope. And our family of affordable and



stackable basic test gear.

Now that's a lot to

drop on you in one ad. So to learn more

about these and other economical

Tektronix products, call your

authorized Tektronix distributor today.

Or call us at (800) 426-2200, ext. 140

to place your order or for the

name of the distributor

nearest you.

new analog scope, we dropped it.

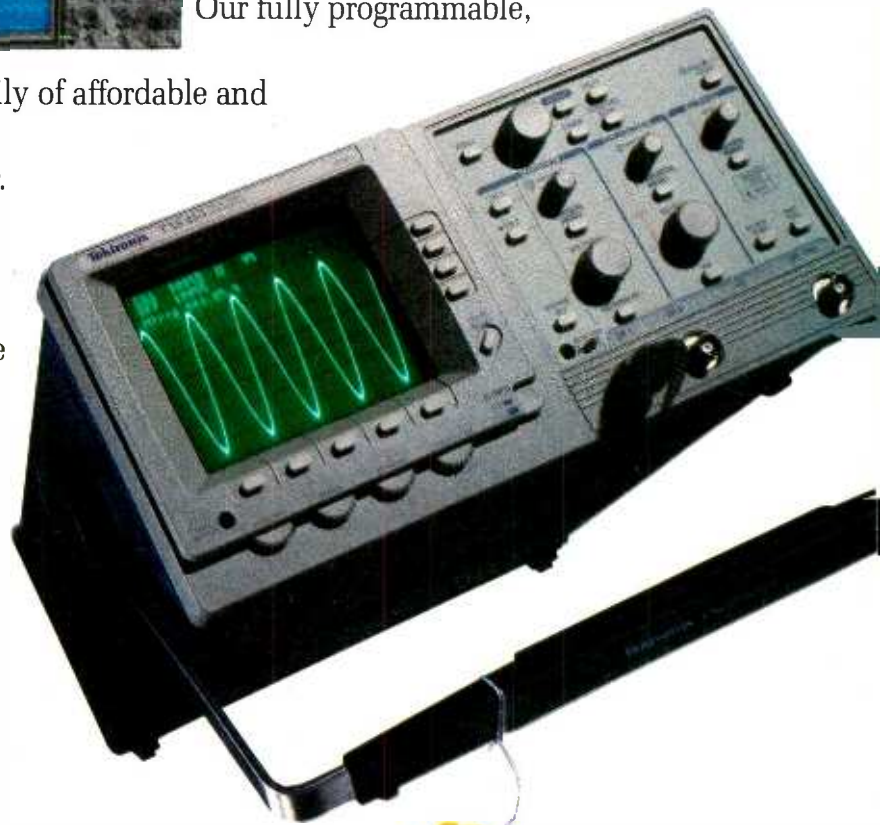

Tektronix

Test and Measurement

January 1993, Electronics Now

11

CIRCLE 92 ON FREE INFORMATION CARD

www.americanradiohistory.com

Write to Letters, *Electronics Now*, 500-B Bi-County Blvd., Farmingdale, NY 11735

NEW ADDRESS

The address and telephone number for TSW Electronics (the supplier for the "PC-Controlled Test Bench" series that started in June 1992) have changed. They can now be reached at 10751 Southwest 30th Place, Davie, FL 33328. (305) 452-1190.

DISKETTE DIFFERENCES

In the September issue of **Radio-Electronics**, there was an article in Q&A concerning the difference between the 3½-inch double-density (DD) and high-density (HD) diskettes. You anticipated a host of comments from industry experts. Here's one.

For the past 22 years, I have been designing flexible diskettes and their ancillary test equipment. I have designed 8-, 5¼-, and 3½-inch products for many major manufacturers. For three-and-a-half years, I worked for Sony Corporation to develop an industry standard that was adopted by the American National Standards Institute (ANSI), the European Computer Manufacturers Association (ECMA), and the International Standards Organization (ISO). During this time, I served as the chairman of the ANSI subcommittee that standardized the current PC format.

There are many good reasons why you should not punch the HD hole in DD diskettes, although there are some similarities between the two products. They share the same case (except for the extra hole and the silkscreened "HD"), and the magnetic media looks virtually the same. When the DD product was designed, there was no intent to use it for higher densities without some major changes. To double the density and be able to store 1.44 megabytes it is necessary that the coating thickness be reduced to about half that of the DD product.

The coercivity of the oxide was increased slightly to accommodate the higher recording frequency. It was also found out that we had to decrease the diameter of the hub to allow reliable recording at the innermost tracks. Those are not trivial changes, as some advertising would have you believe. Those changes were accompanied by many process changes to improve reliability. Those changes resulted in a requirement that the record current for HD be higher than for a DD product.

If you record a DD product using the HD record frequency and current, the recording will have greater peak shift and bit jitter. If you record and play back on one drive (and never plan to interchange data with another drive), and if you always keep your drive in top shape with frequent maintenance, you might not have any problem with punching holes in DD diskettes and recording them at HD densities. However, if you are among the vast majority of users who neglect their drives until they fail (as I do), you will most certainly have data failure.

WILLIAM B. PROCTOR
Cupertino, CA

RECYCLED TRANSFORMER

The "250-Watt Power Inverter" (**Electronics Now**, October 1992) looks like an ideal place for a transformer from a dead microwave oven. Those transformers are really rugged, readily available (when the oven dies, it is usually the magnetron or the digital control board failure that seals its fate), and easily converted for the low-voltage, high-current use.

Just remove the high-voltage and three-volt filament windings (a wood chisel carefully applied does it in about ten minutes with practice). Punch out the two magnetic shunts between the primary and the secondary. All of the transformers I

have wound take one turn per volt, which makes it easy to calculate the turns ratio. I just size the secondary wire to match the load requirement.

The transformer should provide about the same power output as the oven from which it came. For the power inverter, just use two 12-turn windings with 12 or 10 AWG wire and you are all set—and you save \$52.78.

Keep up the good work.
LLOYD HARTENBERGER
Chester, IL

DIGITAL TACH FOR DIESEL CAR

In the November issue of **Radio-Electronics/Electronics Now** in Q&A Mr. J. Hewitt of Florida, NY was looking for a way to hook up a digital tachometer to his diesel car. He stated that he had put a disk with holes around the circumference of the alternator and was using an optical pickup.

It appears to me that he was overlooking the forest just to see a tree. The alternator is an excellent signal source to drive a tachometer. However, he will need to go inside the alternator and attach a diode to the junction where the stators feed the rectifier diodes, run the other lead of the diode out of the alternator through some kind of insulated feed-through to his tachometer circuit. (Hook up the diode to give the desired polarity of the signal to drive his circuit.) The number of pulses per second will depend on the crankshaft speed, ratio of the crankshaft to alternator-pulley diameters, and the number of poles in the alternator.

If there's access to the teeth on the flywheel, this is another excellent source of pulses. It requires that a magnetic pickup be placed in close proximity to the flywheel teeth to detect each tooth as it passes the pickup.

DUANE L. MITCHELL
Trivoli, IL

R-E

Graduate as a Fully Trained Electronics Professional!

If you want to learn about electronics, and earn a good income with that knowledge, then CIE is the best educational value you can receive.

CIE's reputation as the world leader in home study electronics is based solely on the success of our graduates. And we've earned our reputation with an unconditional commitment to provide our students with the very best electronics training.

Just ask any of the 150,000-plus graduates of the Cleveland Institute of Electronics who are working in high-paying positions with aerospace, computer, medical, automotive and communications firms throughout the world.

They'll tell you success didn't come easy...but it did come...thanks to their CIE training. And today, a career in electronics offers more rewards than ever before.

CIE'S COMMITTED TO BEING THE BEST...IN ONE AREA...ELECTRONICS.

CIE isn't another be-everything-to-everyone school. CIE teaches only one subject and we believe we're the best at what we do. Also, CIE is accredited by the National Home Study Council. And with more than 1,000 graduates each year, we're the

largest home study school specializing exclusively in electronics. CIE has been training career-minded students like yourself for nearly sixty years and we're the best at our subject....ELECTRONICS...BECAUSE IT'S THE ONLY SUBJECT WE TEACH!

CIE PROVIDES A LEARNING METHOD SO GOOD IT'S PATENTED.

CIE's AUTO-PROGRAMMED® lessons are a proven learning method for building valuable electronics career skills. Each lesson is designed to take you step-by-step and principle-by-principal. And while all of CIE lessons are designed for independent study, CIE's instructors are personally available to assist you with just a toll free call. The result is practical training... the kind of experience you can put to work in today's marketplace.

LEARN BY DOING...WITH STATE-OF-THE-ART EQUIPMENT AND TRAINING.

CIE pioneered the first Electronics Laboratory Course and the first Microprocessor Course. Today, no other home study school can match CIE's state-of-the-art equipment and

training. And all your laboratory equipment, books and lessons are included in your tuition. It's all yours to use while you study and for on-the-job after you graduate.

PERSONALIZED TRAINING....TO MATCH YOUR BACKGROUND.

While some of our students have a working knowledge of electronics others are just starting out. That's why CIE has developed twelve career courses and an A.A.S. Degree program to choose from. So, even if you're not sure which electronics career is best for you, CIE can get you started with core lessons applicable to all areas in electronics. And every CIE Course earns credit towards the completion of your Associate in Applied Science Degree. So you can work toward your degree in stages or as fast as you wish. In fact, CIE is the only school that actually rewards you for fast study, which can save you money.

SEND FOR YOUR CIE COURSE CATALOG AND WE'LL SEND YOU A FREE 24-PAGE CIE ELECTRONIC SYMBOLS HANDBOOK.

FREE!

SEND FOR YOUR CIE HOME STUDY COURSE CATALOG AND RECEIVE A FREE 24 PAGE CIE ELECTRONIC SYMBOLS HANDBOOK!

Includes hundreds of the most frequently used electronic symbols. Published exclusively by CIE for our students and alumni. Yours free when you request a CIE Course Catalog.

electronics



YES! I want to get started. Send me my CIE course catalog including details about the Associate Degree Program. (For your convenience, CIE will have a representative contact you - there is no obligation.)

AE46

Please print clearly

Name _____

Address _____

City _____ State _____

Zip _____ Age _____

Phone No. (____) _____

Check box for G.I. Bill Benefits

Veteran Active Duty



1776 East 17th Street
Cleveland, Ohio 44114

A School of Thousands.
A Class of One. Since 1934.

EQUIPMENT REPORTS

1992 IC Master CD-ROM Plus



If you need to find an integrated circuit that can do a given job, there's really only one place to go: The IC Master from Hearst Business Communications, Inc (645 Stewart Avenue, Garden City, NY 11530). We find the IC Master to be indispensable. It lets us search for data on a device by part number or function. It helps us identify integrated circuits, and to find available alternate sources for devices. We can get addresses for chip manufacturers and their closest distributors, and pore through the data-sheet pages for new devices.

Although we've always thought that the IC Master was irreplaceable, we've found something that might just replace it: The IC Master CD-ROM Plus. (We examined the 1992 version; the 1993 disc should be available in the first quarter of 1993.) Hurst has taken all of the information contained in their 3-volume paper reference (more than 3700 pages' worth) and put it in on a single compact disc. They've also added the information from Hearst's Directory of Manufacturers' Data Pages, which lists the specific manufacturer's data book in which a particular device is covered.

The IC Master CD-ROM Plus requires as a minimum platform an IBM PC XT or compatible computer with 640 kilobytes of RAM and EGA graphics capability. A hard disk is required to store temporary sort files, and a Hewlett-Packard Laser

Jet or compatible printer is required for printing data-sheet images and other specifications.

In the simplest case, the IC Master requires virtually no setup. We just inserted the disc into our CD-ROM reader, made it the default drive, and typed in "ICMASTER." We were greeted by Hearst's opening screen, and then the main menu.

The main menu, across the top of the screen, presents six options: FILE, INFO, SEARCH, DEVICE, SORT, and PRINT. You can pull down each of the six menus to reveal more options. (A mouse is not supported.)

The File menu provides six functions. You can save the current search information or load previously saved searches. On multiple-user systems, you can login our logout, or get a list of current inquiries. The File menu also lets you exit the IC Master and return to DOS.

The Info menu lets you find information on all manufacturers in the IC master. Address, phone and fax numbers, sales offices, distributors and much more are included. There's also a simple text editor that lets you pull data from the disc and insert it automatically into your text file, which can be up to forty lines. The Info submenus also let you create lists of applications notes and military parts, and find alternate sources by device number.

The search menu lets you search for devices by the type of device, by manufacturer, by base number, mili-

tary temperature, or whether it is a surface-mount device. Boolean operators (AND, OR, NOT) can be used to create your search.

The Device menu lets you access information on the current device—that is, the device that your search has found. You can see device specifications, whether application notes or alternate sources are available for the current device, and whether data sheets are available on disc.

The Sort menu lets you arrange the results of your device searches—both rows and columns can be sorted. The Print menu lets you output your search results or the specifications of the current device to your printer or to a disk file.

We found the system reasonably easy to use. One exception is the way that data sheets are displayed on-screen. The on-screen resolution of the data-sheet image must be selected when you load the program—you can't change it once you start. (We couldn't change the on-screen resolution even following the manual's instructions.) The data-sheet images are always printed at full resolution. We printed a variety of data sheets; they usually looked like good laser faxes.

Our only real complaint about the IC Master CD-ROM Plus is its price: \$495. The three-volume paper version costs less than \$200, and the Directory of Manufacturers' Data Pages is less than \$100. Although scanning data sheets can be an expensive proposition, (even though Hearst didn't add any "clean-up" work to make the on-screen images more readable) we estimate that the costs of producing the CD-ROM version should be less than the paper version. Even so, we're sure that there are some people who will find the potential time savings of the CD-ROM worth the premium price—especially networked users who might find the cost to be competitive with buying multiple copies of the IC Master. **R-E**

Electronic Paperbacks at Special Prices

BP325—A CONCISE USER'S GUIDE TO WINDOWS 3.1 \$7.95. Come to grips with Windows 3.1 in the shortest and most effective way. Learn how to manipulate Windows screens and DOS by Windows graphics interface. Master its word processor, Paintbrush and data base along with Notepad, Macro Recorder, PIF Editor, and Calculator.

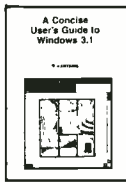

BP311—AN INTRODUCTION TO SCANNERS AND SCANNING \$7.95. Radio scanners have opened a realm of exciting radio listening. Understand radio wave propagation, types of transmissions, antennas, band assignments—the straight dope on what to hear and where to hear it! Comes complete with index, glossary of important terminology.



BP287—A REFERENCE GUIDE TO PRACTICAL ELECTRONICS TERMS \$8.95. More than just a dictionary of practical electronics terms, the book goes a step further in getting down to fundamentals. A reference volume that can be read casually by a reader seeking knowledge.

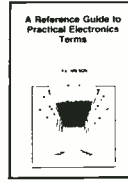

BP248—TEST EQUIPMENT CONSTRUCTION \$5.95. Details construction of simple, inexpensive, but extremely useful test equipment. AF Gen, Test Bench Ampl, Audio Millivoltmeter, Transistor Tester and six more.



BP267—HOW TO USE OSCILLOSCOPES AND OTHER TEST EQUIPMENT \$6.95. Mastering the oscilloscope is not really too difficult. This book explains all the standard controls and functions. Other equipment is also described.



BP265—MORE ADVANCED USES OF THE MULTIMETER \$5.95. Use these techniques to test and analyze the performance of a variety of components. Also see how to build add-ons to extend multi-meter capabilities.



BP256—INTRO TO LOUDSPEAKERS AND ENCLOSURE DESIGN \$5.95. We explore the variety of enclosure and speaker designs in use today, so the reader can understand the principles involved.

CMOS1—CMOS POCKET GUIDE 1 \$18.95. Works like the TTL Guides but covers all commonly used CMOS standard devices. Six major sections. The first shows the device schematic. Next is a brief description of the component and is followed by full operating details. The fourth section lists major applications, while the 5th and 6th sections present essential data for that device and a list of the relevant manufacturers. The final two sections are a valuable cross-reference.



BP299—PRACTICAL ELECTRONIC FILTERS \$6.95. Presents a dozen filter-based practical projects with applications in and around the home or in the constructor's workshop. Complete construction details are included.



BP249—MORE ADVANCED TEST EQUIPMENT CONSTRUCTION \$6.95. Eleven more test equipment construction projects. They include a digital voltmeter, capacitance meter, current tracer, etc.



BP245—DIGITAL AUDIO PROJECTS \$5.95. Practical circuits to build and experiment with. Includes A/D converter, input amplifier, digital delay line, compander, echo effect and more.



BP247—MORE ADVANCED MIDI PROJECTS \$5.95. Circuits included are a MIDI indicator, THRU box, merge unit, code generator, pedal, programmer, channelizer, and analyzer.



BP257—INTRO TO AMATEUR RADIO \$6.95. Amateur Radio is a unique and fascinating hobby. This book gives the newcomer a comprehensive and easy to understand guide to the subject.

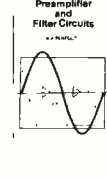

BP309—PREAMPLIFIER AND FILTER CIRCUITS \$6.95. Provides circuits and background info for a range of preamplifiers, plus tone controls, filters, mixers and more. All are high-performance circuits that can be built at a reasonable cost.

BP303—UNDERSTANDING PC SOFTWARE \$6.95. This book will help you understand the basics of various types of business software in common use. Types of software covered include word processors, spelling checkers, graphics programs, desktop publishing, databases, spreadsheets and utilities.



BP251—COMPUTER HOBBYISTS HANDBOOK \$8.95. A wrapup of everything the computer hobbyist needs to know in one easy to use volume. Provides a range of useful reference material in a single source.



PCP115—ELECTRONIC PROJECTS FOR HOME SECURITY \$10.00. 25 projects ranging from a single-door protection circuit that can be completed in an hour or two, to a sophisticated multi-channel security system. Each project is described in detail with circuit diagrams, explanations of how it works, instructions for building and testing, and how to adapt circuits to meet special requirements.



BP190—ADVANCED ELECTRONIC SECURITY PROJECTS \$5.95. Includes a passive infra-red detector, a fiber-optic loop alarm, computer-based alarms and an unusual form of ultrasonic intruder detector.

BP235—POWER SELECTOR GUIDE \$10.00 Complete guide to semiconductor power devices. More than 1000 power handling devices are included. They are tabulated in alpha-numeric sequence, by technical specs Includes power diodes, Thyristors, Triacs, Power Transistors and FETs.

BP234—TRANSISTOR SELECTOR GUIDE \$10.00. Companion volume to BP235. Book covers more than 1400 JEDEC, JIS, and brand-specific devices. Also contains listing by case type, and electronic parameters, includes Darlington transistors, high-voltage devices, high-current devices, high power devices.

BP117—PRACTICAL ELECTRONIC BUILDING BLOCKS—Book 1 \$5.75. Oscillators, Timers, Noise Generators, Rectifiers, Comparators, Triggers and more.

BP195—INTRODUCTION TO SATELLITE TV \$9.95. A definitive introduction to the subject written for the professional engineer, electronics enthusiast, or others who want to know more before they buy. 8 x 10 in.

BP179—ELECTRONIC CIRCUITS FOR THE COMPUTER CONTROL OF ROBOTS \$7.50. Data and circuits for interfacing the computer to the robot's motors and sensors

BP239—GETTING THE MOST FROM YOUR MULTIMETER \$5.95. Covers basics of analog and digital meters. Methods of component testing includes transistors, thyristors, resistors, capacitors and other active and passive devices.

BP97—IC PROJECTS FOR BEGINNERS \$5.50. Power supplies, radio and audio circuits, oscillators, timers, switches, and more. If you can use a soldering iron you can build these devices.

RADIO—100 RADIO HOOKUPS \$3.00. Reprint of 1924 booklet presents radio circuits of the era including regenerative, neutrodyne, reflex & more.

BP42—SIMPLE LED CIRCUITS \$5.50. A large selection of simple applications for this simple electronic component.

BP122—AUDIO AMPLIFIER CONSTRUCTION \$5.75. Construction details for preamps and power amplifiers up through a 100-watt DC-coupled FET amplifier.

BP92—CRYSTAL SET CONSTRUCTION \$5.50. Everything you need to know about building crystal radio receivers.

BP255—INTERNATIONAL RADIO STATIONS GUIDE \$7.95. Provides the casual listener, amateur radio DXer and the professional radio monitor with an essential reference work designed to guide him or her around the more than ever complex radio bands

CHECK OFF THE BOOKS YOU WANT

ELECTRONIC TECHNOLOGY TODAY INC.
P.O. Box 240, Massapequa Park, NY 11762-0240

Name _____
Address _____
City _____ State _____ Zip _____

SHIPPING CHARGES IN USA AND CANADA

\$0.01 to \$5.00	\$1.50
\$5.01 to \$10.00	\$2.50
\$10.01 to 20.00	\$3.50
\$20.01 to 30.00	\$4.50
\$30.01 to 40.00	\$5.50
\$40.01 to 50.00	\$6.50
\$50.01 and above	\$8.00

SORRY No orders accepted outside of USA & Canada

Total price of merchandise	\$ _____
Shipping (see chart at left)	\$ _____
Subtotal	\$ _____
Sales Tax (NY State only)	\$ _____
Total Enclosed	\$ _____

Number of books ordered

All payments must be in U.S. funds

EN193

NEW PRODUCTS

Use the Free Information Card for more details on these products.

RCL METER. A new meter will give incoming inspection and quality-control personnel responsible for passive electronic components a tool for faster testing. Fluke's *PM 6304 Automatic RCL Meter* includes such options as RS-232 GPIB interfaces, component binning, DC resistance measurements, and component-testing software. The new unit is a "big brother" to the *PM 6303A RCL meter*, and it features the same easy-to-read LCD readout and automatic operation, plus improved basic measurement capability and remote programmability. The unit offers 204 test frequencies from 50 Hz to 100 kHz, 0.1% basic accuracy, front-panel set-ups in memory, measurement rates up to 10 readings per second, and selectable 2-volt, 1-volt, and 50-mV test levels.

The "Inspector" PC-based software package features such functions as instrument programming and setup, automation of the data collection process, save and recall of component data from mass storage and component analysis using histograms.

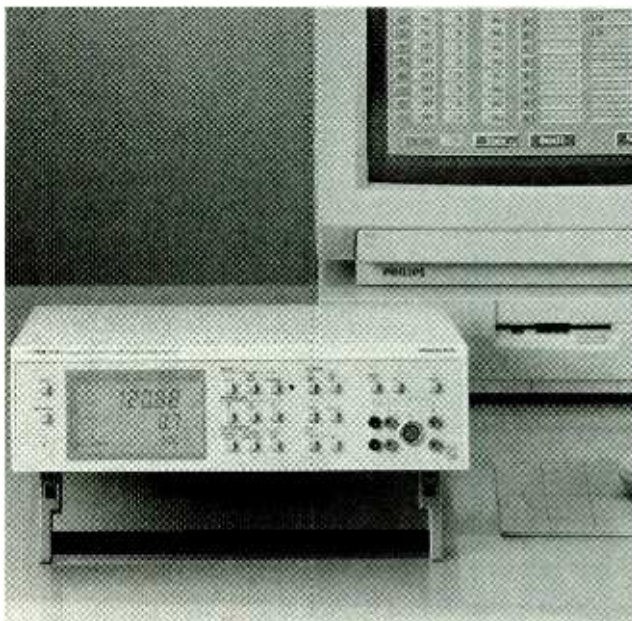

CIRCLE 16 ON FREE INFORMATION CARD

Others are simple statistics and plotting, and controlling and setting up the component binning function. The data collected can be exported in standard Lotus 1-2-3 or Excel formats for statistical quality control programs. The *PM 6304* connects to a PC via optional IEEE-488 or RS-232 interfaces.

The binning feature sorts electronic components into as many as 10 bins to maintain tighter control tol-

erances for critical component values. The RCL meter includes a separate interface card with lamp-driver outputs to connect to component bins, as well as a trigger input for operator-initiated measurements.

The *PM 6304 RCL Meter* has a list price of \$2195.

John Fluke Mfg. Co., Inc.
P.O. Box 9090, M/S 250-E
Everett, WA 98206.
Phone: 800-44-FLUKE.



CIRCLE 17 ON FREE INFORMATION CARD

ference between the measured and reference component values. Two selectable test frequencies (120 Hz and 1 kHz) are available, and the user can switch between auto and manual ranging. The LCR bridge comes with a pair of test leads, an AC adapter, and an instruction manual.

The *Model 878 LCR Bridge* has a list price of \$275.

B + K Precision
6470 West Cortland Street
Chicago, IL 60635
Phone: 312-889-1448
Fax: 312-794-9740

DC POWER SUPPLIES. A series of compact single-, dual-, and triple-output DC power supplies from *Protek* includes power-saving circuitry to assure cooler operation. The series consists of four models, each offering precise current-limiting and voltage setting functions, and incorporating two 3-digit LED readouts for simultaneous monitoring of operational status. The red LED's indicate current and the green LED's indicate voltage.

LCR BRIDGE WITH STATISTICAL FUNCTIONS. The *Model 878 LCR bridge* offers the features of an expensive bench bridge at the price of a handheld capacitance meter. According to *B + K Precision*, it is the first handheld LCR Bridge to simultaneously

display measured inductance or capacitance with Q or dissipation factor. It is the first to remember minimum and maximum tested components values, and calculate a running average, and the first to let the user select a 1%, 5%, or 10% tolerance around a ref-

erence value. The meter beeps when a component is out of tolerance.

The *Model 878* measures capacitance, resistance, and inductance with accuracy comparable to that of more expensive benchtop models. Its relative mode displays the dif-

They also provide overload indication. The "energy saver" circuit automatically lowers the power ratio of the main transformer component when the output is



CIRCLE 18 ON FREE INFORMATION CARD

set between preset limits.

The *Model 3003* is rated at 0–30 volts, 3 amps. The *Model 3006* is rated at 0–60 volts, 1.5 amps. The dual-output *Model 3015* combines two regulated output circuits in the same housing, with each unit isolated for independent, parallel, or series operation. Each has ratings of 0–30 volts and 0–1.5 amps. The triple-output *Model 3033* has two independently vari-

able outputs rated at 0–30 volts, 1.5 amps, and a third fixed output of 5 volts, 5 amps. That model also has tracking capability for its two main outputs and is said to be ideal for working with differential amplifiers. Each unit is supplied with three 5-way output binding posts, coarse and fine voltage controls, and a set of cables.

The models 3003 and 3006 cost \$249; 3015 costs \$429; and 3033 costs \$499.

Protek, Inc.

P.O. Box 59
Norwood, NJ 07648
Phone: 201-767-7242
Fax: 201-767-7343

12-VOLT SOLDERING IRON.

For making emergency repairs or working in the field on cars, boats, or model airplanes, the *Antex Model MLXS-12 Auto Repair Kit*

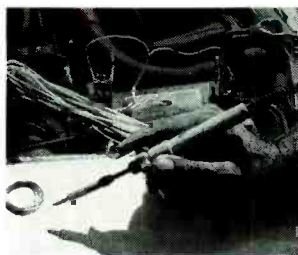

CIRCLE 19 ON FREE INFORMATION CARD

from *M.M. Newman* features an industrial-grade soldering iron that operates from automotive or marine 12-volt batteries. Equipped with a 15-foot cord for mobility and two large alligator clips, it connects easily to the battery terminals. The iron heats up to 800°F in less than two minutes, and has its heating element located directly under the tip for optimum thermal efficiency. That design keeps the handle cool for user comfort. A finger support helps

improve soldering control. The kit also includes a tip, a supply of solder, and a plastic carrying pouch.

The *Antex Model MLXS-12 Auto Repair Kit* costs \$31.95.

M.M. Newman Corporation
24 Tioga Way, P.O. Box 615
Marblehead, MA 01945
Phone: 617-631-7100
Fax: 617-631-8887

MAGNETIC LONGWIRE BALUN.

The *Model MLB-1 magnetic longwire balun* from *Palomar Engineers* clears up noise picked up on the feedline of long random-wire antennas. The typical longwire is usually strung above household noise sources, but the single wire that connects the antenna to the radio drops down near the computers, light-dimmers, TV's, fluorescent lights, and other sources of noise. It picks

Train at HOME to be an Electronics Technician!

As the demand for computers and microprocessors in business, manufacturing and communications continues to grow, so does the need for qualified technicians. It's not unusual for experienced technicians to earn from \$30,000 to more than \$40,000 a year.* Now through Peoples College of Independent Studies you can train for this exciting field without interrupting your job or home life.

Choose From Five Programs of Study

- Electronics & Microprocessor Technology
- Industrial Electronics & Microprocessor Technology
- Communications Electronics with Microprocessor Technology
- Computer Servicing & Electronics Technology
- Specialized Associate Degree In Electronics Technology

Professional Equipment Is Included

Depending on the program you select, you'll perfect your skills using this advanced equipment, included in the price of tuition:

- IBM-Compatible Personal Computer
- Digital Multimeter
- Digital Logic Probe
- Elenco Oscilloscope
- Portable Cellular Telephone

(* Source: U.S. Bureau of Labor Statistics)



Exclusive Extras That Enhance Your Training

Peoples College introduces some training firsts to make your learning experience more complete:

- Accelerated Learning System — a scientifically proven study system that helps you learn faster and easier than ever before.
- Video Tutor Training Tapes — give you a permanent, visual record of informative lectures and close-up demonstrations.
- Experience Labs — professionally designed experiments that give you hands-on "bench" experience.
- Industry Certification Training Guide — provided with four of our programs. Prepares you for examinations you may take for your professional license or certification.

Easy Payment Plans — No Finance Charges

To help you get started on your education, Peoples College has reduced tuition rates and offers low monthly payment plans with no finance fees. So don't delay, call or write for more information today!

For COLOR CATALOG Mail Coupon or Call TOLL FREE 1-800-765-7247

Programs offered only in United States, Canada, Puerto Rico and Virgin Islands. No Obligation. No sales person will call.

Our programs are accredited by the Accrediting Commission of the National Home Study Council

✂

YES! I would like to know more about your training programs. Send a catalog to:

Name _____

Address _____

City _____

State _____ Zip _____

Phone # _____

PEOPLES COLLEGE
OF INDEPENDENT STUDIES
233 Academy Drive • P.O. Box 421768
Kissimmee, FL 34742-1768
Member, D.I. Peoples Group R193

CIRCLE 179 ON FREE INFORMATION CARD



CIRCLE 20 ON FREE INFORMATION CARD

up that noise and adds it to the wanted shortwave signals.

By contrast, the *MLB-1* connects at the antenna and allows the use of shielded coaxial cable between the antenna and the radio. Coaxial cable does not pick up the noise, and permits much quieter reception in noisy locations. The balun, for reception only, works from 500 kHz to 30 MHz. An eyebolt on top of the balun supports it from the antenna's end insulator. A Teflon-insulated wire on the side connects to the antenna. A connector is provided for the coaxial cable, which is not supplied. The balun is completely weather-proof and requires no electrical power.

Model *MLB-1* costs \$39.95, plus \$4 shipping in the U.S. and Canada.

Palomar Engineers

P.O. Box 462222
Escondido, CA 92046
Phone: 619-747-3343
Fax: 619-747-3346

DIGITAL OUTPUT CARD.

Global Specialties' Model DOP-24 is a digital output card with Darlington drivers that allows relays, solenoids, stepper motors, or lamps to be driven directly in control applications. All channels are opto-isolated, protecting both the card and the PC from problems due to accidental wiring.

The card provides 24 opto-isolated Darlington

outputs, suitable for driving DC loads in the range of 5–24 volts at currents up to 400 milliamps per channel. The maximum output power of the card is limited to two watts, which the manufacturer says is sufficient to drive most output devices. Increased output power can be obtained by adding external relays or conditioners to handle larger loads.

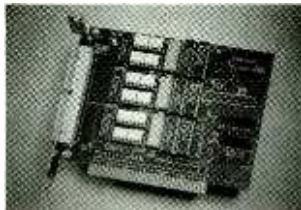

CIRCLE 21 ON FREE INFORMATION CARD

The board is bit-mapped and appears as three consecutive 8-bit ports. Any common programming language can be used to drive the card simply by setting a binary pattern in the appropriate port. The short card format occupies a standard PC I/O port. A 50-way insulation displacement connector is provided on the rear panel for signal connections. Access to individual channels through individual screw terminals is available with the optional *ST-24* terminal block. Program examples and full documentation are included with each card.

The *Model DOP-24* costs \$195.

Global Specialties

70 Fulton Terrace
New Haven, CT 06512
Phone: 1-800-572-1028

ESD-SAFE IC STORAGE SYSTEM.

For storing, transporting, and archiving IC components, *iToi Enterprises* has introduced a new series of *ChipSafe* products that adds static-protection materials and reinforced structure. The interlocking, snap-fastened,

thermoformed plastic trays of the *X50* cases provide a protective, sealed enclosure for stored components. Trays are lined with a non-partitioned layers of 1/4-inch thick foam. Heavy-weight press-board panels between internal and external surfaces make up the body of the album. All of the new *X50* models have a clear, fully sealed, external covers made of permanent static-dissipating plastic. In addition, all internal surfaces are coated with a durable, topical anti-static agent that is resistant to abrasion. A reinforced "scrim" spine insert made of woven polyester mesh is



CIRCLE 22 ON FREE INFORMATION CARD

sealed in the spine to extend the hinge life of the products.

The *ChipSafe X50* IC storage albums range in price from \$7.95 to \$18.95.

iToi Enterprises

P.O. Box 59
Newton Highlands, MA 02161
Phone: 617-332-1010

SURGE PROTECTORS.

Intermatic's Electra Guard line of six-outlet surge protectors, in a variety of different models, continuously monitor the incoming power line, cable TV line, or phone line. They operate only when a surge or spike occurs. The surge suppressor responds in less than a nanosecond by absorbing the overload while allowing normal voltage to pass through. After the surge passes, the unit au-

tomatically resets to its monitoring mode. Several models are equipped with audible alarms that warn users if the unit needs to be replaced. Plug-in outlets for protecting phone lines, fax machines, personal computers, and modems are also standard on some models.

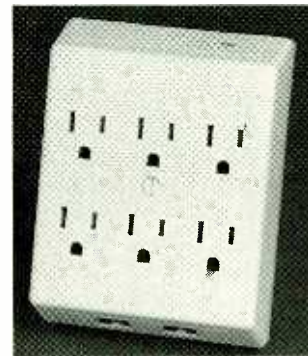

CIRCLE 23 ON FREE INFORMATION CARD

Intended to safeguard electronic equipment, the *EG63C* provides heavy-duty protection and broadband noise filtering. Model *EG63AC* adds an audible alarm. The *EG63EC* TV and VCR surge protector features built-in coaxial cable protection. It offers EMI/RFI noise filtering and is sold with a six-foot, 75-ohm cable. The *EG63TAC* fax and phone surge protector (pictured) has built-in modular phone jacks to provide maximum protection for fax machines, electronic phone systems, answering machines, and modems. The *EG65AC* offers maximum protection for personal computers and sensitive office equipment. It has a clamping level of 330 volts with multi-stage protection. It also features broadband noise filtering and an audible alarm.

The *Electra Guard* surge protectors range in price from \$15.95 to \$34.95.

Intermatic Inc.

Intermatic Plaza
Spring Grove, IL 60081

DSP56001 EMULATOR.

Domain Technologies' LINK-56001 is a true emulator with symbolic, source-level debugging for the Motorola DSO56001. The unit's probe emulates all of the DSP56001's pins, addresses, and resources, and provides full-speed emulation and monitoring. Bug-trapping features include slow-motion, break-and-run, single stepping, jump-over-call, break-on-data, conditional breaks, and save-on-break. With character graphics, a block of memory can be displayed graphically on the screen. Data can be displayed on the monitor in decimal, hexadecimal, fractional, binary, and ASCII formats.

LINK-56001 uses Motorola's DSP56002 to emulate the DSP56001, with the on-chip emulation



CIRCLE 24 ON FREE INFORMATION CARD

debug port controlling the SDP56002. A real-time hardware breakpoint can be set on data-read, data-write, program-fetch, program-read, and address-range. Source level, C, assembly, and mixed debugging are supported. The debugger's integrated interface has an on-line assembler/disassembler/data-editor. LINK-56001 includes mouse support, pulldown menus, color windows, and a variety of time-saving features. The device interfaces with the host PC through an included high-speed RS-232 link.

The LINK-56001 de-

velopment system package, which includes the debugger (on 3.5 and 5.25-inch disks), the emulator unit, a probe, RS-232 cable, an emulation port cable, a power supply, and a user's manual, is priced at \$2800.

Domain Technologies, Inc.
1621 Scottsdale Drive
Plano, TX 75023
Phone: 214-985-7593
Fax: 214-867-1739

800-MHz ANTENNA. One usually thinks of a Yagi antenna as an assembly of folded dipole, folded reflector, and a series of straight directors. But what about one that is an assembly of a bunch of loops on a bar? MAX System Antennas has just introduced a high-gain Yagi with 11 loop elements distributed along a bar.

The company says that

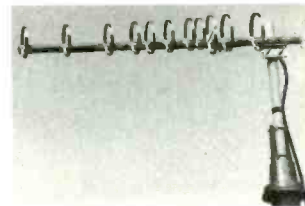

CIRCLE 25 ON FREE INFORMATION CARD

their new antenna has advantages over the conventional Yagi array. The antenna is said to give clear reception for weak 800- to 900-MHz signals. According to the manufacturer, no soldering or assembly is required to erect the antenna; all that's required is a cable terminated in a type-N connector. A free cellular-frequency chart is included with each purchase.

The Loop Yagi is priced at \$75.—**MAX System Antennas**, Cellular Security Group, 4 Gerring Road, Gloucester, MA 01930; Phone: 800-487-7539. **R-E**



HM8130

**A new breakthrough
in price/performance ratio**

- Synthesized Function Generator; 10MHz to 10MHz
- 5 Standard waveforms; Sweep mode; Ext. Gating
- Arbitrary function with 1024 x 1024 points; Interval 100ns
- Optional: GPIB/RS232 interfaces; External Keypad

See us at WESCON/92 Booth 2450

Call toll free
800.247.1241

HAMEG®
Instruments

1939 Plaza Real
OCEANSIDE, CA 92056
Phone (619) 630-4080
Telefax (619) 630-6507

Learn to troubleshoot and service today's computer systems as you build a 386sx/20 MHz mini tower computer!

Train the NRI way—and learn to service today's computers as you build your own 386sx computer system, now with 1 meg RAM, 40 meg IDE hard drive, and exciting new diagnostic hardware and software!

Jobs for computer service technicians will almost double in the next 10 years according to Department of Labor statistics, making computer service one of the top growth fields in the nation.

Now you can cash in on this exciting opportunity—either as a full-time industry technician or in a money-making computer service business of your own—once you've mastered electronics and computers the NRI way.

NRI's practical combination of "reason-why" theory and hands-on building skills starts you with the fundamentals of electronics, then guides you through more sophisticated circuitry all the way up to the latest advances in computer technology.

Train with and keep a powerful 386sx/20 MHz computer system plus popular Microsoft® Works software!

Only NRI gives you hands-on training with the finest example of state-of-the-art technology: the powerful new West Coast 386sx/20 MHz mini tower computer. As you assemble this 1 meg RAM, 32-bit CPU computer from the keyboard up, you actually see for yourself how each section of your computer works.

You assemble and test your computer's "intelligent" keyboard, install the power supply and 1.2 meg, high-density floppy disk drive, then interface the high-resolution monitor.

Your hands-on training continues as you install a powerful new 40 meg IDE hard disk drive—now included in your course to dramatically increase the data storage capacity of your computer while giving you lightning-quick data access.



NEW!
386sx/20 MHz
Mini Tower
Computer



Plus you now go on to work with today's most popular integrated software package, Microsoft Works, learning to use its word processing, spreadsheet, database, and communications utilities for your own personal and professional applications. But that's not all.



Only NRI gives you hands-on training with the remarkable R.A.C.E.R. plug-in diagnostic card and QuickTech diagnostic software from Ultra-X—professional, state-of-the-art diagnostic tools that make computer troubleshooting fast and accurate.

Your NRI computer training includes all this: • NRI's unique Discovery Lab® for circuit design and testing • Hand-held digital multimeter with "talk-you-through" instructions on audio cassette • Digital logic probe that lets you visually examine computer circuits • The new West Coast 386sx/20 MHz computer system, featuring a high-speed 80386sx CPU, 1 meg RAM, 101-key "intelligent" keyboard, 1.2 meg high-density floppy drive, and high-resolution monitor • 40 meg IDE hard drive • MS-DOS, GW-BASIC, and Microsoft Works software • R.A.C.E.R. plug-in diagnostic card and QuickTech menu-driven diagnostic software • Reference manuals with guidelines and schematics



printer ports, serial communications ports, video display memory, floppy drives, and hard disk drives.

Only NRI gives you such confidence-building, real-world experience. Only NRI gives you both the knowledge and the professional tools to succeed as today's in-demand computer service technician.

No experience needed ... NRI builds it in

NRI training gives you practical, hands-on experience that makes you uniquely prepared to take advantage of today's opportunities in computer service.

You learn at your own convenience in your own home. No classroom pressures, no night school, no need to quit your present job until you're ready to make your move. NRI starts you with the basics, building on that foundation step by step until you have the knowledge and skills you need for success.

And all throughout your training you've got the full support of your personal NRI instructor and the entire NRI technical staff, always ready to answer your questions and help you achieve your training goals.

FREE catalog tells more. Send today!

Send today for NRI's big, free catalog that describes every aspect of NRI's innovative computer training, as well as hands-on training in other growing high-tech career fields.

If the coupon is missing, write to:
NRI School of Electronics, McGraw-Hill
Continuing Education Center, 4401 Connecticut Avenue,
NW, Washington, DC 20008.

NOW! Training now includes Ultra-X diagnostic hardware and software for quick, accurate troubleshooting!

Now you train with and keep the latest in diagnostic hardware and software: the extraordinary R.A.C.E.R. plug-in diagnostic card and QuickTech diagnostic software, both from Ultra-X. Using these state-of-the-art tools, you learn to quickly identify and service virtually any computer problem on XT, AT 80286/80386, and compatible machines.

You discover how to use the R.A.C.E.R. diagnostic card to identify individual defective RAM chips, locate interfacing problems, and pinpoint defective support chips. Plus you learn to use your QuickTech diagnostic software to test the system RAM and such peripheral adapters as parallel

NEW!
386sx



IBM is a registered trademark of International Business Machines Corp. R.A.C.E.R. and QuickTech are registered trademarks of Ultra-X, Inc.

SEND TODAY FOR FREE CATALOG

NRI

McGraw-Hill Continuing Education Center
4401 Connecticut Avenue, NW
Washington, DC 20008



- Check one FREE catalog only
- MICROCOMPUTER SERVICING
 - TV/Video/Audio Servicing
 - Telecommunications
 - Industrial Electronics
 - Security Electronics
 - Electronic Music Technology
 - Basic Electronics
 - Automotive Servicing

For career courses approved under GI Bill
 check for details.

- Computer Programming
- Programming in C++ with Windows
- Desktop Publishing
- Word Processing Home Business
- Home Inspection
- Building Construction
- Bookkeeping & Accounting

Name _____ (please print) Age _____

Address _____

City/State/Zip _____ Accredited Member, National Home Study Council 3-0193

NEW LIT

Use The Free Information Card for fast response.

McGraw-Hill Encyclopedia of Science & Technology, Seventh Edition; edited by Sybil P. Parker. Mc-Graw Hill, Inc., Professional Book Group, 11 West 19th Street, New York, NY 10011; Phone: 1-800-2-MCGRAW; \$1900.

In 20 volumes (13,450 pages), this encyclopedia set covers 81 major subject areas, ranging from acoustics to virology, from mathematics to paleontology, from electricity and electromagnetism to zoology. Maintaining the encyclopedia's tradition of accuracy, clarity, objectivity, thoroughness, and rigorous scholarship, an international advisory board and 75 consulting editors put together the work of 3,000 distinguished experts, including 21 Nobel Prize winners for this edition.

The Seventh Edition has been substantially revised and updated. It reports on the latest research in each of the fields it covers, and also examines the theories and perspectives that have emerged in the five years since the release of the Sixth Edition. Material on

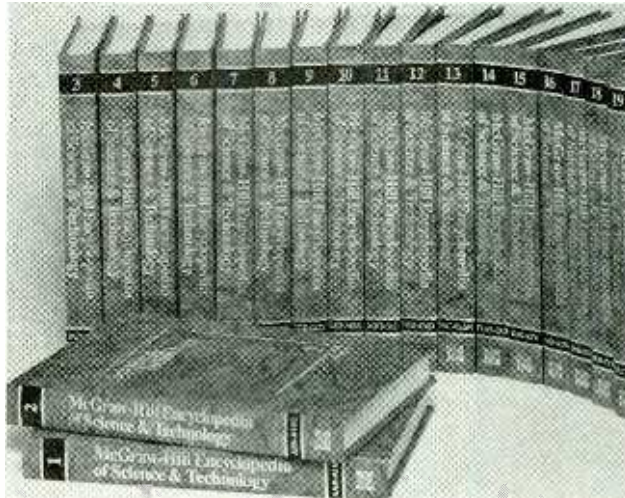

CIRCLE 40 ON FREE INFORMATION CARD

entire disciplines—including medicine, physics, chemistry, electronics, computers, telecommunications, and the earth sciences—has been revamped to reflect the trends and advances of the last five years. A wide range of subjects is covered in new articles. Those topics include adhesive bonding, climate modeling, laser cooling, foot disorders, superstring theory, and oxygen toxicity. Others are psychomatic disorders, quasicrystals, Kepler's laws, sonochemistry, and

flexible manufacturing.

More than 13,000 drawings, maps, charts, diagrams and photographs—1960 of which are new to this edition—accompany the authoritative text. The encyclopedia features 15 pages of full-color photographs. Measurements are given in both the U.S. Customary System and the International System. The thorough index consists of both a 160,000-entry analytical index and a topical index that groups all the article titles into the 81 major subject areas.

SPECIALTY CHEMICALS CATALOG. Chemtronics, Inc., P.O. Box 1448, Norcross, GA 30091-9931; free.

This 44-page, full-color catalog features a full line of specialty chemicals and products for the electronics industry. Written to help readers quickly and easily identify the right products for their applications, the catalog uses color-coded icons to clearly identify product categories such as precision cleaning agents, circuit refrigerants, and desoldering braid. Helpful product application tips are also designated by icons. Detailed

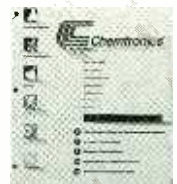

CIRCLE 38 ON FREE INFORMATION CARD

application, Mil-Spec, and compatibility charts are included. In addition to specifying product features and benefits, the catalog provides complete packaging information. Environmental impact data is provided to help users better understand the potential impact the chemicals might have on the environment. A detailed chart lists each product's content of chlorofluorocarbons (CFC's), hydrofluorocarbons (HFC's), hydrochlorofluorocarbons (HCFC's), chlorinated solvents, and volatile organic compounds, as well as the product's ozone depletion potential.

TEST INSTRUMENTS CATALOG (BK-93). B + K Precision, Division of Maxtec International Corp., 6470 West Cortland Street, Chicago, IL 60635; Phone: 312-889-1448; Fax: 312-794-9740; free.

B + K's line of electronic test instruments, including oscilloscopes, IC testers, spectrum analyzers, digital multimeters, video test instruments, probes, and ac-



CIRCLE 39 ON FREE INFORMATION CARD

cessories, is covered in this 64-page catalog. It provides complete specifica-

tions in detailed listings and easy-to-use comparison charts. Key product features and selected product applications are summarized. The catalog also describes a complete line of instrument accessories. A glossary of terms for each major product category is included in the catalog to help users identify the right instrument for a given task.

BUYING A PERSONAL COMPUTER. PC Health Center, 668 Main Street, Suite 130, Wilmington, MA 01887; Phone: 508-988-9095; \$19.95 (dealer discounts available).

This instructional videotape uses down-to-earth language and illustrations combined with animated graphics to help consumers get over the fear and confusion in buying a computer. The 50-minute tape introduces viewers to the major uses of personal computers, and describes hardware options, covering motherboards, monitors, floppy- and hard-disk drives, case arrangements, keyboards, modems, mice,

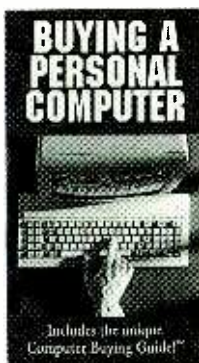

CIRCLE 37 ON FREE INFORMATION CARD

printers, and more. The videotape also includes a computer buying guide with "create-your-own-system" charts. The charts help viewers map out what they need in a computer before they head to the computer store. A unique feature of the video is that it can be personalized with the name of a retailer or manufacturer to create lasting name association in the viewer's mind. It also includes a chart that can recommend specific computer models for common applications, and a discount coupon for use toward one of a sponsoring company's computer systems.



GET YOUR RECHARGE CATALOG FREE...EARN BIG \$\$ IN YOUR SPARE TIME—All supplies and Do-It-Yourself kits with complete instructions available. Supplies cost from \$9.95 in qty and you can sell recharged toner cartridges for \$40.00 to \$55.00 each. Printers include HP LaserJet and Series II, Apple LaserWriter, QMS, etc. Canon PC-25 Copier also. **CHENESKO PRODUCTS, 2221 Fifth Ave., Suite #4, Ronkonkoma, NY 11779, 516-467-3205. FAX 516-467-3223, 1-800-221-3516**

CIRCLE 178 ON FREE INFORMATION CARD



250 MHz SUPERIOR Scope Probe. TPI's new SUPERIOR probe outperforms all comparably priced competitors. It features 1.4nSec risetime and low capacitance for minimal circuit loading. Measuring tip and ground lead are replaceable. Cable life is extended by strain relief at both ends. Works with all 1Mohm oscilloscopes. Model SP250 \$54. Call for free catalog 1-800-368-5719. **TEST PROBES INC. San Diego, CA 92121**

CIRCLE 123 ON FREE INFORMATION CARD

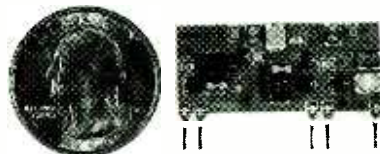
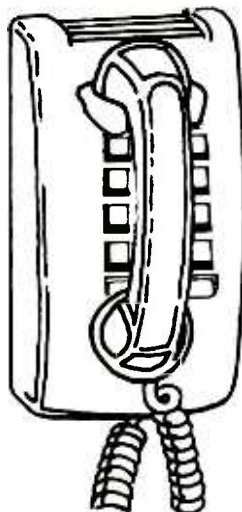

TWO TRANSMITTERS IN ONE! 5 MINUTE ASSEMBLY! MONEYBACK GUARANTEE! New Law Enforcement grade device on a single chip is the most sensitive, powerful, stable room transmitter you can buy. Uses any 3V-12V battery. Or attach to telephone line to monitor all telephone conversations over 1 mile away without batteries! 100mW output! 80-130MHZ. Receive on any FM radio or wideband scanner. VT-75 microtransmitter. \$49.95 + 1.50 S&H. VISA, MC, MO. COD's add \$4.00. **DECO INDUSTRIES, Box 607, Bedford Hills, NY 10507. 914-232-3878.**

CIRCLE 127 ON FREE INFORMATION CARD

CALL NOW AND RESERVE YOUR SPACE

- 6 x rate \$940.00 per each insertion.
- Fast reader service cycle.
- Short lead time for the placement of ads.
- We typeset and layout the ad at no additional charge.

Call 516-293-3000 to reserve space. Ask for Arline Fishman. Limited number of pages available. Mail materials to: mini-ADS, ELECTRONICS NOW, 500-B Bi-County Blvd., Farmingdale, NY 11735.

FAX: 516-293-3115



CABLE TV 50dB NOTCH FILTERS for interference removal or channel censoring. Filters are user-adjustable to desired channel # or frequency. Eight Models available, each for certain channels: 2 & 3; 4 to 6; 7 to 13; 14 to 17; 18 to 22; 23 to 29; 30 to 36; 95 to 99 plus 0 & 1. Just \$30 each or 3 for \$75, includes shipping. ONE MONTH MONEY BACK, fast delivery. Visa, MC, check or M.O. (C.O.D. is \$5 extra) Huge discounts for higher quantities. **STAR CIRCUITS, P.O. Box 94917, Las Vegas, NV 89193. Call 24 hours 1-800-535-7827.**

1992-93 TECHNICAL GUIDE AND CROSS REFERENCE, SIXTH EDITION. NTE Electronics, Inc., 44 Farrand Street, Bloomfield, NJ 07003; 1-800-631-1250 (in NJ, 201-748-5089); Fax: 201-748-6224; \$4.95 (in Canada, \$8.50 in U.S. dollars).

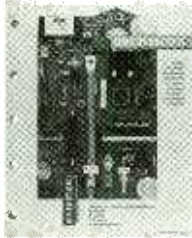

CIRCLE 36 ON FREE INFORMATION CARD

More than 3500 NTE semiconductors are cross-referenced with over 250,000 U.S., Japanese, and European part numbers. The catalog features a new, easier-to-read, thumb-through format. It in-

cludes technical information, device replacement considerations and device mounting techniques. The catalog covers semiconductors, capacitors, and flame-proof resistors for industrial, consumer, and commercial applications.

THE GREAT COMMUNICATORS: AUDIBLE SIGNAL DEVICES AND SPEAKERS. International Components Corporation, 105 Maxess Road, Melville, NY 11747; Phone: 516-293-1500; free.

This 10-page catalog describes the Intervox lines of buzzers, transducers, piezoelectric devices, and speakers. The products have applications in alarms, warning devices, and monitors in home, commercial, and industrial equipment. Detailed specifications are presented for



CIRCLE 35 ON FREE INFORMATION CARD

electronic buzzers, electro-acoustic transducers, piezoelectric devices, alarms, melody buzzers, telephone ringers, dynamic receivers, headphone drivers, and AC buzzers. A separate section covers miniature and subminiature speakers.

THE RADIO AMATEUR'S DIGITAL COMMUNICATIONS HANDBOOK; by Jonathan L. Mayo, KR3T. TAB Books, Division of McGraw-Hill Inc., Blue Ridge Summit, PA 17294-0850; Phone: 1-800-822-8138; \$14.95.

Allowing both beginner and experienced packet-radio enthusiasts to take advantage of state-of-the-art digital communications technology, this book contains all the information needed to stay on top of the latest developments in digital radio communications and to unlock the full potential of their stations.

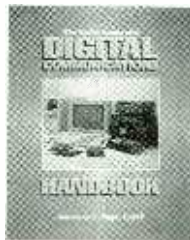

CIRCLE 34 ON FREE INFORMATION CARD

The illustrated, one-stop source of detailed information covers such topics as CW, ASCII RTTY, FSTV, SSTV, Baudot RTTY, AMTOR, packet, and fax. Besides providing a brief developmental history of packet radio, the book ex-

amines packet protocols and procedures. It also explains how to set up a digital communications station, and it describes the equipment and accessories needed to furnish it. In addition, extensive appendices cover everything from code charts to operating frequencies.

CHOOSING DACs FOR DIRECT DIGITAL SYNTHESIS; by David Buchanan. Analog Devices Literature Center, 70 Shawmut Road, Canton, MA 02021; Fax: 617-821-4273; free.

This 12-page application note explains the advantages of direct digital synthesis (DDS). A technique for producing very fast,



CIRCLE 33 ON FREE INFORMATION CARD

phase-continuous frequencies with high accuracy, DDS offers wideband tuning and temperature and time stability. The digital-to-analog converter is a critical element of a DDS system, and the note details how to select the most appropriate DAC for your design. Applications for DDS include frequency synthesis, military systems, and telecommunications. The note also discusses DDS background, performance characteristics, technology, and advantages and disadvantages. It is illustrated with graphs and charts that display ideal testing outcomes, frequency comparisons, and other helpful information regarding DAC's for use in DDS systems.

R-E

QUALITY TV & VCR PARTS

SEMICONDUCTORS

	2SCD1341P	STK0080	\$16.95ea
	2SD869	10/up STK4273	\$9.95ea (10 min)
	2SD1398	\$1.99ea STR30120	\$3.95ea
	2SD1426		

REPLACEMENT FLYBACKS

154-074E	GOLDSTAR	\$19.95ea	
154-040A	GOLDSTAR	\$19.95ea	
FCC1415AL	SMASUNG	\$19.95ea	
3214003	EMERSON	\$24.50ea	
TLF14423F	PANASONIC	\$29.95ea	
TLF14530F	PANASONIC	\$29.95ea	
2434391	HITACHI	\$34.95ea	

IDLERS & GEARS

164113	RCA	\$3.50ea	(10 min)
433-015A	GOLDSTAR	\$2.50ea	
NPLY0006GEZZ	REPLACEMENT	\$2.95ea	
143-0-4204-00400	FISHER ORIG.	\$4.95ea	

POPULAR PARTS

526A	TRIPLER	\$10.95ea	
4-1164-031600	SANYO RF MODULATOR	\$14.95ea	
100M/50V	RADIAL	20/for \$10.00	
4.7M/250V	RADIAL	10/for \$ 5.50	
1000M/200V	SNAP-IN	5/for \$12.50	
47M/50V	RADIAL	10/for \$ 4.50	



FREE 56 PAGE CATALOG

CALL TOLLFREE
1-800-628-1118
FAX# 1-800-628-1005



MAI ELECTRONICS
975 JAYMOR ROAD
SOUTHAMPTON, PA 18966

CIRCLE 89 ON FREE INFORMATION CARD

Enter A World Of Excitement with a Subscription to

Popular Electronics®

Get the latest electronic technology and information monthly!

Now you can subscribe to the magazine that plugs you into the exciting world of electronics. With every issue of Popular Electronics you'll find a wide variety of electronics projects you can build and enjoy.

Popular Electronics brings you informative new product and literature listings, feature articles on test equipment and tools—all designed to keep you tuned in to the latest developments in electronics. So if you love to build fascinating electronics, just fill out the subscription form below to subscribe to Popular Electronics... It's a power-house of fun for the electronics enthusiast.

EXCITING MONTHLY FEATURES LIKE:

- CONSTRUCTION**—Building projects from crystal sets to electronic roulette
- FEATURES**—Educational training on digital electronics, Ohm's Law, Antennas, Communications, Antique Radio, Simplified Theory
- HANDS-ON-REPORTS**—User test comments on new and unusual consumer products
- SPECIAL COLUMNS**—Think Tank, Circuit Circus, Computer Bits, DX Listening, Antique Radio, Amateur, Scanner Scene

PLUS: ALL OUR GREAT DEPARTMENTS!

You'll get 12 exciting and informative issues of Popular Electronics for only \$18.95. That's a savings of \$23.05 off the regular single copy price. Subscribe to Popular Electronics today! Just fill out the subscription order form below.

FOR FASTER SERVICE CALL TODAY

1-800-827-0383

(7:30AM-8:30PM)

EASTERN STANDARD TIME

Popular Electronics® SUBSCRIPTION ORDER FORM

AREA 3

P.O. Box 338, Mt. Morris IL. 61054

YES! I want to subscribe to Popular Electronics for 1 Full year (12 Issues) for only \$18.95. That's a savings of \$23.05 off the newsstand price.

(Basic Subscription Rate—1 yr/\$21.95)

Payment Enclosed Bill me later

Please charge my: Visa Mastercard

Acct. #

Signature _____

Exp. Date _____

PLEASE PRINT BELOW:

NAME _____

ADDRESS _____

CITY _____

STATE _____

ZIP _____

Allow 6 to 8 weeks for delivery of first issue. U.S. Funds only.

In Canada add \$6.68 Postage (Includes G.S.T.) All Other Foreign add \$7.50 Postage

THE PARTS PLACE SM

NEW! Autoranging LCD Digital Multimeter

Convenient autoranging and auto-polarity at a low price. Select the function—meter does the rest. Diode-check mode. Measures to 1000VDC, 750VAC, 200mA DC current, 20 megohms resistance. Fuse protected, UL 1244 listed. #22-166 36.99



TECHLINE™ Tools—The new standard in strength and precision!



- Precision-crafted with top-quality materials
- Designed for long life and ease of use
- Backed by Radio Shack's 1-Year Limited Warranty

New TECHLINE tools represent Radio Shack's uncompromising dedication to quality. Each is precision-crafted of long-lasting, hard-working materials and employs the latest design innovations for comfort and ease of use. And, each is backed by our full 1-year limited warranty.

Speedy service and low prices on thousands of parts and accessories!



- FREE delivery to Radio Shack on orders \$5 and up
- Semiconductors and ICs ■ Hard-to-find batteries
- CB and scanner crystals ■ Long-life vacuum tubes
- Phono cartridges/styli ■ SAMS® service books

Why pay more for mail-order? Your Radio Shack stocks 1000 electronic components, and another 15,000 are available fast from our special-order warehouse. Ordering is easy! Bring in the exact part number (or old part). We'll check availability and order by phone. Delivery time to your nearby Radio Shack for most items is a week.



TECHLINE Rechargeable Soldering Gun. Great for autos, boats and campers—solder up to 250 joints on one charge. Trigger lock, light. UL listed AC charger, case. #64-2194 39.95

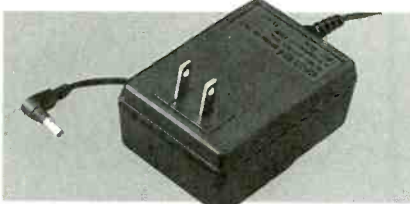

CD Player AC-to-DC Voltage Adapter. Saves batteries! Connect to your portable CD player's DC jack and plug into wall outlet to play from 120VAC. 3VDC regulated output. UL listed. #273-1659 16.95



AC Voltage Sensor. Detects broken connections, blown fuses, defective grounds, open breakers, more. Indicates presence of AC voltages from 70 to 440VAC. Replaceable battery. #22-103 11.99



TECHLINE 18-Piece Hex Key Set. Ideal for engine and machinery work. Heavy-duty steel alloy. Standard sizes. #64-1816 4.99



IR Transmitter Project Case. For beeper or remote. 9V battery compartment. Molded 7/8 x 2 3/8 x 4 1/4" enclosure. #270-294 4.49

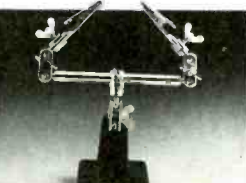

Project Holder. Alligator-type clamps adjust to hold work in any position. Solid cast-iron base prevents tipping. #64-2093 8.49

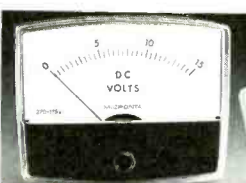

DC Voltmeter. Measure vehicle or power-supply voltage. Jeweled movement. Mounts in 1 7/8" diameter round hole. #270-1754 7.95



Infrared Sensor Card. Detects normally invisible infrared to confirm output from remotes, IR LEDs or lasers. #276-099 5.95

Radio Shack® SINCE 1921

AMERICA'S TECHNOLOGY STORE™

CIRCLE 78 ON FREE INFORMATION CARD

HAVE YOU LISTENED TO WORLD band (shortwave) broadcasts and found that you enjoyed them but were disappointed because your receiver was unable to hold onto the station you wanted? Perhaps only a few minutes passed before the station faded or was swamped out by another one. If you've now become a fan of world-band radio but would like better quality reception, the SWX6 receiver is the project for you to build.

Many inexpensive world-band shortwave receivers promise a lot, but they rarely deliver. New shortwave listeners are never sure whether the problem lies in the antenna, circuitry, or if the time of day had an effect on listening conditions. Many of the inexpensive receivers suffer from poor channel selectivity, poor image frequency rejection, and drift—weaknesses that make listening a strain.

Those problems are not present in up-scale receivers like the SWX6 receiver. The SWX6 delivers performance that matches many of the high-priced rigs, but it can be built for less than \$100 worth of parts with the plans in this article. Because digital frequency synthesis is not used in the SWX6, it's a good project to build if you want to learn (or get a refresher course) in the basics radio-frequency circuitry.

Leading features

Figure 1 is a simplified block diagram of the receiver. The incoming radio frequency (RF) is filtered by the bandpass filter and mixed with the output of the crystal oscillator in the first mixer. After passing through the 16.45 to 17.1 MHz filter and being amplified by the first intermediate-frequency (IF) amplifier, the signal is mixed with the output of the variable frequency oscillator (VFO) in the second mixer.

The signal is then passed through the 9.83-MHz crystal filter before being fed to the second IF amplifier, which is under the control of the AGC circuit. The detector converts the RF signal to audio and the audio

WORLD BAND RADIO RECEIVER

JOHN PIVNICHNY, N2DCH

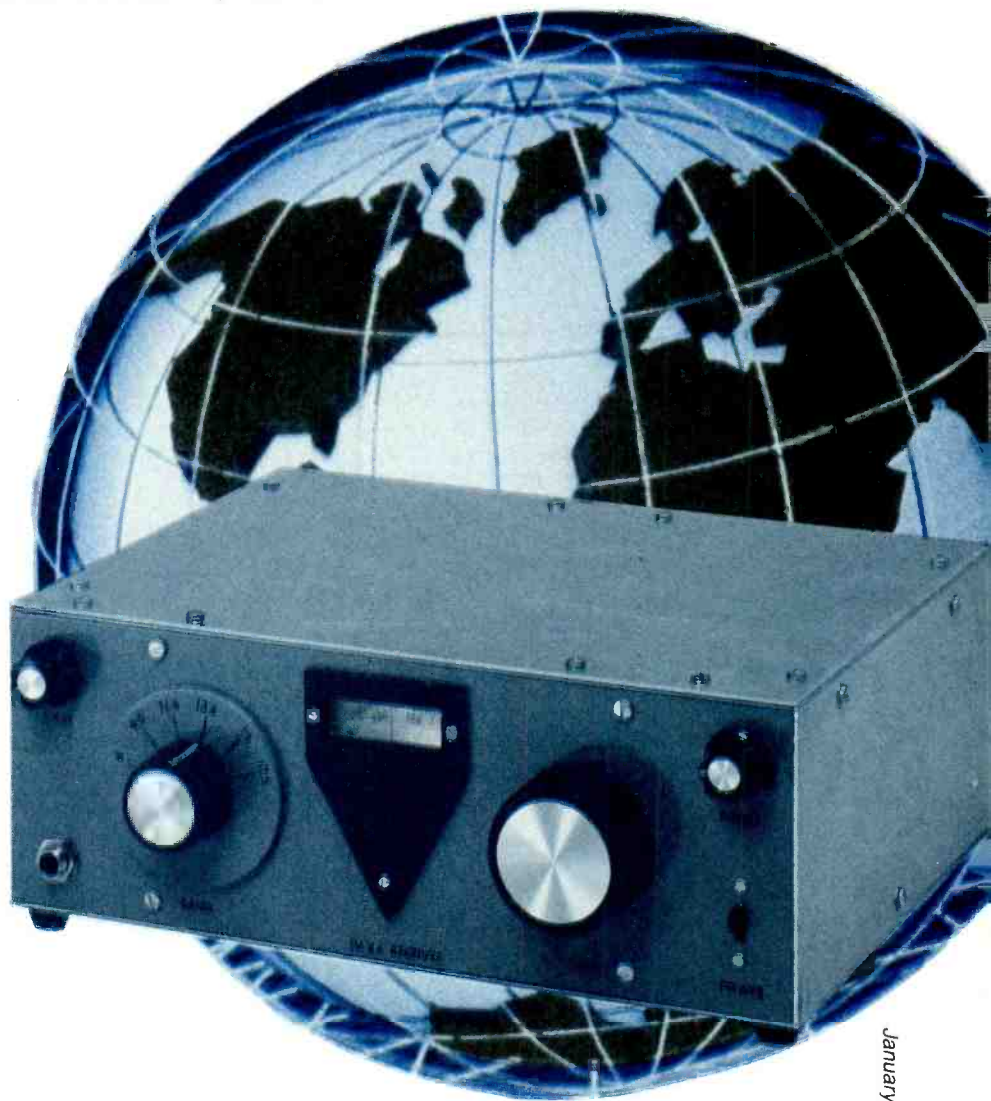

***Build this world band receiver
and enjoy performance that is
superior to many store-bought models***

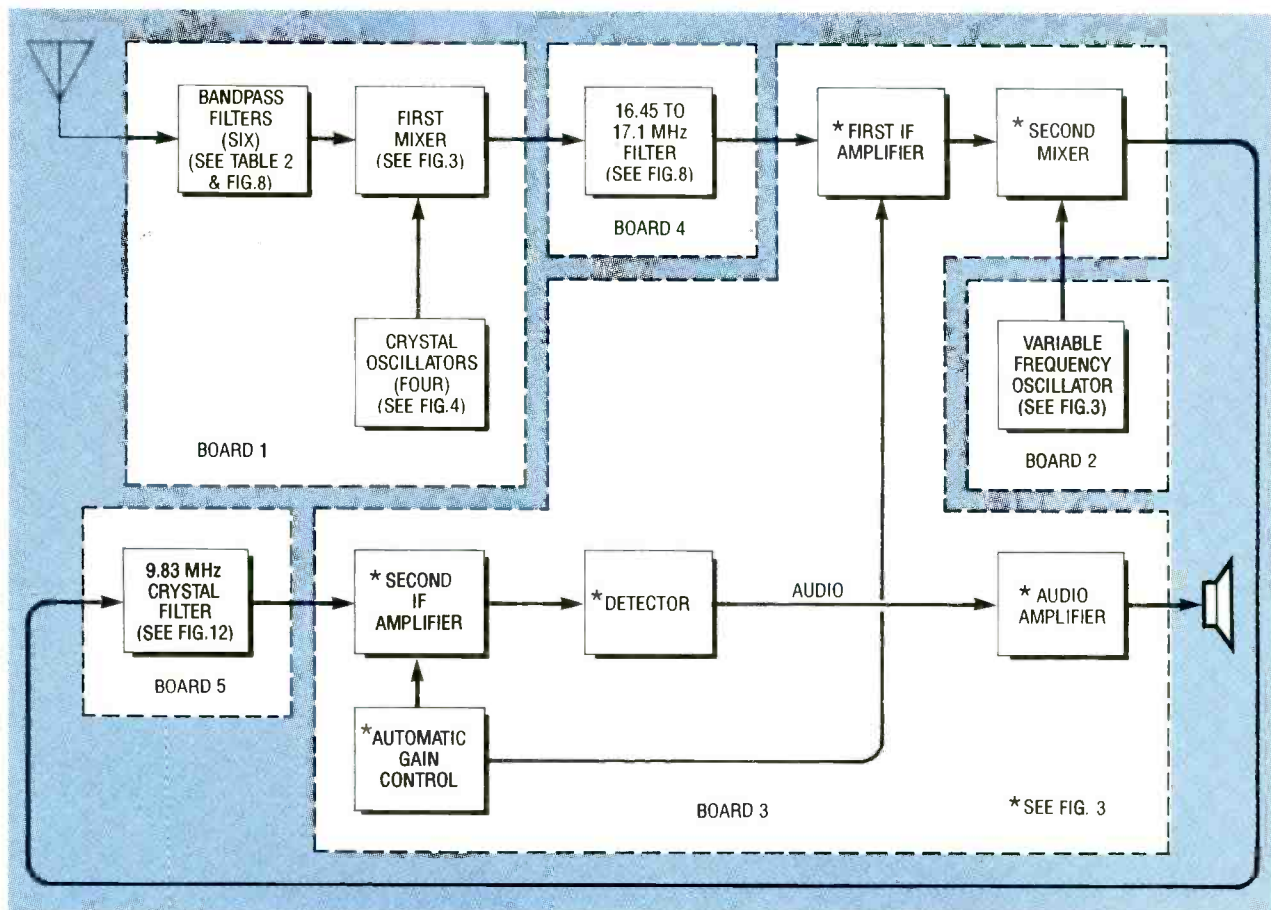

FIG. 1—FUNCTIONAL BLOCK DIAGRAM OF SWX6 RECEIVER showing the partitioning of circuits on three principal circuit boards.

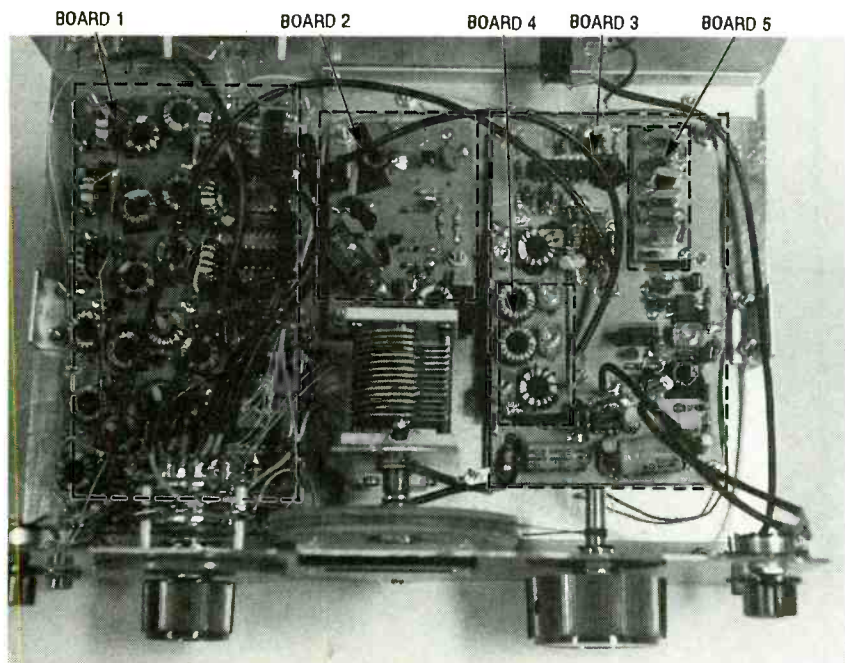

FIG. 2—VIEW OF THE INSIDE OF THE SWX6 RECEIVER showing the relative positions of the three principal and two piggy-back circuit boards.

amplifier amplifies it, giving the listener a choice of loudspeaker or headphones.

The received signal is kept essentially distortion-free by the six-pole crystal filter which pro-

vides good selectivity, bandpass filters which handle image rejection, and a very stable, low-drift analog tuning oscillator. This circuit is so stable, you will never have to readjust the dial once a station is tuned in!

The double-conversion circuitry provides ample IF gain. The fast-responding automatic gain circuit (AGC) reduces fading all the way down to an actual null. Separate bandpass filters for each of the six bands provide excellent rejection of out-of-band signals and signals at the image frequencies. As a result of all these features, this receiver is easy to operate and makes for pleasurable listening.

Figure 2 is a photograph of the inside of the prototype SWX-6 receiver showing the details of its modular construction. Conventional etched circuit boards are not used in building the SWX6. The circuitry is assembled on five blank copper-clad laminate circuit boards with the copper foil side facing up to serve as a common ground plane. Component leads

pass through holes drilled in the board for interconnection and soldering on the bare side. Copper foil is removed around all drilled holes by countersinking to provide adequate isolation from ground.

The SWX6 is organized to receive six bands: 6, 9.5, 11.5, 13.5, 15 and 17.5 MHz. These bands are marked on a plate behind the BAND knob. The diamond-shaped tuning bezel at the center of the panel is part of the tuning assembly that includes a moving dial behind the window and the TUNE knob to the right. There is a GAIN knob at the upper left, a speaker or headphone jack at the lower left,

an AUDIO knob at the upper right, and a POWER switch at the lower right. The audio amplifier can drive either a speaker or headphones with a resistance of 4 to 16 ohms.

First mixer and IF

Figure 3 is the complete schematic for the SWX6 receiver. The first mixer converts each of the popular shortwave bands to the 16.45 to 17.1 MHz range. The heart of this stage is IC1, an MC1496 balanced modulator/demodulator. A double-balanced mixer with separate bandpass filters for each band provides excellent performance.

A separate crystal oscillator/

divider is included for each band, permitting the use of inexpensive, readily available, microprocessor-timebase crystals for excellent stability. Also, separate oscillators are easier to build than a synthesizer, and they give better wideband noise performance. The schematics for these crystal oscillators are shown in Fig. 4.

For example, on band 1, to tune 5.95 to 6.6 MHz, the local oscillator must apply a 10.5 MHz signal to convert this range to 16.45 to 17.1 MHz. For this band see Fig. 4-a. The oscillator-tripler circuit has a 7 MHz crystal (XTAL7). It is followed by a divide-by-two inte-

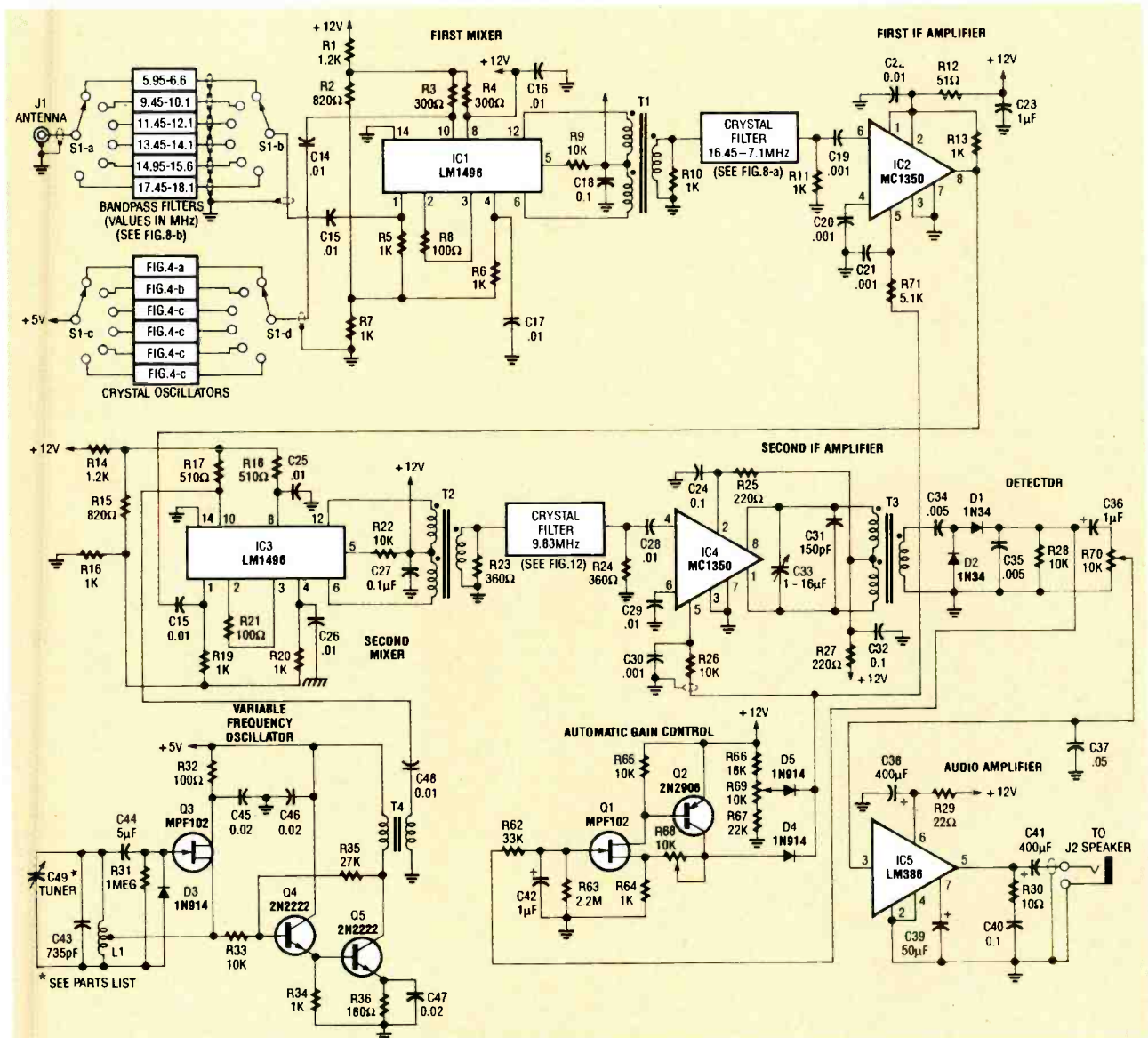

FIG. 3—SCHEMATIC FOR THE SWX6 RECEIVER with the principal functional circuits labeled. Make all connections between the contacts of switch S1-a and the bandpass filters with enameled magnet wire.

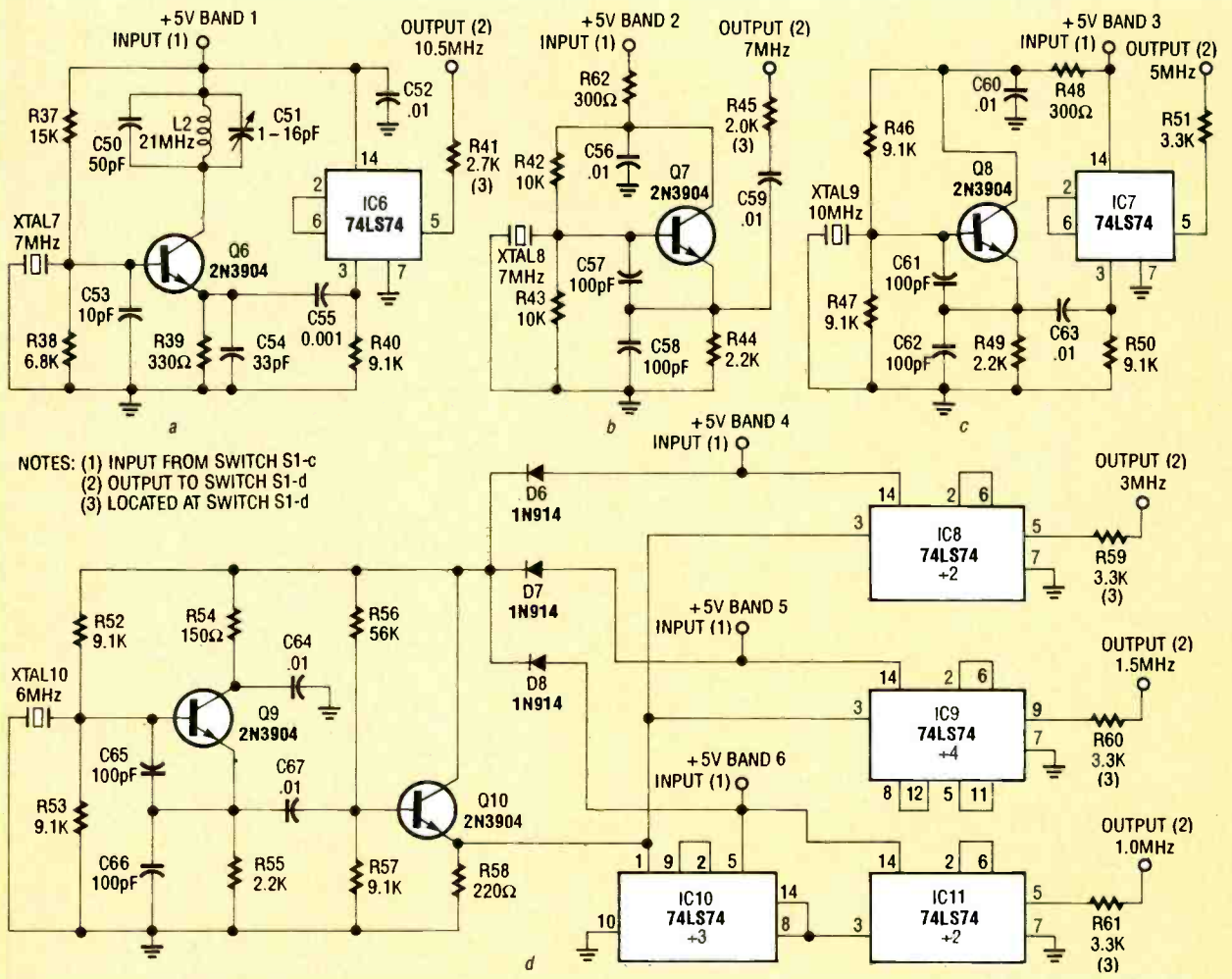

FIG. 4—SCHEMATICS FOR THE CRYSTAL-CONTROLLED oscillators that tune the six bands of the receiver.

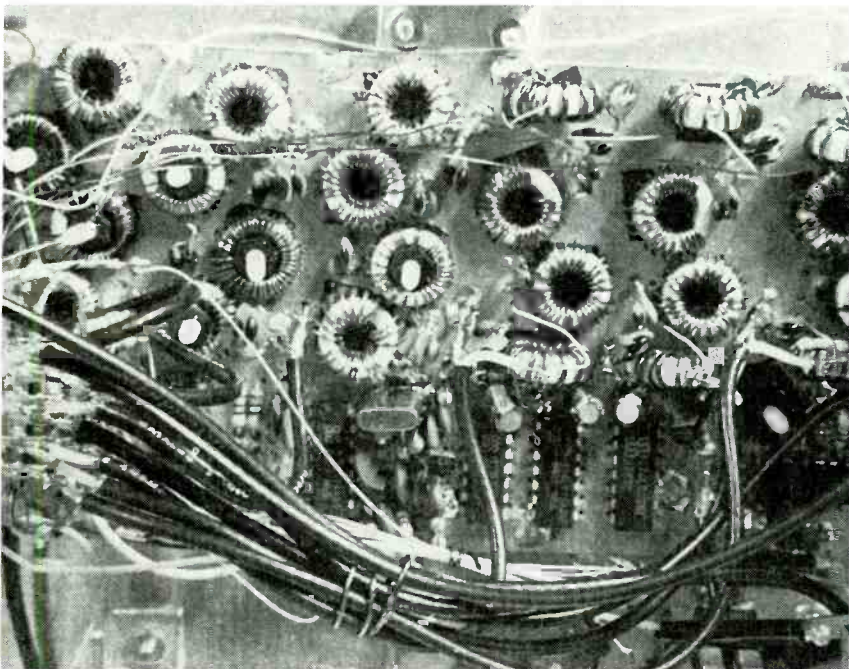

FIG. 5—FILTER/MIXER BOARD layout with coaxial cabling and other wiring to the band switch shown in foreground

grated circuit, IC6, a 74LS74. (A low-cost 10.5-MHz micro-processor-timebase crystal was not available.) Frequencies for the other bands are shown in the digrams 4-b through 4-d.

As shown in Fig. 3, the MC1350 monolithic IF amplifiers IC2 and IC4 amplify in both the first and second IF amplifier stages. The first MC1350, IC2, follows the first mixer stage and 16.45 to 17.1 MHz band-pass filter. This wideband amplifier increases the level of all signals within this 650-kHz range. Note that the gain input pins, Pin 5, of each IF amplifier are fed by the output of the AGC section. However, the first IF amplifier is fed with 5.1K resistor, R71, while the second IF amplifier is fed with 10K resistor, R26.

This difference ensures that there is more gain reduction of strong signals in the first ampli-

TABLE 1
DIMENSIONS FOR CIRCUIT BOARDS AND ENCLOSURE PANELS

Function	Length (in.)	Width (in.)
Circuit boards 1		
1. First mixer bandpass filters, oscillators	6	3 1/4
2. Variable frequency oscillator	3	2
3. General circuitry	5	3
4. 16.45 to 17.1 MHz filter	3	1
5. 9.83 MHz crystal filter	2 3/8	1
Enclosure panels 2		
1. Top and bottom	10	7
2. Front and back	9.9	3.5
3. Two sides 3	7	3.5

Notes 1: Blank single-sided copper-foil laminate
2: 0.060-inch thick sheet aluminum
3: Allow for inseting the side panels

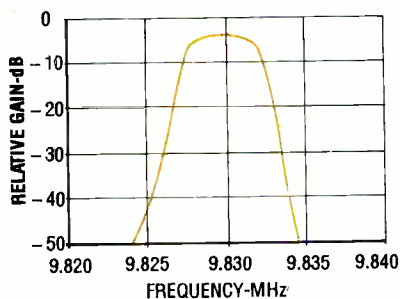

FIG. 6—CRYSTAL FILTER RESPONSE curve showing relative gain in decibels vs. frequency in kilohertz.

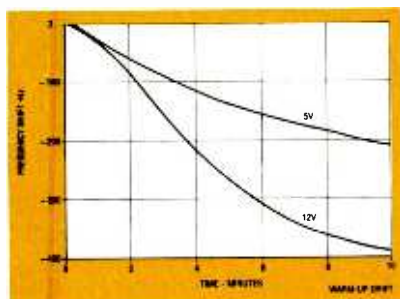

FIG. 7—CURVE SHOWING DRIFT IN FREQUENCY of tuning oscillator during 10-minute warmup period.

nals and ensures that any signal outside the desired band is sharply reduced prior to mixing at the first oscillator. Further rejection occurs in the first IF bandpass filter prior to any amplification. Only signals in the selected band get through.

The separate bandpass filters for each of the bands are built on board 1, the largest of the five circuit boards in the receiver (see Fig. 1) shown in Fig. 5. This filter-mixer board measures 3 1/4 × 6-inches and it contains the oscillator/divider circuits for each band and the first mixer circuit. (Schematic diagrams for the bandpass filters are included along with a table of component values for the six bands later in this text.)

The tuning oscillator and isolation amplifier are built on board 2, a 2 × 3-inch board, and the general circuitry is built on board 3, a 3 × 5 inch-board. The two smaller boards (4 and 5) with coils and crystal holders are mounted piggy-back on board 3.

The three principal circuit boards are mounted on the aluminum baseplate for the enclosure. The front, back, top and side panels are also cut from the same sheet aluminum and joined with aluminum angle stock, nuts and bolts.

The crystal filter response curve showing relative gain in decibels vs. frequency in megahertz is shown in Fig. 6. This curve helps to explain why sta-

tions can be received so clearly as you tune across them. There is essentially no adjacent-channel feed-through. Stations are received loud and clear, limited only by propagation strength, not by the wide limits of a ceramic IF filter like those found in inexpensive receivers.

Construction procedure

The first step in the construction of the SWX6 receiver is to cut the five circuit boards to size. These are cut from copper-clad laminate circuit board stock in accordance with Table 1. Carefully drill 0.060-inch holes in the four corners of the three largest boards for later mounting to the chassis baseplate with screws and nuts stacked for use as standoffs. Set the boards aside for later parts-placement planning and lead-hole drilling.

It is also advisable to cut (or have cut) the enclosure panels from the 0.050-inch thick sheet aluminum stock to the sizes specified in Table 1. Drill or form a 1 1/2 × 1/2-inch dial window in the front panel on the center line 1/2-inch down from the top.

Plan the location of all panel-mounted components (e.g., rotary BAND SWITCH, GAIN and AUDIO potentiometers, TUNE dial) in the front panel and drill or form their mounting holes. Drill or form the holes for mounting the antenna jack in the back panel.

Cut the 1/2-inch aluminum angle stock to size, and drill all the holes in all the panels and angle stock necessary to bolt the panels together to form a secure enclosure. Assemble it after you have completed mounting all of the panel-mounted components and circuit boards, and completed all board-to-board and board-to-panel component wiring.

You might want to complete the tuner assembly before building the circuitry. Holes must be drilled in the baseplate to mount the tuning capacitor and in the front panel to mount the bezel and the dial window on opposing sides of the cutout in the front panel. A complete section covering this part of the

fier, thus preventing possible overloading of the input of the second IF amplifier. Gain reduction will occur whether it is due to the manual GAIN control R69 on the front panel, or automatically due to AGC response on reception of strong signals or those that fade in and out.

One filter per band

A separate bandpass filter for each band removes image sig-

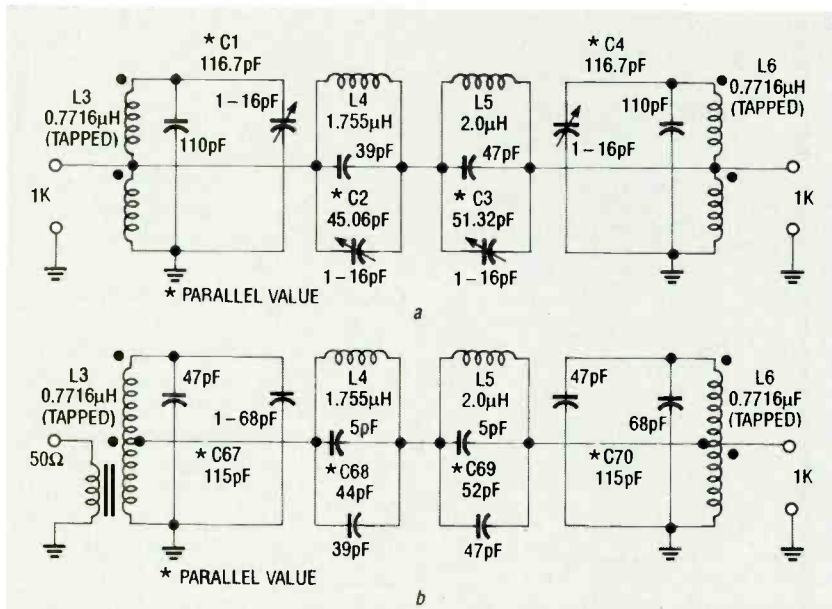

FIG. 8—SCHEMATICS FOR THE BANDPASS FILTER for the 16.45 TO 17.1 MHz band, a, and the five other bands, b.

project is given further on in the text. You might also want to finish painting some of the alu-

minum enclosure panels before mounting any of the components on them.

Electronic circuitry

It is recommended that the receiver be built as a series of modules that are individually completed and tested before final assembly and wiring. None of the circuits in this receiver is particularly challenging, and construction should be well within the skill level of the amateur who works with care and attention to detail.

Printed circuit boards were not used to build the SWX6 receiver circuitry so it will be necessary for you to plan the locations of all components on the boards before doing any assembly and soldering. After establishing a component layout pattern, drill all of the holes necessary to insert the leads of the components through the boards.

The components are mounted on the copper-clad surface of the board by drilling 0.040-inch holes at the proper

Parts List

All resistors are 1/4-watt, 5% unless otherwise specified.

R1, R14—1200 ohms
 R2, R15—820 ohms
 R3, R4, R48—300 ohms
 R5, R6, R10, R11, R13, R16, R19, R20, R34, R64—1000 ohms
 R8, R21, R32—100 ohms R9, R22, R26, R28, R33, R42, R43, R65—10,000 ohms
 R12—51 ohms
 R17, R18—510 ohms R23, R24—360 ohms R25, R27, R58—220 ohms
 R29—22 ohms
 R30—10 ohms R31—1 megohm
 R35—27,000 ohms
 R36—180 ohms
 R37—15,000 ohms
 R38—6,800 ohms
 R39—330 ohms
 R40, R46, R47, R50, R52, R53, R57—9100 ohms
 R41—2700 ohms
 R44, R49, R55—2200 ohms
 R45—2000 ohms
 R51, R59, R60, R61—3300 ohms
 R54—150 ohms
 R56—56,000 ohms
 R62—33,000 ohms
 R63—2.2 megohms
 R66—18,000 ohms
 R67—22,000 ohms
 R68—10,000 ohms, trimmer
 R69, R70—10,000 ohms, potentiometer, panel-mount
 R71—5100 ohms

Capacitors

C1, C4—116.7 pF (110 pF in parallel with

1—16 pF trimmer, Mouser 24PX016 or equivalent)
 C2—45.06 pF (39 pF in parallel with 1—16 pF trimmer, Mouser 24PX016 or equivalent)
 C3—51.32 pF (47 pF in parallel with 1—16 pF trimmer, Mouser 24PX016 or equivalent)
 C5, C7, C9, C11,—66pF (56pF in parallel with 10 pF)
 C6, C10—49.7 pF (47 pF in parallel with 2.7 pF)
 C8—68 pF
 C12, C13—180 pF
 C14, C15, C16, C17, C22, C24, C25, C26, C28, C29, C48, C52, C56, C59, C60, C63, C64, C67—0.01µF
 C18, C24, C27, C32, C40—0.1µF
 C19, C20, C21, C30, C55—0.001µF
 C23, C36, C42—1.0 µF, electrolytic
 C31—150 pF
 C33, C51—1—16 pF trimmer, Mouser 24PX016 or equivalent
 C34, C35—0.005µF
 C37—0.05µF
 C38, C41—400µF, electrolytic
 C39—50µF, electrolytic
 C43—735 pF (three 220 pF in parallel with 75 pF, silvered mica or NPO ceramic)
 C44—5 pF, ceramic NPO
 C45, C46, C47—0.02µF
 C49—10—140 UNIT air dielectric tuning, Fair Radio Sales No. C12/T784 or equivalent (surplus item)
 C50—50 pF
 C53—10 pF
 C54—33 pF
 C57, C58, C61, C62, C65, C66—100 pF

C67, C70—115 pF (47 pF in parallel with 68 pF)

C68—44 pF (39 pF in parallel with 5 pF)

C69—52 pF (47 pF in parallel with 5 pF)

Semiconductors

IC1, IC2—MC1496 balanced modulator/demodulator (Motorola) or equivalent
 IC3, IC4—MC1350 monolithic IF amplifier (Motorola) or equivalent

IC5—LM386 audio amplifier (National Semiconductor) or equivalent
 IC6, IC7, IC8, IC9, IC11—74LS74 Dual D flip-flop (Texas Instruments) or equivalent

IC10—74LS90 decade counter, (Motorola) or equivalent

Q1, Q3—MPF102 N-channel FET transistor

Q2—2N3906 PNP transistor

Q4, Q5—2N222 NPN transistor

Q6, Q7, Q8, Q9, Q10—2N3904 NPN transistor

D1, D2—1N34

D3, D4, D5, D6, D7, D8—1N914

Crystals

XTAL1, XTAL2, XTAL3, XTAL4, XTAL5,

XTAL6—9830.4 MHz

XTAL7, XTAL8—7.0 MHz

XTAL9—10.0 MHz

XTAL10—6.0 MHz

Switches

S1—four-pole, six-position rotary, Mouser 10WR046 or equivalent

S2—slide, panel-mounted, power

Transformers

T1, T2—16 turn 30 AWG trifilar on FT37-61 core, Amidon or equivalent

T3—10 turn, 26 AWG trifilar on T37-2 core, Amidon or equivalent

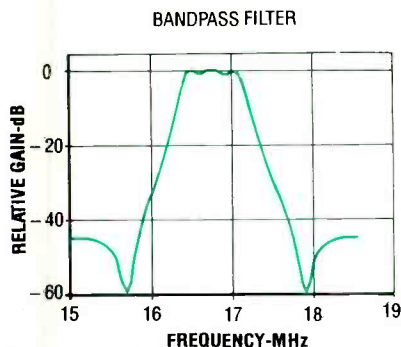

FIG. 9—CHARACTERISTIC CURVE FOR BANDPASS FILTER showing relative gain in decibels vs. frequency in megahertz.

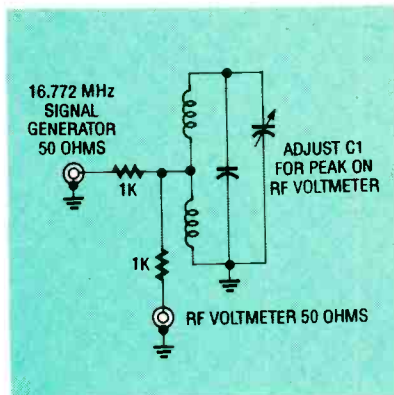

FIG. 10—TEST SETUP TO TEST THE END CAPACITOR.

TABLE 2—BANDPASS FILTER DATA

Band	Frequency (MHz)			No. turns on T-50-6 core				Tap turns
	f_c	f_{io}	f_{hi}	L1, L4	L2	L3		
1.	5.95 – 6.6	6.267	5.257	7.456	36	50	61	6
2.	9.45 – 10.1	9.770	8.738	10.924	23	34	38	3
3.	11.45 – 12.1	11.770	10.728	12.914	19	29	31	2
4.	13.45 – 14.1	13.771	12.723	14.907	16	24	27	2
5.	14.95 – 15.6	15.272	14.218	16.403	14	21	23	2
6.	17.45 – 18.1	17.772	16.714	18.897	12	19	20	1

Parts List

T4—primary 25 turns 26 AWG, secondary 5 turns 26 AWG on FT-37-43 core, Amidon or equivalent

Inductors

L1—12 turns 18 AWG on T-50-6 core (3 turns tapped from ground end), Amidon or equivalent

L2—18 turns, 26 AWG on T-30-10 core, Amidon or equivalent XXX

L3, L6—13 turns, 18 AWG on T-50-6 core (6 1/2 turns tapped from ground end) Amidon or equivalent

L4—21 turns, 22 AWG on T-50-6 core, Amidon or equivalent

L5—22 turns, 22 AWG on T-50-6 core, Amidon or equivalent

Connectors

J1—coaxial jack, SO239 or equivalent

J2—phone jack, mono

Miscellaneous:

28 T-50-6 powdered-iron toroid cores, Amidon or equivalent, six aluminum panels, 0.060-inch thick cut per Table 1, five copper-foil covered circuit boards cut per Table 1, four feet of RG-174/U coaxial cable, tuning capacitor mounting bracket (see text), 30 inches of 1/2 x 1/2-inch aluminum angle stock, reels of enameled magnet wire—18, 26, and 30 AWG, insulated hookup wire, 0.25-inch thick acrylic plastic, 4 x 4-inch for pulley (see text), 0.10-inch thick acrylic plastic for bezel, dial window, and rotary switch plate (see text), 30 inches of nylon cord, four knobs for front-panel manual controls, four rubber feet with self-tapping screws, No. 4-40 nuts bolts as required, solder

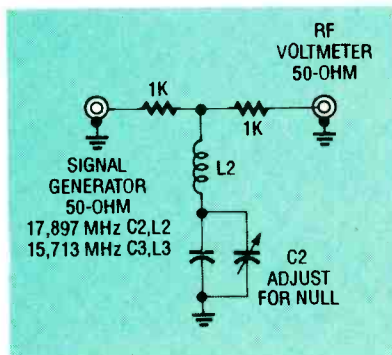

FIG. 11—TEST SETUP TO ADJUST CAPACITORS C2 and C3.

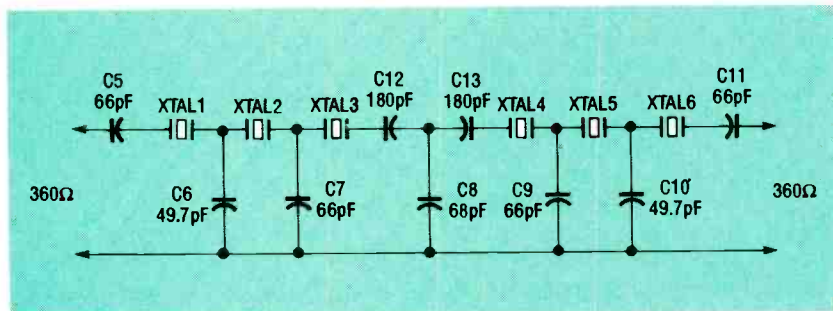

FIG. 12—SCHEMATIC FOR CRYSTAL FILTER showing the interconnection of 9830.4 kHz crystals and individual or parallel capacitors where needed to achieve desired values.

locations for all leads with a No. 60 drill. Countersink all holes with a 1/8-inch drill to remove the copper foil back to a radial distance of at least 0.050-inch

around the drilled holes to provide suitable isolation and insulation around the leads. It will be necessary to drill rows of holes for mounting the IC's.

Component interconnection is done on the back or bare side of the substrate with the wire from the component leads. In cases where the leads are of insufficient length to span the distances required, 30 AWG insulated hookup wire should be used.

Build the audio amplifier first, and then work back toward the antenna terminal: second IF amplifier and detector, automatic gain control, second mixer and so on until you get back to the first mixer.

To test the audio amplifier, put your finger on the input jack and listen for the AC hum with the headphones. For a more precise indication of its performance, feed in an audio signal and verify with an AC voltmeter that the gain is 40 with the volume control set full open.

Referring to Fig. 3, build the second IF amplifier and detector. The variable capacitor across the output transformer, C33, should be set by feeding a 9.83 MHz signal into the input of IC4 at pin 4. With a DC voltmeter on the detector to automatic gain control (AGC) line, tune for a peak.

Variable-frequency oscillator

Build the variable-frequency

oscillator (VFO) circuit on board 5, the 2 3/8 x 1-inch board listed in Table 1. The peak radio-frequency output voltage of the VFO amplifier measured at C48

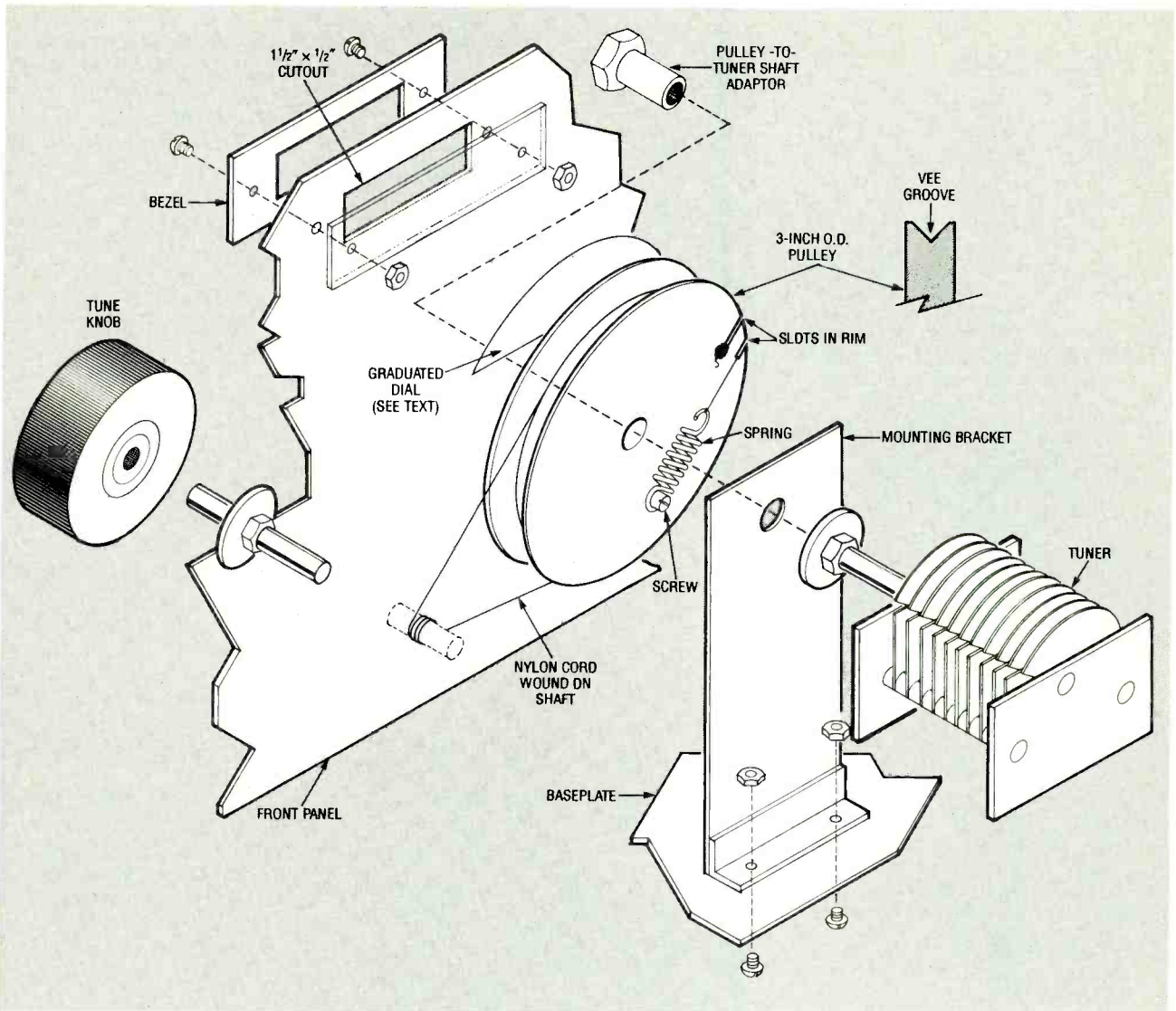

FIG. 13—EXPLODED VIEW OF DIAL DRIVE and tuning assembly with locking bearing.

should be 300 millivolts. Stability can be checked by monitoring the circuit with a frequency counter from a cold start. A typical drift curve for this circuit is shown in Fig. 7.

For optimum stability, the VFO should be powered by a 5-volt DC supply rather than the 12-volts used elsewhere in the receiver. A three-terminal 5-volt regulator on the output of the 12-volt supply can provide the 5-volts. The frequency of the VFO should be set to 6.670 MHz with the dial set at 0 by adjusting the turn spacing on L1. This can be checked later by listening for WWV at 10 MHz on band 2 (9.5) or 15 MHz (15) on band 5.

Bandpass filter

After the second mixer is com-

plete, you will have a tunable receiver covering the 16.45 to 17.1 MHz range. Now build and install the 16.45 to 17.1 MHz bandpass filter. Refer to the schematic, Fig. 8-a. Build this bandpass filter on board 4, a 1 × 3-inch piece of copper-clad, single-sided board stock so that it can be easily removed. See Table 1.

The crystals need not be matched if they are certified to be within the proper tolerance and purchased from a reliable vendor. Solder the crystals and disc capacitors in place, interconnect them, and mount the filter on the main circuit board with bare hookup wire.

To restrict the signals reaching the second mixer to the 16.45 to 17.1 MHz band, the

16.45 to 17.1 MHz crystal filter is placed ahead of the first IF amplifier. Figure 8-a is the schematic for this filter and Fig. 8-b is the schematic for the five other bandpass filters. All of the bandpass filters are wound on T-50-6 powdered-iron toroid cores, selected to have inductance Q's over 200. Ceramic capacitors are specified for use in the filters. Four variable capacitors are in parallel with fixed capacitors to form C1 through C4 in the 16.45 to 17.1 MHz bandpass filter to set those capacitance values precisely.

Figure 9 is a plot of the bandpass characteristic for the 16.45 to 17.1 MHz filter. The relatively steep skirts in this filter are produced by the two parallel resonant circuits (C2, L4 and C3, L5

Continued on page 68

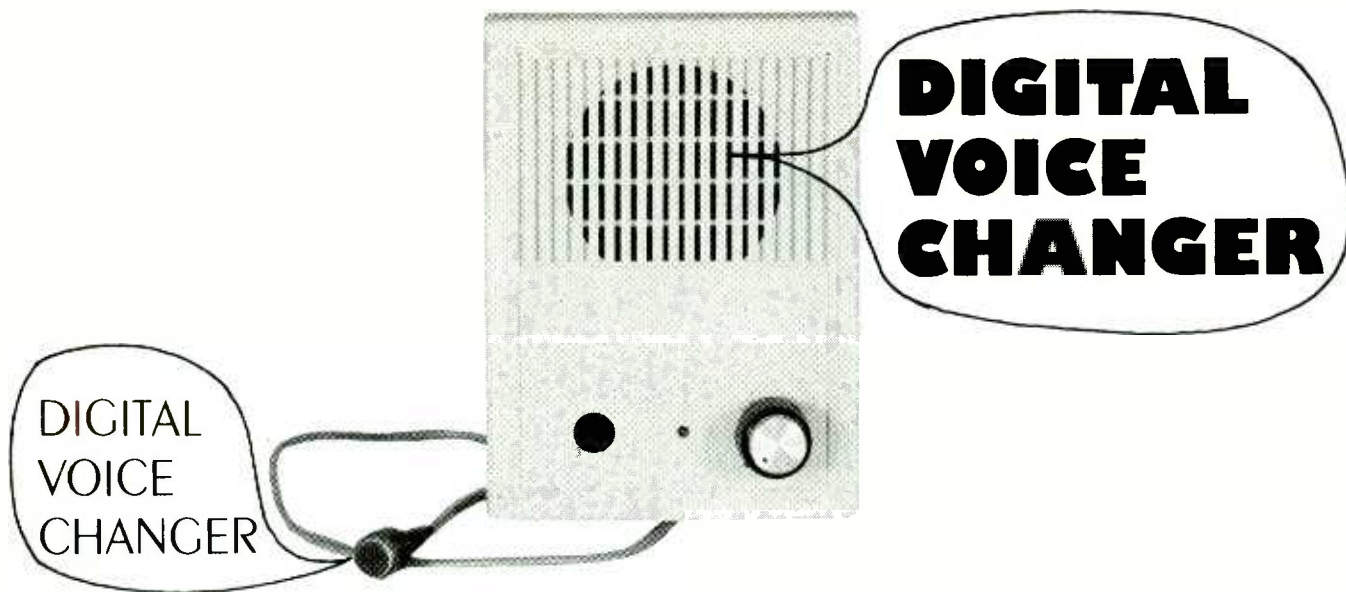

You can create unusual sound effects using some high technology with our voice changer.

DAVID WILLIAMS

HOW WOULD YOU LIKE TO BUILD A device that will change your voice in real-time and let you sound like a completely different person? This remarkable circuit can shift a person's voice one octave higher or one octave lower in 16 graduated steps. Just select the desired range and speak into the handheld microphone. You'll amaze your friends with the strange and hilarious voices that you can produce. The very lowest pitch makes your voice sound like a robot, and the very highest pitch makes you sound like a chipmunk!

This project brings out the entertainer in everyone. Kids can put on puppet shows and use different voices to invent an endless number of characters. Or, watch them take the microphone and imitate their favorite super-stars. They can even sing and create their own music videos if you have a camcorder!

The voice changer is also fun over the telephone. You will be able to completely fool all of the people you call with your mysterious new voice or you can create amusing outgoing messages on your phone answering machine. No matter how you decide to use this exciting device, it is sure to give you and your

family hours of non-stop fun and entertainment.

Circuitry

Refer to the schematic of the voice changer shown in Fig. 1. The voice-changer circuit performs real-time digital signal processing (DSP) of a person's speech. The main circuit consists of IC1, IC3, and IC4 which make up a 2-stage microphone preamplifier, a signal-processing unit and an audio power amplifier.

The user's voice is picked up by the electret microphone (MIC1) and coupled to pin 2 of IC4-a, half of an LM358 dual op-amp. Resistors R6 and R9 set the gain of IC4-a at approximately 8 ($V_{OUT} = (R9/R6) \times V_{IN}$). The output of IC4-a is AC-coupled to the input (pin 14) of IC1, an MSM6322 speech pitch control IC made by OKI.

Figure 2 shows the internal function diagram of IC1 (the MSM6322). The input signal to pin 14 of IC1 passes through an amplifier with a gain of 10, which is set by external resistors R1 and R5. The output of that amplifier passes through a 4th-order low-pass filter (LPF1) to an 8-bit analog-to-digital converter (ADC). The ADC samples the speech signal at 8.33

kHz under the control of the data processing unit, and the 8-bit digital values are stored in the internal 1-kilobit RAM. Simultaneously, the data processing unit clocks the RAM data into a digital-to-analog converter (DAC) that restores the analog signal. As long as the speech data is clocked in and out of the RAM at the same rate, the original signal is reproduced with no change in pitch—this is the normal default mode of operation when the voice changer is first turned on. By pressing the SCALE button S1, the output sampling rate is changed according to the values listed in Table 1.

As the DAC frequency is increased, the signal pitch is shifted higher. Conversely, the pitch is lowered as the sampling frequency drops. The result is analogous to speeding up or slowing down a tape recording during playback. The restored audio output from the DAC passes through a second low-pass filter (LPF2) and a buffer stage to the output (A_{OUT} pin 11). The final amplification is provided by IC3, an LM386 audio power amplifier that drives the speaker (SPKR1). Capacitor C6 provides the AC coupling to IC3, and R3 controls volume.

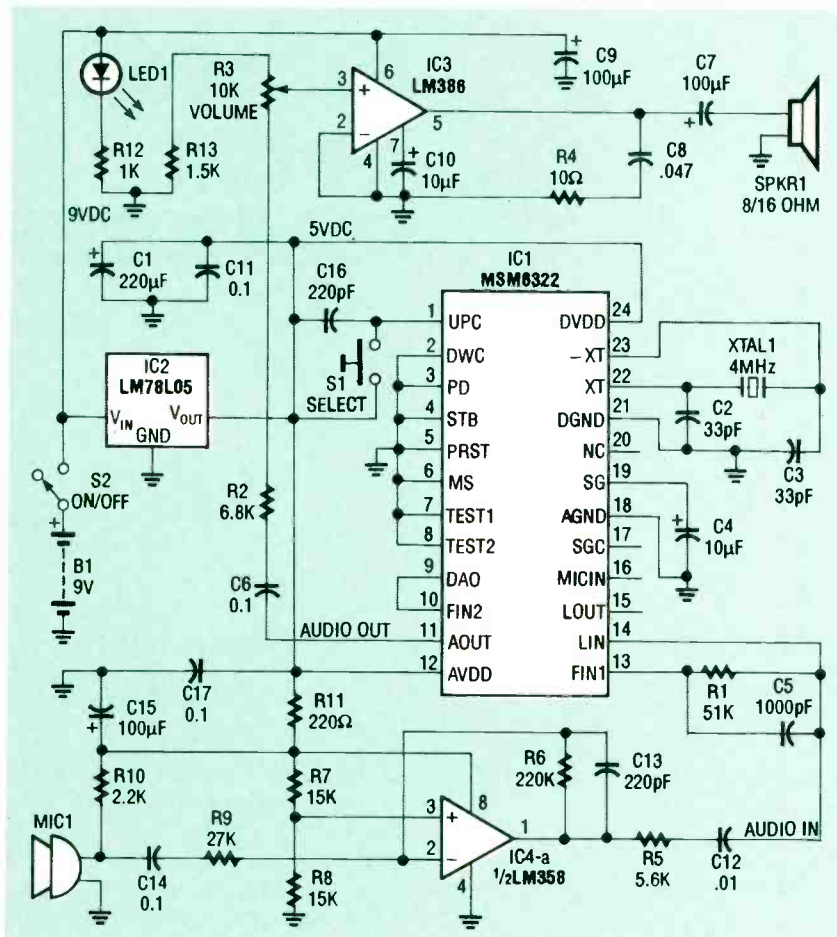
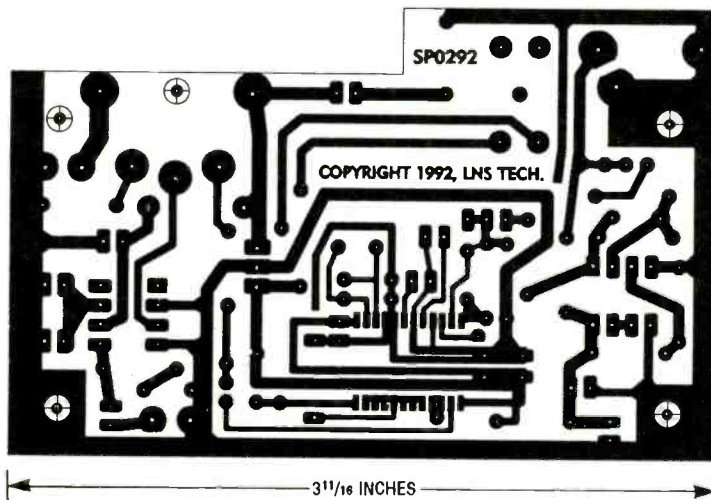

FIG. 1—VOICE CHANGER SCHEMATIC. The circuit performs real-time digital signal processing of a person's speech.



FOIL PATTERN for the voice changer board.

Assembly

The MSM6322 pitch control chip (IC1) is available from the manufacturer (OKI) only in a surface-mount package. The chip mounts directly to the foil side of the PC board (see the parts-placement diagram in

Fig. 3. To properly solder IC1, be sure to use a soldering iron with a very small tip and be extremely careful to avoid solder bridges. If you are not confident with soldering surface-mount devices, you can purchase the kit mentioned in the Parts List; in this

PARTS LIST

- All resistors are 1/4-watt, 5%.
 R1—51,000 ohms
 R2—6800 ohms
 R3—10,000 ohms, potentiometer with on/off switch (S2)
 R4—10 ohms
 R5—5600 ohms
 R6—220,000 ohms
 R7, R8—15,000 ohms
 R9—27,000 ohms
 R10—2200 ohms
 R11—220 ohms
 R12—1000 ohms
 R13—1500 ohms

Capacitors

- C1—220 — μ F, 10 volts, electrolytic
 C2, C3—33 pF, ceramic
 C4, C10—10 μ F, electrolytic
 C5—1000 pF, ceramic
 C6, C11, C14, C17—0.1 μ F, ceramic
 C7, C9, C15—100 μ F, electrolytic
 C8—0.047 μ F, ceramic
 C12—0.01 μ F, ceramic
 C13, C16—220 pF, ceramic

Semiconductors

- IC1—MSM6322 speech pitch control (OKI)
 IC2—LM78L05 5-volt regulator
 IC3—LM386N audio amplifier
 IC4—LM358N dual op-amp

Other components

- S1—momentary pushbutton switch
 S2—on/off switch (part of potentiometer R3)
 B1—9-volt battery
 MIC1—electret microphone
 SPKR1—8- or 16-ohm speaker, 2.6 inches square

Miscellaneous: PC board, UNIBOX #192 enclosure, 9 volt battery connector, IC sockets, knob for R3, wire, shielded microphone cable, hardware, solder, etc.

Note: The following items are available from LNS Technologies, 20993 Foothill Blvd, Suite 307R, Hayward, CA 94541-1511. 1-(800)-886-7150:

- MSM6322 Pitch Control IC (IC1)—\$15.00
- Complete kit of parts for the voice changer, including PC board (with IC1 pre-mounted & tested), enclosure, microphone, speaker, and all other components—\$59.00

Please add \$5.00 shipping/handling. California residents add local sales tax. COD, MC/VISA orders accepted.

kit, IC1 comes pre-soldered to the circuit board and has been tested.

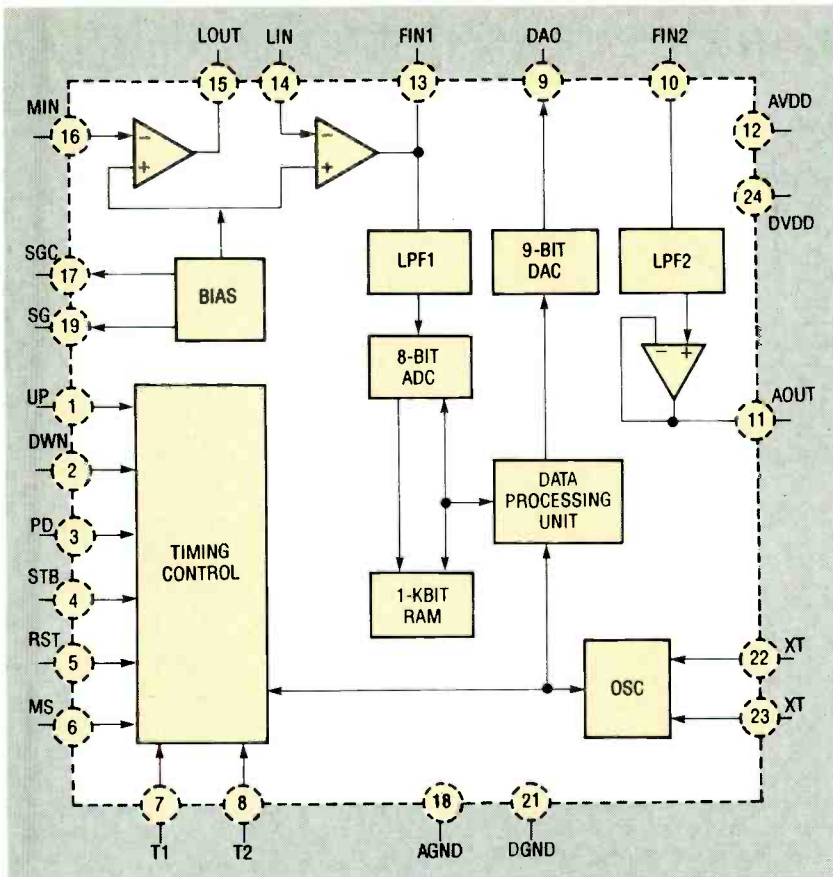

FIG. 2—INTERNAL DIAGRAM OF IC1. The input signal is amplified and then passed through a 4th-order low-pass filter to an 8-bit analog-to-digital converter which samples the speech signal at 8.33 kHz. The 8-bit digital values are stored in the internal 1-kbit RAM.

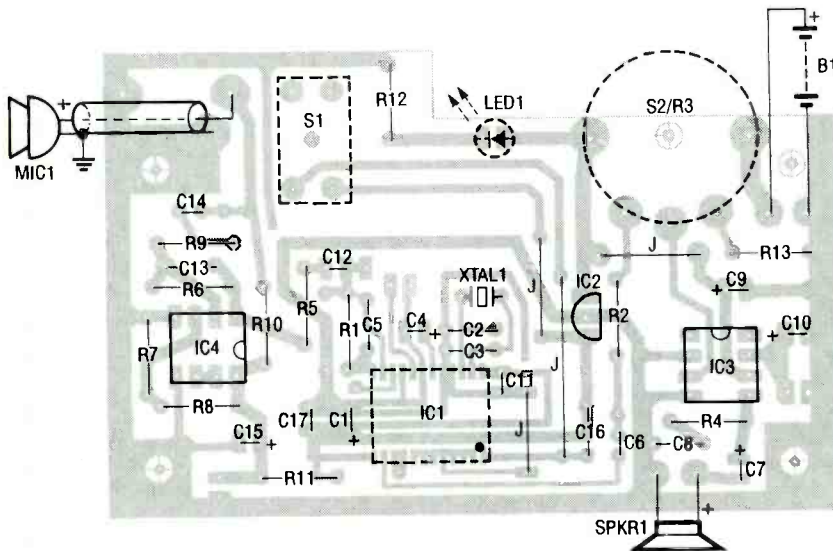

FIG. 3—PARTS-PLACEMENT DIAGRAM. IC1 is available only in a surface-mount package. The chip mounts on the foil side of the PC board. If you purchase the kit mentioned in the Parts List, IC1 comes pre-soldered to the circuit board. LED1, S1, and R3 also mount on the foil side to allow the parts to fit through the top of the enclosure.

Pay careful attention to the mounting holes on the PC board before you solder the ceramic capacitors. Because ca-

pacitors vary in size, the locations for C6, C12, and C14 have three holes to accept either large or small sizes.

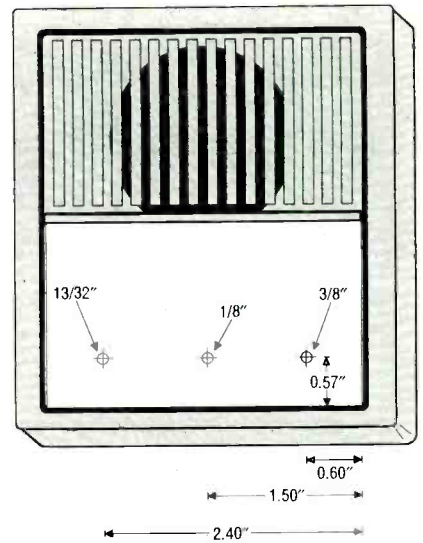

FIG. 4—DRILL THE THREE HOLES in the top cover for LED1, S1, and R3 as shown here.

The next three components (LED1, S1, and R3) are mounted on the foil side of the circuit board along with IC1. That allows the parts to fit through the top cover of the plastic enclosure. When soldering the LED in place, make sure that the bottom edge of the LED is $\frac{1}{4}$ -inch away from the board. Potentiometer R3 has on/off switch S2 built-in; the PC board has a special cutout to allow clearance of the switch mechanism. When the part is properly positioned, the five metal soldering rings will line-up with the corresponding pads on the PC board. After R3 has been soldered in place, you must remove the small metal tab sticking straight up from the edge.

Strip about $\frac{1}{2}$ inch of the outer insulation from the ends of a piece of shielded coaxial cable, and then strip about $\frac{1}{8}$ inch from the center conductor on both ends. Tin all loose ends of the cable. On the back of the electret microphone you will see that one of its two leads is directly connected to its metal case; this is the ground lead. Solder one of the coaxial cable's shield (outer) leads to the ground lead of the microphone. Then solder the center conductor to the other lead of the microphone. Insulate any exposed microphone leads with heat-shrink tubing or RTV silicone.

Connect the microphone wires into the PC board as

TABLE 1
PITCH CONVERSION TABLE

Step	D/A Sampling Freq (KHz)	Pitch Shift
8	16.6	One octave up
7	14.0	Major sixth up
6	13.1	Minor sixth up
5	12.5	Fifth up
4	11.1	Fourth up
3	10.5	Major third up
2	9.00	Minor second up
1	8.83	First up
0	8.33	No change (normal)
16	7.87	First down
15	6.99	Minor second down
14	6.62	Major third down
13	6.25	Fourth down
12	5.55	Fifth down
11	5.26	Minor sixth down
10	4.95	Major sixth down
9	4.40	Almost one octave down

case. The PC board should lie flat against the four plastic standoffs. If the board won't lie flat, check to make sure that you have removed the small metal tab from the potentiometer. Secure the PC board in place with four No. 4 × ¼-inch self-tapping screws.

Turn the case over and thread the washer and large nut back onto R3 to securely anchor everything in place. Slide the plastic knob onto the shaft of R3 and tighten the setscrew to hold it firmly in place. Cut or file a slot in the edge of the case for the microphone cable in so that it won't be pinched when you put the case together. Figure 5 shows the completed unit.

Operation

Install a 9-volt battery, turn the unit on, and set the volume control about halfway. The LED should light to show that the unit is receiving power. Keep the microphone away from the speaker or you will experience a loud feedback squeal. Each time the voice changer is turned on, it powers up in the normal mode, where there's no pitch change. If you speak into the microphone at this point, you should hear your normal voice from the speaker.

Each time you press switch S1, the pitch should rise one step. After 8 presses, the voice changer will be operating at the maximum high pitch shift (one full octave higher). On the 9th press of S1, the circuit should jump to the maximum low pitch shift (one octave down). The next 8 presses of S1 will cause the pitch to rise and finally return back to normal. The individual pitch change steps are shown in Table 1.

If your unit is working properly, you should experiment to see how your voice sounds at each of the steps. Also, you can bring the microphone near the speaker to produce feedback deliberately. The feedback in the normal mode is merely an annoying squeal, but with some of the pitch shifts, you will hear some interesting effects that sound like a spaceship or a ray-gun.

R-E

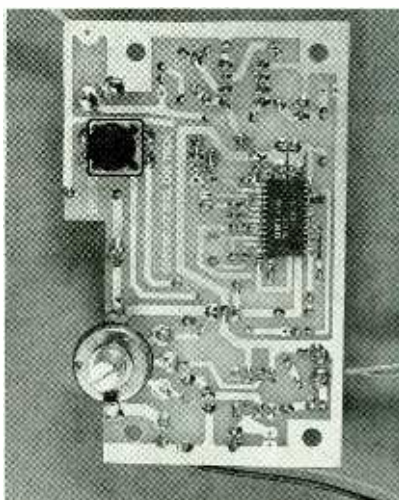
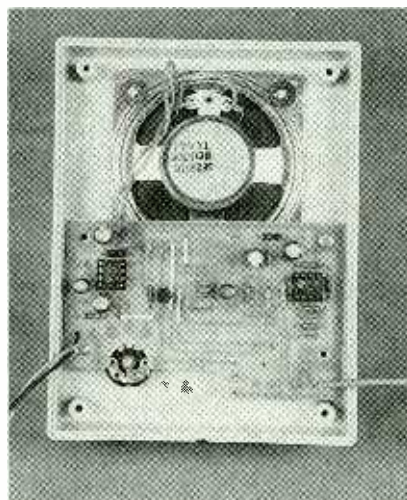
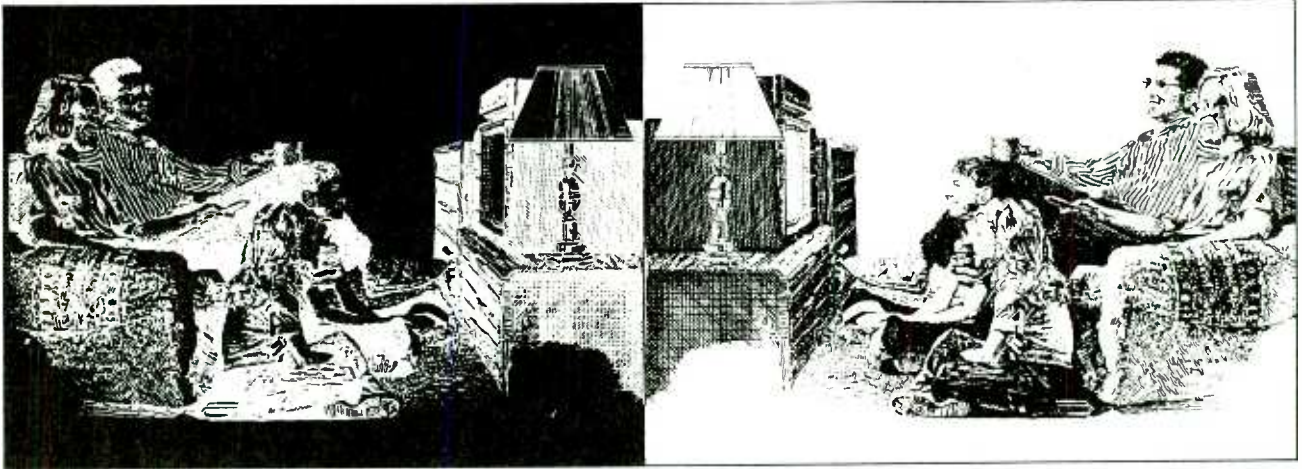

FIG. 5—THE INSIDE OF THE COMPLETED UNIT. Everything fits nicely inside the case, shown on the left. IC1 comes pre-mounted on the solder side of the board (right).

shown in Fig. 3. Now remove IC3 and IC4 from the protective foam and install each into its appropriate socket. Cut two pieces of insulated wire about 5 inches long and strip ¼ inch from all ends. Solder a wire to each terminal of the speaker and then to the PC board. Finally, attach the wires for the battery connector.

If you use the enclosure included in the kit, drill the three holes in the top cover as shown in Fig. 4. Then place the speaker over the 4 plastic pegs in the case and secure it in place. Next, remove the nut and washer from the potentiometer R3, and position the PC board so that S1, LED1, and S2/R3 protrude through the holes drilled in the



REMOTE CONTROL POWER SWITCH

Turn appliances on and off using any remote control with these IR switches.

JAIME LASSO*

IN RECENT YEARS, IT HAS BECOME easier than ever for an electronics hobbyist to build infrared (IR) remote-control devices. However, most IR systems are still too complex because they need tuning and encoding of some kind. If you're looking for a project that can be thrown together quickly and still work the first time you power it up, then try our universal appliance remote control receiver.

The device lets you control room lighting—or other line-powered devices—with any TV or VCR remote control. Since there's no need to build a transmitter, the project is simple; all you have to worry about is building a receiver.

Have you ever sat down to watch TV and forgot to turn on the room light? Well, now you don't have to wait for your kids or wife to walk by—you can do it yourself, instantly, since you already are holding the TV remote in your hand.

How it works

Most TV remote controls transmit a coded signal consisting of short bursts of a higher frequency (between 30 and 60 kHz). In our case, we don't care about the coded signal. All we care about is the very first pulse that the remote control transmits. Referring to the schematic in Fig. 1, IR pulses are detected by the combination of D1 (a Motorola infrared detector diode MC821) and IC1 (a Motorola MC3373 infrared amplifier/detector), which are the heart of the circuit. Those two components capture the pulse, demodulate it, clean it up, amplify it, and get rid of the power-line IR emissions, which are abundant in most areas.

Infrared signals are detected by the reversed-biased photodiode D1, and processed by amplifier-detector IC1, which provides a clean pulse at its output pin 1. This low-going pulse triggers a one-shot monostable multivibrator IC2-a (half of an MC74HC74) whose Q output (pin 5), in turn, goes low and stays low for about 2 seconds. The time is determined by C5

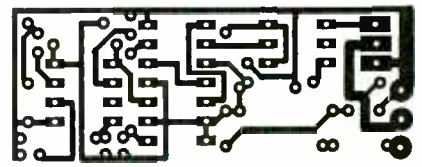

2 1/8 INCHES

FOIL PATTERN for the IR switch shown in Figs. 2 and 4.

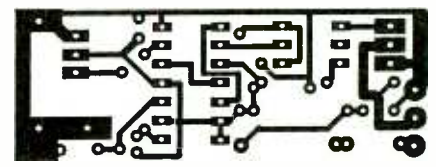

2 1/8 INCHES

FOIL PATTERN for the IR switch shown in Figs. 3 and 5.

and R4, and it can be varied to change the time delay of the timing cycle.

The time delay is necessary to convert the fast tone bursts from the transmitter into longer logic pulses that we can handle more easily. Once a signal is detected, IC2-a essentially latches on and remains low long enough for the incoming pulses to stop coming in. Once the cycle is over, IC2-a is again able to receive IR signals. That first

*Jaime Lasso is an applications engineer for Motorola, Inc.

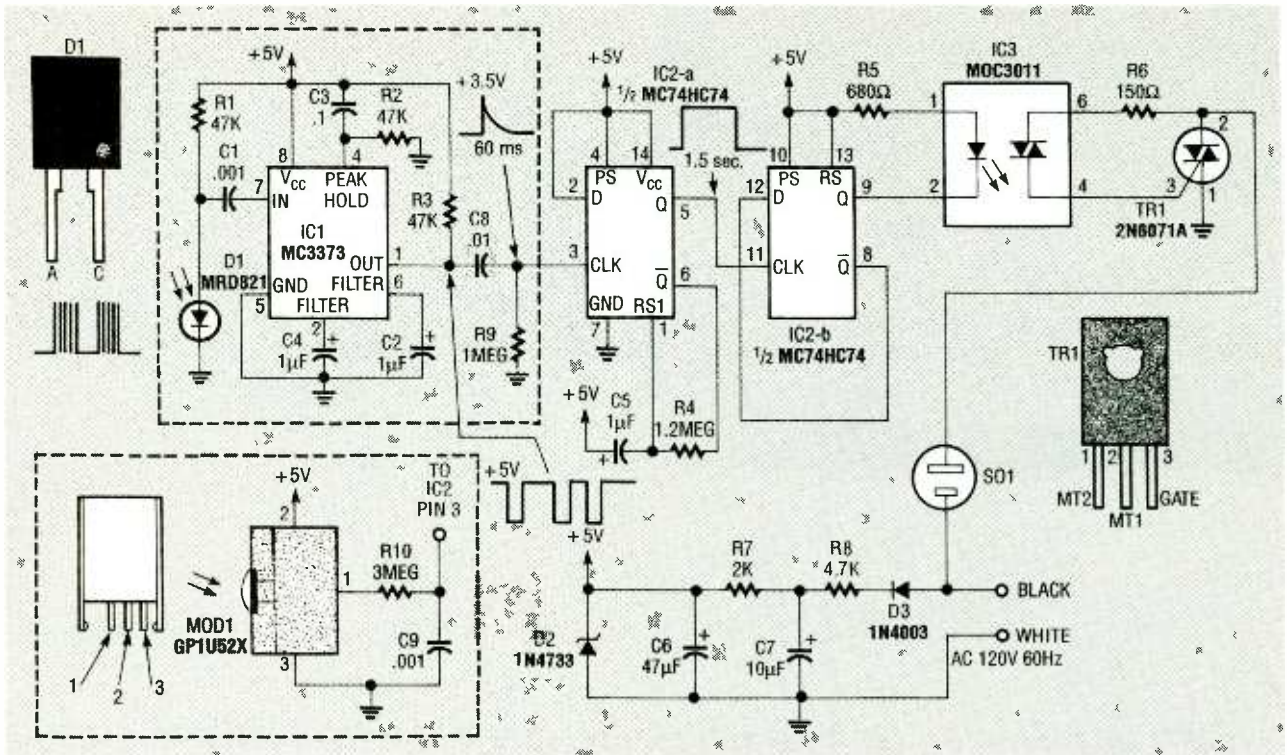

FIG. 1—THIS CIRCUIT WILL RESPOND TO ANY IR SIGNAL. Pulses are detected by detector diode D1 and infrared amplifier/detector IC1.

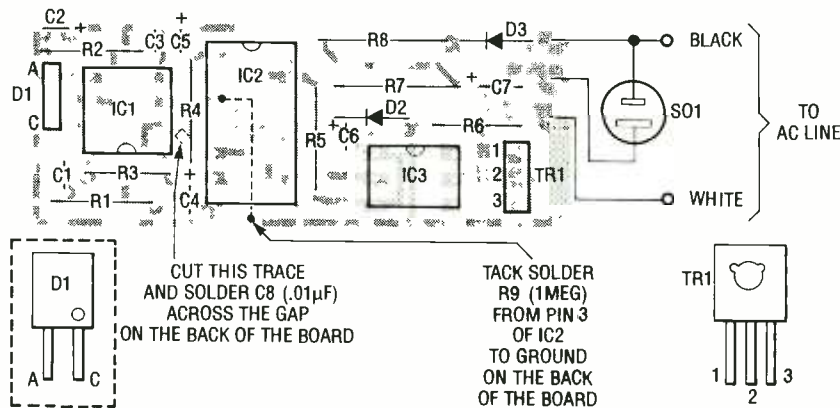

FIG. 2—PARTS-PLACEMENT DIAGRAM for the IR switch that contains D1 and IC1. TR1 must be placed with its metal side facing away from board, and the side of the photodiode (D1) with the dot on it must also face away from the board.

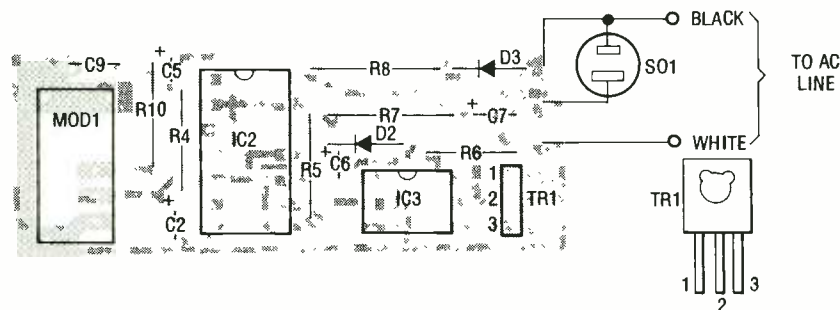

FIG. 3—PARTS-PLACEMENT DIAGRAM for the IR switch that contains MOD1. Use only the parts shown on this board, and disregard the parts that are used only on the other board.

pulse sets and resets flip-flop IC2-b, whose output (pin 9) powers the LED inside optocoupler IC3 (a Motorola MOC3011), which turns on the triac inside IC3. That turns on triac TR1, which supplies power to AC socket SO1 and the load.

When an IR signal is received once more, the Q output of IC2-b changes state, which disables the gate of TR1. Consequently, the next time the AC line voltage approaches zero, TR1 shuts off and so does the appliance plugged into SO1.

The IR detection circuitry—IC1 and the components surrounding it, shown inside the dashed box—can be replaced by the GPIU52X IR module (MOD1), also shown in a dashed box. The Sharp GPIU52X module (also available from Radio Shack as catalog No. 276-137) is an IR detector circuit by itself. You can use the parts that are easiest for you to get. Both circuits have a range of about 20 feet.

Assembly

Each of the two IR detection circuits makes use of a different PC board, so we've provided the

Continued on page 90

Learn the fundamentals of crystal resonators —how and why they work in oscillators and frequency standards.

DAN BECKER

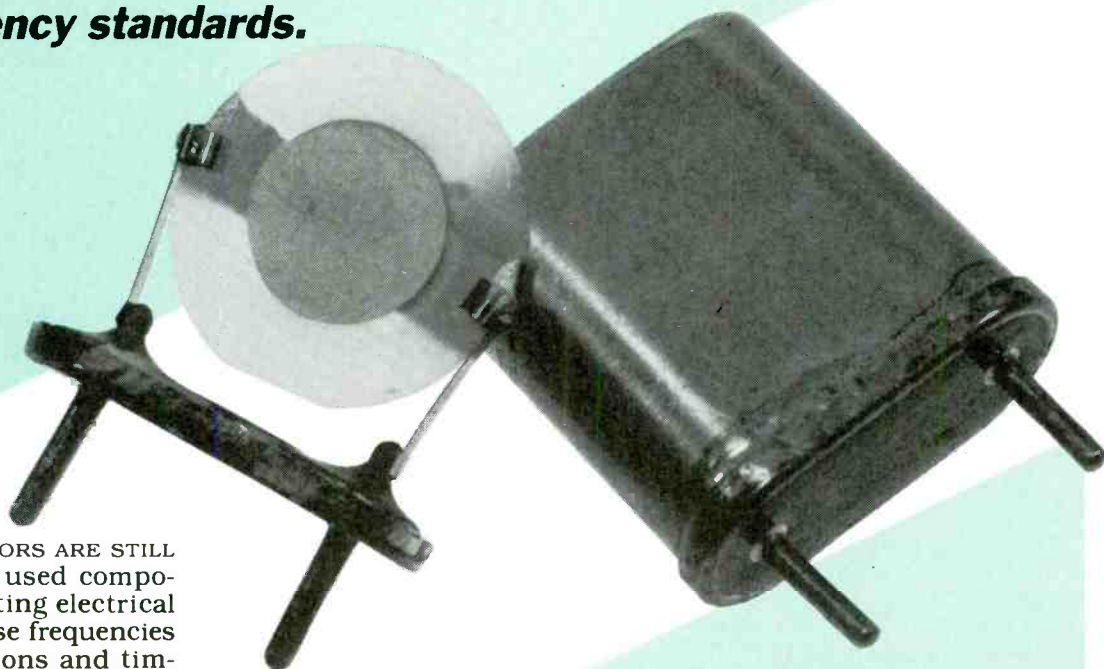

CRYSTAL RESONATORS ARE STILL the most widely used components for converting electrical energy into precise frequencies for communications and timing. Among the many instruments, products, and systems that depend on crystals to produce their precise, stable frequencies are frequency counters, radio transmitters, electronic navigation systems (transmitters and receivers), TV sets, and VCR's.

This article reviews the fundamentals of crystal resonators. Because of their utility and low cost, it emphasizes those made from quartz—how and why they work. The distortion of crystal resonators by the application of an alternating voltage across its faces is explained by the piezoelectric effect. Although synthetically produced quartz is still the leading material for manufacturing piezoelectric resonators, many other natural and man-made materials exhibit similar properties.

The information presented here is an introduction to the second installment in this series addressing the design and application of crystal-controlled oscillators such as the Colpitts, Pierce, and Butler. These oscillators, originally designed as vacuum-tube oscillators, have been adapted to transistors, and they include crystal resonators.

CRYSTAL OSCILLATORS

Armed with the information we'll present on the mechanical and electrical properties of crystal resonators, you'll have a better understanding of how to purchase and use low-cost crystals in your experiments or electronic projects.

Properties of crystals

The starting point in this subject is crystallography, the study of the form, structure, properties, and classification of crystals. This specialized subject linking physics, chemistry, geology, and mechanical engineering, is usually touched on only briefly in formal electronics engineering courses. With the wealth of subject matter to cover, instructors rarely say much about crystal resonators except to note that they are readily available components and can be viewed as electrically

equivalent to high-Q LCR tank circuits.

Crystallography deals with lattices, bonding, and the behavior of slices that have been cut at various angles with respect to the crystal's axes. The mechanical properties of crystal lattices permit the important piezoelectric effect. Sections of crystal blanks that have been cut and polished according to well known rules vibrate when alternating voltages are applied across their faces.

The dimensions of the crystal slice—particularly its thickness and where and how it was cut from the blank—determine its electrical and mechanical properties. Other factors are the form of the electrodes and how the crystal is supported.

A resonant crystal's behavior can be simulated as either a parallel or series tank circuit with

capacitors, an inductor, and a resistor. As tank circuits, crystals have figures of merit or Q s that are orders of magnitude superior to those of discrete-component resonant circuits.

Piezoelectric effect.

To understand how and why a crystal resonates as a tank circuit, it is necessary to understand the *piezoelectric effect*. Occurring in both man-made and natural crystals, there are two reciprocal modes to this effect. The first, as shown in Fig. 1-a, is the generation of a voltage between the opposite faces of a piezoelectric crystal as a result of stressing the crystal along its longitudinal axis.

The stress can take the form of squeezing (compression), stretching (tension), twisting (torsion), or shearing. In fact, if the crystal is stressed periodically, the output voltage will be alternating. This effect can be seen by observing needle swing on a high-impedance voltmeter or as an alternating wave on an oscilloscope.

The second mode, shown in Fig. 1-b, is the mechanical deformation of the crystal caused by the application of a voltage across the opposite faces of the crystal. The degree of deformation will depend on the characteristics of the drive signal as well as those of the crystal cut. The application of an AC signal will produce periodic longitudinal, shearing or flexural motion.

In Fig. 1 the electrodes make the electrical connection to an external drive or output circuit. Here the thickness of the electrodes has been exaggerated; in practical resonators they are thin films of metal deposited on the opposing faces of the thinnest section of crystal, similar to the plates of a ceramic-disc capacitor.

The piezoelectric mode shown in Fig. 1-a is applied in crystal microphones, strain gauges, and receiving elements in depth sounders, for example. In those applications they are known as transducers. By contrast, the applications for the mode illustrated in Fig. 1-b

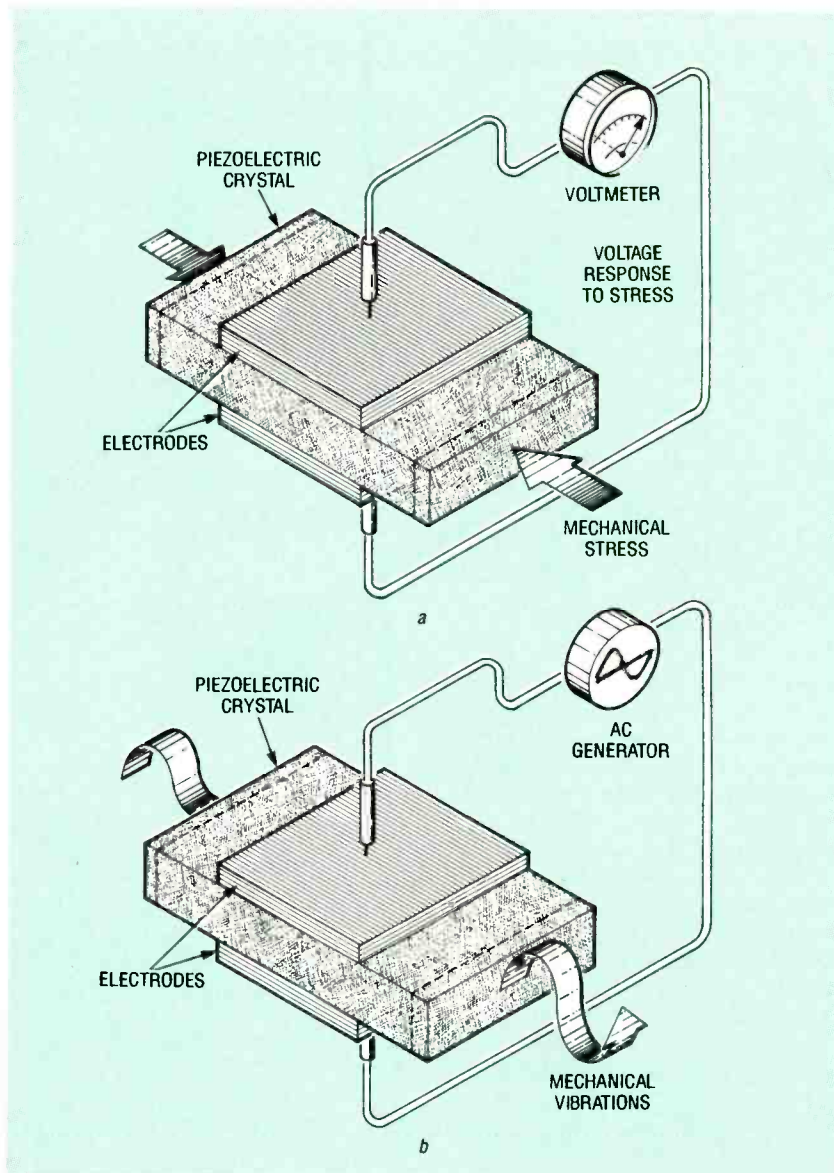

FIG. 1—THE PIEZOELECTRIC EFFECT IS RECIPROCAL. Stressing the crystal will generate a voltage which causes the meter needle to jump, a, and applying an alternating electrical signal across the electrodes will cause the crystal to be mechanically deformed, b.

include frequency standards for telecommunications, as frequency generators, and as time standards in watches, clocks and timebase generators. That mode is also applied in ultrasound generators and cleaning machines, and the transmitting elements of depth sounders, where they are also known as transducers. In depthsounders and ultrasonic diagnostic equipment, the transducer can function both as a transmitting and receiving element.

The piezoelectric effect is exhibited by many natural and man-made crystals; the most important natural crystals are

quartz, Rochelle salt, and tourmaline. There are also many man-made piezoelectric elements such as ADP, EDT, and DKT that are used as filters and transducers. However, synthetic quartz is still the most widely used material for oscillator frequency control because of its permanence, low temperature coefficient, and high mechanical Q .

Crystal resonance

The mechanical resonant frequency of a crystal can be determined by applying an alternating voltage from a signal generator (whose range extends

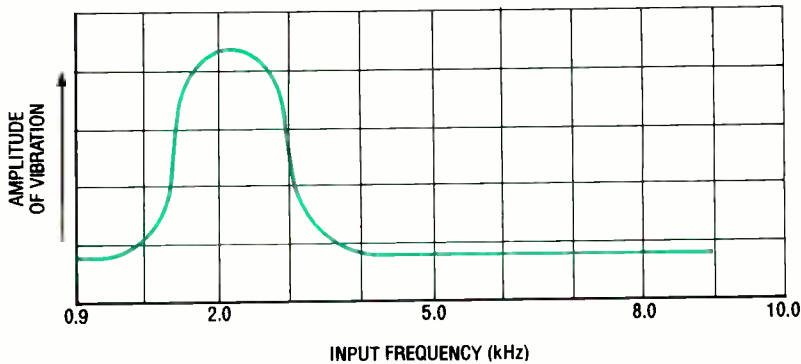

FIG. 2—A CRYSTAL'S RESONANT FREQUENCY can be determined by sweeping the input frequency until an amplitude peak representing mechanical resonance is seen on an oscilloscope.

over the likely resonance frequency) across the crystal faces. As shown graphically in Fig. 2, the applied frequency is slowly changed while observing the amplitude of the trace on an oscilloscope, the resonant frequency of a piezoelectric crystal under test can be found visually. The mechanical resonance of the crystal shown occurs at about 2.2 kHz.

The mechanical vibrations within a piezoelectric crystal slice are called *bulk acoustic waves* (BAW's). In general, the thinner (and smaller) the crystal slice, the more rapid will be the mechanical vibrations and the higher will be its resonant frequency.

Figure 3 is a perspective drawing showing various crystal cuts from a quartz blank. The orientation of the cut with respect to the blank's major crystallographic axes strongly influences its piezoelectric properties and temperature stability.

There are three principal crystal axes: X, Y, and Z (known as the *optical axis*). Figure 3 shows some of the most popular cuts and how they are oriented with respect to each other. They are designated by two letter symbols. Examples are AT, BT, CT, DT, ET, AC, GT, and JT. The angles shown relate the edges of the cuts to the blank's principal axes.

Each cut has special characteristics. The AT cut is the most popular for high-frequency and very-high frequency crystal resonators. The AT cut exhibits high frequency shear and pro-

duces a fundamental in the 800 kHz to 25 MHz range. However, it overtones (to be discussed later) permit operation up to 200 MHz. The CT and DT cuts exhibit low-frequency shear and are most useful in the 100- to 500-kHz range. The MT cut vibrates longitudinally and is

Practical resonators

useful in the 50- to 100-kHz range while the NT cut flexes and has a useful range under 50 kHz. The resonator is supported on

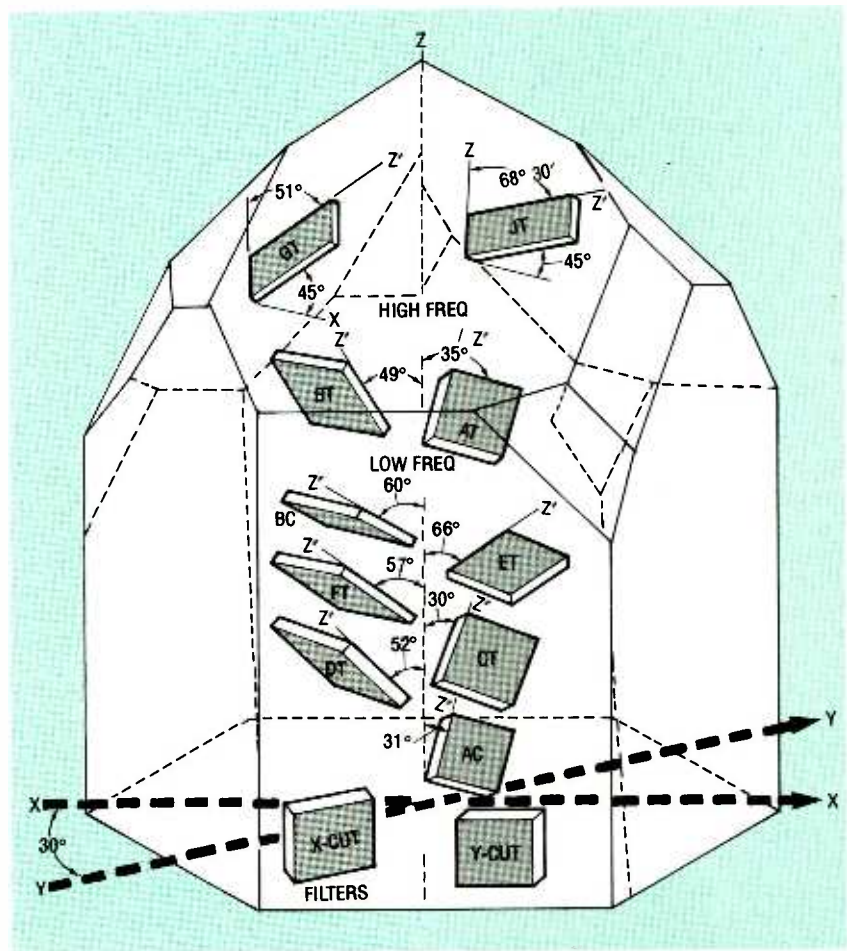

FIG. 3—CRYSTAL SLICES ARE CUT FROM A QUARTZ blank at different angles with respect to the axes to yield different mechanical and electrical characteristics.

each edge at *nodal points*, places where the support will provide least damping of the vibrating crystal. Flexible support struts bonded to each side of the crystal connect the electrodes to base pins.

Crystal manufacturers refer to the complete assembly of

47

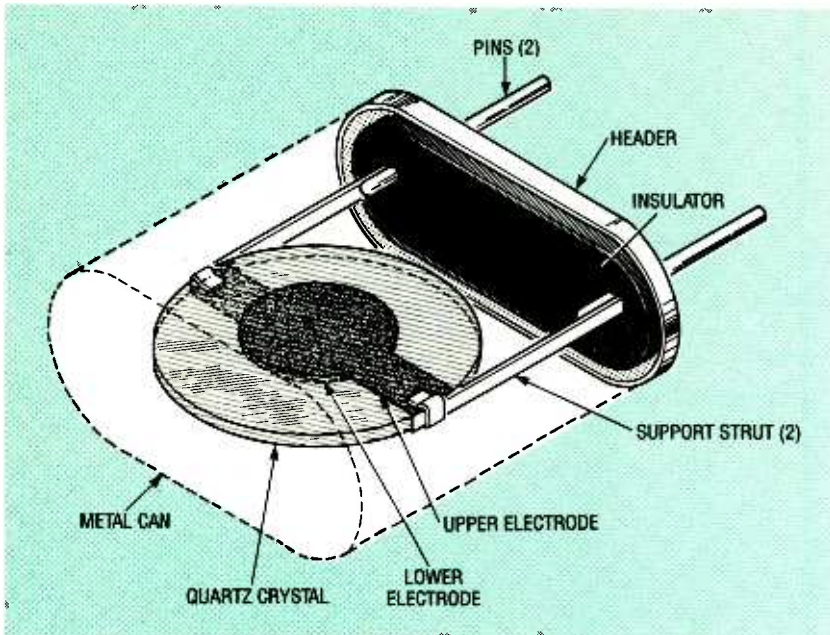

FIG. 4—A QUARTZ-CRYSTAL RESONATOR with its case removed. The silvered electrodes are on opposite sides of crystal disk and the disk is supported at its nodal points.

crystal, support, and case as a holder. The insulated pins in the base of the holder are for external electrical connections. The flat metal case is either soldered or welded to the base to form a hermetic seal. Sealing is typically done in a vacuum chamber which might also contain an inert gas such as nitrogen to provide additional protection for the crystal against contamination. It is essential that all moisture be removed from the case. The removal of air from the holder reduces the crystal's mechanical load and affects its resonant frequency.

Series and parallel resonance

Crystal resonators can be modeled near resonance with the equivalent circuit shown in Fig. 5. The series combination L_s , C_s , and R_s represent the electrical equivalent of the vibrational characteristics of the crystal by itself. The inductance L_s is the electrical equivalent of the crystal mass that is effective in vibration, C_s is the mechanical equivalent of the effective mechanical compliance, and R_s represents the electrical equivalent of mechanical friction.

This equivalent circuit is modified, however, when the crystal is mounted in the crystal holder. As a result, the equiv-

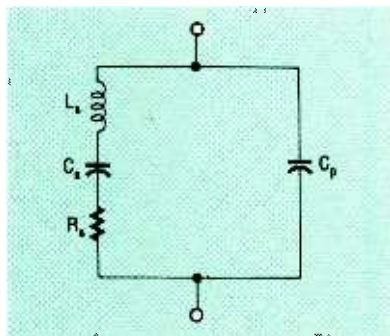

FIG. 5—IN AN EQUIVALENT CIRCUIT FOR A CRYSTAL resonator, L_s , C_s , and R_s represent the crystal, and C_p represents the capacitance of electrodes and holder.

alent circuit of the mounted crystal is the parallel circuit shown in Fig. 5. Capacitor C_p represents the electrostatic capacitance between the crystal electrodes and the stray capacitance associated with the holder when the crystal is not vibrating.

At series resonance, the reactances of C_s and L_s cancel out, leaving resistor R_s and a small amount of capacitive reactance from static capacitor C_p . At a frequency slightly above series resonance, f_s , the reactance of C_p cancels out and the crystal looks resistive. The value of this resistance is called the *equivalent-series resistance*. Manufacturers usually specify only a

maximum value of ESR because precise values are seldom needed in oscillator design. Crystals made to operate at series resonance are called *series-resonance crystals*.

A series-tuned circuit is capacitive below its series-resonant frequency f_s and inductive above it. The series-resonant frequency is given by:

$$f_s = \frac{1}{2\pi\sqrt{L_s C_s}}$$

At some frequency f_p , which is higher than f_s , the crystal will act as a parallel-tuned circuit because the now inductive series branch resonates with C_p . Crystal resonators made to oscillate above series resonance are called *parallel-resonance crystals* or *load-resonance crystals*. The parallel resonant frequency is:

$$f_p = \frac{1}{2\pi\sqrt{L_s C}} \quad \text{where}$$

$$C = \frac{C_s C_p}{C_s + C_p}$$

Crystal resonators intended for parallel-resonance operation include a specification called the *load capacitance*, abbreviated C_L . Typically 10 to 100 picofarads, it is called load capacitance because it is the capacitance value that the oscillator circuit presents to the crystal, that is, the crystal's load.

Load capacitance can be approximated as a 10 to 100 picofarad capacitor in series with a series-resonant circuit (the crystal). If the load capacitance is decreased, the resonant frequency of the total circuit (crystal plus load capacitor) will increase. As frequency increases, the crystal becomes more and more inductive. Most oscillator circuits call for an inductive crystal resonator. Therefore, parallel resonance crystals are very popular.

Series vs. parallel.

In an oscillator circuit a paral-

lel-resonance crystal is usually more stable than a series-resonance crystal. The parallel-resonance crystal's change in inductive reactance per change in frequency ($\Delta X/\Delta f$) is greater above series resonance than at series resonance. This sharpens the tuning of the feedback network. Therefore, noise signals higher or lower than the resonant frequency are quickly damped out. This prevents off-frequency oscillation.

Figure 6 summarizes crystal resonator characteristics by plotting reactance vs. frequency. In the parallel resonance region, the magnitude of the crystal's resistance increases above its ESR value. Manufacturers usually refer to this as the crystal's maximum resistance with load capacitance or, the crystal's *load resistance*.

The frequency at which the inductive reactance abruptly changes to capacitive reactance (and resistance approaches a maximum), is called *anti-resonance*. It is not specified in data sheets for most oscillator applications.

Table 1 gives typical values for a selection of crystal resonators. The columns headed C_s , L_s , and R_s are the series values and C_p represents parallel capacitance. The C_L column is load capacitance and the R_L column is load resistance.

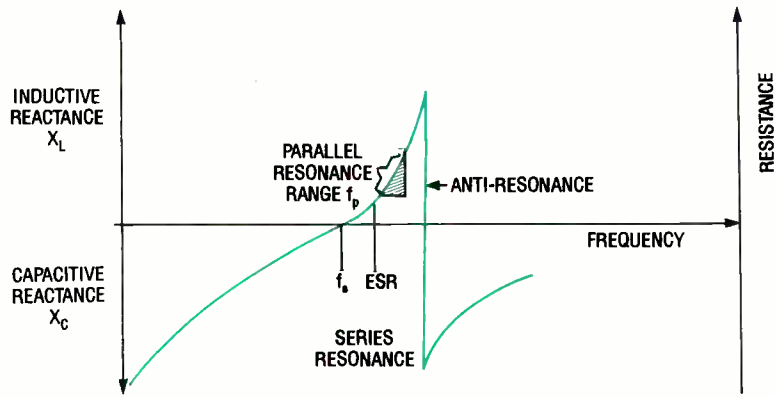

FIG. 6—CHARACTERISTICS OF CRYSTAL RESONATORS: parallel resonance, and series resonance are shown.

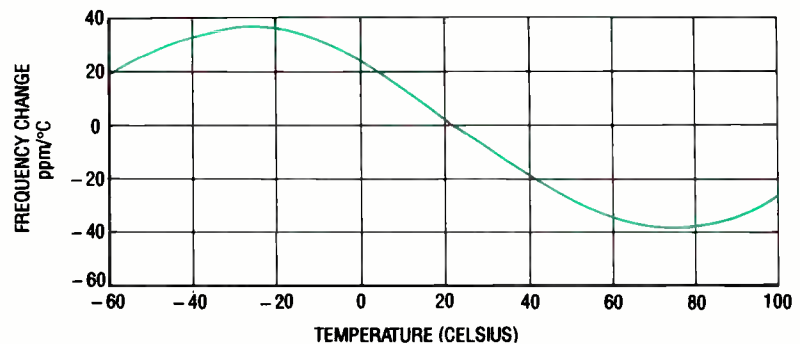

FIG. 7—Plot of frequency change with respect to temperature for a typical AT-cut crystal resonator.

that for high frequency oscillation, the quartz wafer must be very thin. This fact makes it difficult to manufacture crystal resonators with fundamental frequencies much above 30 MHz because the crystal is so thin that it is exceptionally frag-

it possible to achieve fundamental frequencies up to about 350 MHz, but this process is more costly and it increases the cost of those resonators.

Resonant frequencies higher than 30 MHz have been obtained by making use of harmonically related vibrations that occur simultaneously with the fundamental vibration. The harmonics are odd multiples of the fundamental (3, 5, 7 and 9) and they are referred to as *overtone* because they are not true harmonics. The tradeoff is that special provisions must be made in oscillator circuits to enhance those overtone frequencies.

Manufacturers can process a crystal so that one overtone is stronger than the others. Typically, overtone crystals are available for the 3rd, 5th, 7th, or 9th mode of vibration. Thus a 30-MHz, third-overtone crystal actually has a 10-MHz fundamental, but the crystal is cut to enhance its third mode. Low-cost overtone crystals with frequencies up to 200 MHz are

TABLE 1
TYPICAL VALUES FOR A CRYSTAL EQUIVALENT CIRCUIT

CRYSTAL f (MHz)	C_s (pF)	L_s (mH)	R_s (ohms)	C_p (pF)	C_L (pF)	R_L (ohms)
0.100	0.004	633	62k	4	20	90k
1.0	0.028	905	388	7	32	575
10	0.028	9.0	16	7	32	24
20	0.028	2.2	40	7	Series Resonance	
80	0.0012	3.3	50	7	Series Resonance	

Other characteristics.

The relationship between a quartz crystal's thickness and resonant frequency is expressed as $h = 65.5/f_R$, where h is the thickness in inches, and f_R is the resonant frequency in kilohertz. This formula says

ile and conventional cutting and polishing could result in high production cost.

Some crystal resonator manufacturers get around this problem by using chemical etching to achieve thinner slices of quartz. This has made

Earn Your B.S. Degree in ELECTRONICS or COMPUTERS



By Studying at Home

Grantham College of Engineering, now in our 42nd year, is highly experienced in "distance education"—teaching by correspondence—through printed materials, computer materials, fax, and phone.

No commuting to class. Study at your own pace, while continuing on your present job. Learn from easy-to-understand but complete and thorough lesson materials, with additional help from our instructors.

Our Computer B.S. Degree Program includes courses in BASIC, PASCAL and C languages — as well as Assembly Language, MS DOS, CADD, Robotics, and much more.

Our Electronics B.S. Degree Program includes courses in Solid-State Circuit Analysis and Design, Control Systems, Analog/Digital Communications, Microwave Engr, and much more.

An important part of being prepared to *move up* is holding the right college degree, and the absolutely necessary part is knowing your field. Grantham can help you both ways—to learn more and to earn your degree in the process.

Write or phone for our free catalog. Toll free, 1-800-955-2527, or see mailing address below.

Accredited by
the Accrediting Commission of the
National Home Study Council

GRANTHAM
College of Engineering
Grantham College Road
Slidell, LA 70460

available as standard commercial products. More expensive chemically-milled resonators can have overtones up to about 500 MHz.

Temperature stability

A crystal's resonant frequency changes with temperature. Crystal manufacturers express temperature-related changes in parts per million per degree Celsius (ppm/°C). Figure 7 is a plot of resonant frequency change with temperature for a typical low-cost AT-cut crystal.

When a desired operating temperature is specified, a manufacturer fabricates the crystal so that its optimum stability point (zero ppm/°C on Fig. 7) corresponds to that temperature. For low cost units, this is 25°C.

To find the maximum frequency change, locate the ppm/°C value corresponding to the given temperature. Next, multiply ppm by the nominal operating frequency (in megahertz). For example, at -20°C, a crystal can have a +38 ppm/°C rating. If its resonant frequency is specified to be 10 MHz (at 25°C), its resonant frequency will increase by 380 Hz when its temperature drops to -20°C (38 ppm × 10 MHz).

For most practical circuits this represents a minor frequency change. However, if strict frequency control is required in any application, a crystal oven or temperature-compensated oscillator (TCXO) should be included.

Calibration tolerance.

A crystal's true frequency might not be exactly the same as the value stamped on its case. The error depends upon the crystal's calibration tolerance. Moreover, its calibration tolerance is specified at one specific temperature, usually 25°C. For example, expect a 10-MHz crystal with a ± 25 ppm/°C calibration tolerance to have a resonant frequency within ± 250 Hz of 10 MHz when operating at 25°C.

Aging

Aging is a gradual change in a crystal's resonant frequency

with respect to time. It is usually specified in parts per million per year (ppm/year). Typical values range from 3 to 10 ppm/year. For example, a 10-MHz crystal with an aging rate of 10 ppm/year can change by 100 hertz per year. One cause of aging is the redistribution of particles of quartz and embedded grinding compound that were not removed by careful cleaning.

These microscopic materials remain within the holder after hermetic sealing and are redistributed as a result of resonator vibration. Thus aging is directly affected by the power input or drive level.

In addition, slow leaks in the hermetic seal can allow air, moisture and contaminants into the case which will shift the resonant frequency. Stresses on the electrodes and changes in atmospheric pressure that flex the outer walls of the case can also contribute to the aging of a crystal.

Power dissipation.

As with any object that is vibrating at its resonant frequency, the vibrations can quickly build to a destructive level. To maintain temperature stability and to avoid damaging the crystal resonator, each crystal has a recommended maximum drive level. Typical maximum values range from 5 milliwatts at low frequencies to 0.1 milliwatt at high frequencies because high-frequency crystals are thinner than low frequency crystals.

Standard holders

The holders were standardized by a military specification years ago, and they are still referred to as HC numbers (for HC-XXU) to identify resonator type and size. Crystal resonators are available from stock with resonant frequencies from about 70 kHz to 200 MHz. Specials can be ordered as custom items. We wish to acknowledge the assistance of Royden Free-land of International Crystal Mfg., Co. Oklahoma City, OK, in checking this manuscript for accuracy.

R-E



THOMAS E. BLACK

YOU SLIP THE FLOPPY IN YOUR A: drive, copy the files to your hard disk—and discover that you forgot the latest update to the report you worked on last night at home. What do you do? Make the trip back home, possibly wasting hours in the process? Not if you have Ring-Thing. In that case, you just dial home, boot your PC, and download the file directly to your office. Ring-Thing is also useful for consultants and anyone who needs occasional remote access to a PC, but who doesn't want to leave his or her PC on all the time, risking intrusion by hackers.

Ring-Thing acts as an interface between your phone line and an AC power strip, as

shown in Fig. 1. When Ring-Thing recognizes a set number or pattern of ring signals, it turns on a relay that applies 117 VAC to whatever is plugged into the power strip. After the phone connection terminates, Ring-Thing waits 5–6 minutes and then removes power from the power strip. Ring-Thing can control IBM compatibles, Macintoshes, Amigas—even non-computer equipment. And a special software module allows special tricks with an IBM compatible PC.

An on-board 68HC705 microcontroller provides simple operation and sophisticated features, summarized in Table 1.

You can order a complete kit of parts for about \$80, and partial kits containing hard-to-

find parts, commercial-quality double-sided PC boards, and software. The RE-BBS (516-293-2283, 1200/2400, 8N1) also carries the software: look for file RINGTHNG.EXE, a self-extracting archive that contains C++ source and object code for the optional IBM control module, and a Motorola format hex file containing the object code for the microcontroller. Firmware source code is not available.

Operating modes and controls

Ring-Thing has two jumper-selected modes of operation: Ring Counting and Ring Pattern.

Ring Counting (Standard Mode) After one or ten rings (jumper selectable), Ring-Thing

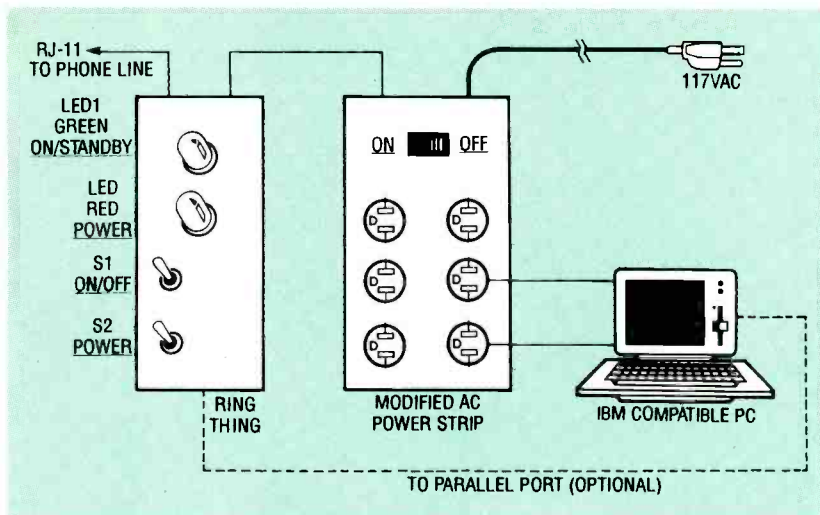

FIG. 1—RING-THING ALLOWS THE REMOTE CONTROL of any AC-powered device via standard telephone lines. An optional PC interface allows computer-controlled power-downs.

TABLE 1—RING-THING FEATURES

- Microprocessor-based design for user-friendly operation
- Compatible with all computer equipment
- Compatible with all standard business and home telephone lines
- Modular two-piece design for convenient mounting
- Automatically controls computer equipment power during modem or PC fax connection
- Provides security for computer modems
- Provides convenient manual on/off power control for computer equipment
- Computer-controlled power-down mode

MAIN BOARD PARTS LIST

All resistors are ¼-watt, 5%, except as noted

- R1, R22—470 ohms
 R2, R7, R8, R10, R11, R12, R13, R21—100,000 ohms
 R3, R4—47,000 ohms
 R5—22 ohms
 R6, R17—10,000 ohms
 R9, R14—470,000 ohms
 R15—1000 ohms
 R23—1000 ohms, ½ watt

Capacitors

- C1, C2, C4, C5, C10, C11, C12, C13, C15—0.1 µF, 50 volts, monolithic, radial
 C3, C6, C16, C18—10 µF, 16 volts, electrolytic, radial
 C7, C8—27pF, 100 volts, COG ceramic (see text)
 C9, C14—0.01 µF, 100 volts, polyester, radial
 C17—470 µF, 25 volts, electrolytic, axial

Semiconductors

- IC1—MC68HC705K1, 8-bit CMOS microcontroller
 IC2—LM358N, low-power dual op-amp
 IC6—74HCT14, CMOS hex inverter
 IC7—CD4001, CMOS quad NOR gate

IC8—LM2931T-5.0, low-dropout regulator

- BR1—W005 or RB151, 50-volt, 1-amp diode bridge
 D1, D4—1N4148 or 1N914, switching diode
 D2, D3, D5, D6, D10, D11, D12—1N4003, 200-volt, 1-amp rectifier diode
 LED1—T1-¾ green LED
 LED2—T1-¾ red LED
 MOV1—130-volt, 11–15 Joule surge suppressor
 Q1—PN2222, general-purpose transistor

Other Components

- JU1, JU2—2-pin header with shorting block
 XTAL1—4.00-MHz quartz crystal, HC18 - HC49 pkg, or 4.00-MHz resonator (see text)
 SPKR1—8–16 ohms speaker, 1–2"
 S1, S2—switch, SPST, NO, momentary, pushbutton, panel mount
 Modular telephone cord, 6 feet
 Four-conductor cable, 22 AWG, 6 feet
 IC Sockets, enclosure, screws, circuit board, etc.

applies AC power to the power strip. When the computer boots, the modem (or Fax) seizes the phone line to allow remote communications. One

ring is best for Fax transmissions, ten for modem communications.

Ring Pattern (Shared Mode)
 Similar to Ring Counting mode,

except that AC power is enabled only if the caller allows the phone to ring 1–3 times, hangs up, and then calls back within 45 seconds. Pattern mode provides additional security over Counting mode; it also allows you to share one phone line among several devices, for example, by setting an answering or Fax machine to answer on the fourth ring.

Call duration of both modes is indefinite. As long as your modem or Fax adapter continues to seize the line, Ring-Thing will apply power. Five minutes after your device relinquishes the line, Ring-Thing removes power. The delay allows you to reestablish the connection if the phone call terminates accidentally.

Two front-panel pushbutton switches control Ring-Thing's operation: ON/STANDBY and POWER ON/OFF. They operate as follows.

ON/STANDBY enables remote control, indicated by an illuminated green LED, which also blinks when the phone line is in use.

POWER ON/OFF functions in place of the ON/OFF switch on the AC power strip to control power to all equipment plugged into the strip. Rather than fumble for the main switch on your power strip, you now simply tap this button to turn on your equipment. As a safety feature, you must push and hold the button momentarily to turn your equipment on or off. The adjacent red LED illuminates when the computer has been turned on manually. The LED blinks slowly if power was enabled by the phone ring mode; a faster blink rate indicates that power will shut off automatically within two minutes.

Remote control

Activating the system for remote control by a PC takes five simple steps.

1. Set your modem (or Fax board) to answer on 1–4 rings. See your board's documentation for instructions on how to do that.

2. Set up your computer so that your favorite modem (or Fax)

communications program executes automatically after the computer boots.

3. Plug Ring-Thing into the same telephone jack that your modem (or Fax board) uses. You can use the jack on the back of your modem (or Fax) usually labeled "Line."

4. Plug your computer, monitor, and other peripherals into Ring-Thing's AC power strip. Leave the power switches of the Ring-Thing's power strip and all the computer equipment in the on positions.

5. Plug in the Ring-Thing and enable Ring Detection by pressing ON/STANDBY.

At this point, Ring-Thing is armed and ready for action.

Optional power down

Have you ever started a program that you knew wouldn't finish for hours—like printing the OS/2 documentation files? Just start the program and let Ring-Thing power your PC down when it's through. This feature does not involve the tele-

phone system at all. What it does is allow a PC user to turn the computer's power off from within DOS.

By connecting Ring-Thing to a spare LPT port, you can use RT.EXE to send a power-off command. The command can be issued directly from the keyboard, or indirectly via a DOS batch file. Sixty seconds later, whatever is connected to the Ring-Thing will be turned off. The delay allows the computer to perform other batch operations (e.g., parking the hard drive). Power-down mode works with both ring-detection modes.

To send the power-down command while connected to LPT2, type the following: RT /LPT2 /OFF, followed by the ENTER key. You will hear a one-minute warning beep, and the red LED will flash. After one minute, the PC will shut off. To cancel power-down mode, merely tap S2.

Circuit overview

Ring-Thing consists of two

main functional units: the AC power strip and the control unit, as shown in Fig. 2. The power strip contains the AC sockets whose power is controlled, the control relay, and a 12-VAC transformer. The control unit contains the microcontroller and seven functional areas: a ring-detect circuit; LED drivers; a 12-volt power supply; speaker, LED, and parallel-port drivers; and switch and jumper inputs. Note that the control unit has three separate ground circuits: analog for the ring detector, digital for the microcontroller and functional units, and a separate relay ground. All the grounds come together at the power supply. Now let's look at each section of the circuit in more detail.

Detailed circuit description

AC Power Strip Ring-Thing uses a standard AC Power Strip, but modifies the wiring so that the output of the strip's ON/OFF switch also passes through the relay contacts, as shown in Fig.

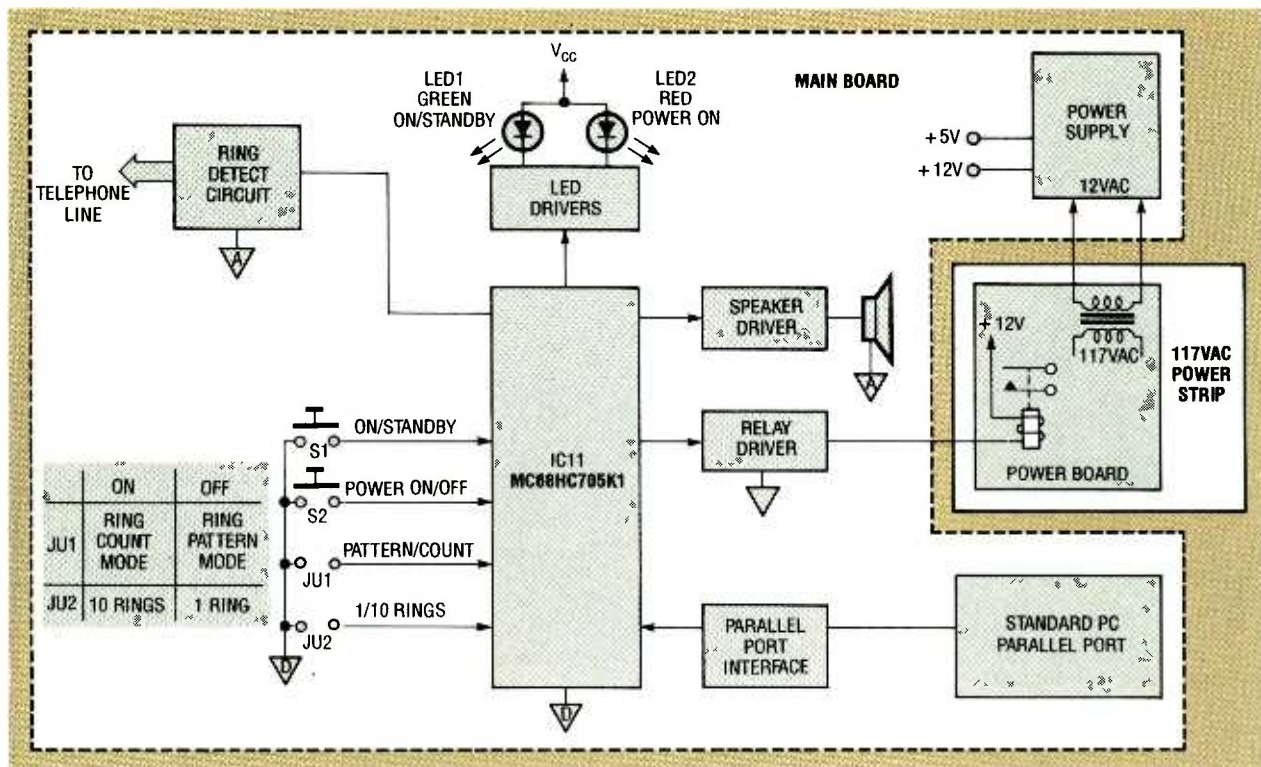

FIG. 2—RING-THING'S INTELLIGENCE is provided by an 8-bit microcontroller, the MC68HC705K1, that reads switch, jumper, and ring-detect inputs, and drives LED's, a speaker, a relay, and (optionally) a parallel-port interface. Note the three separate ground circuits.

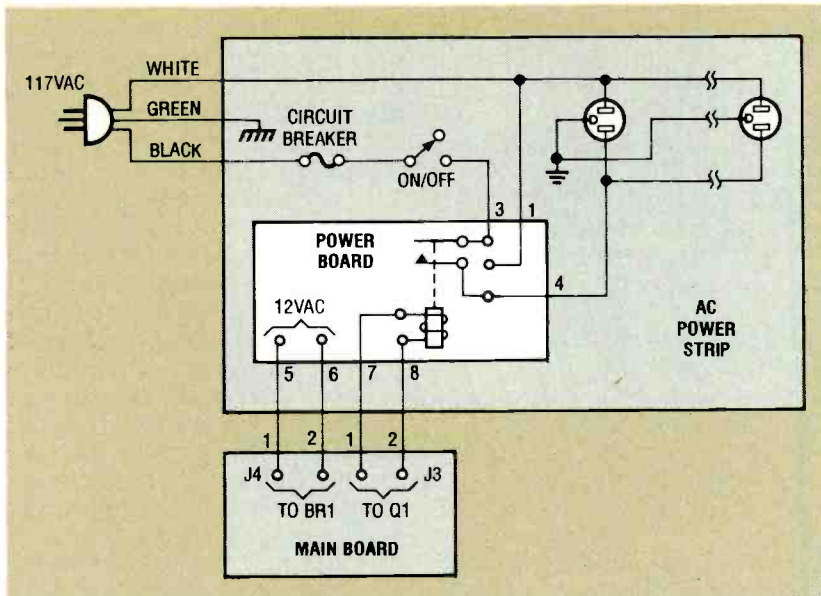

FIG. 3—THE AC POWER STRIP contains a 12-volt transformer and a 12-volt relay mounted on a separate circuit board. Wire the relay's contacts in series with the power strip's on/off switch.

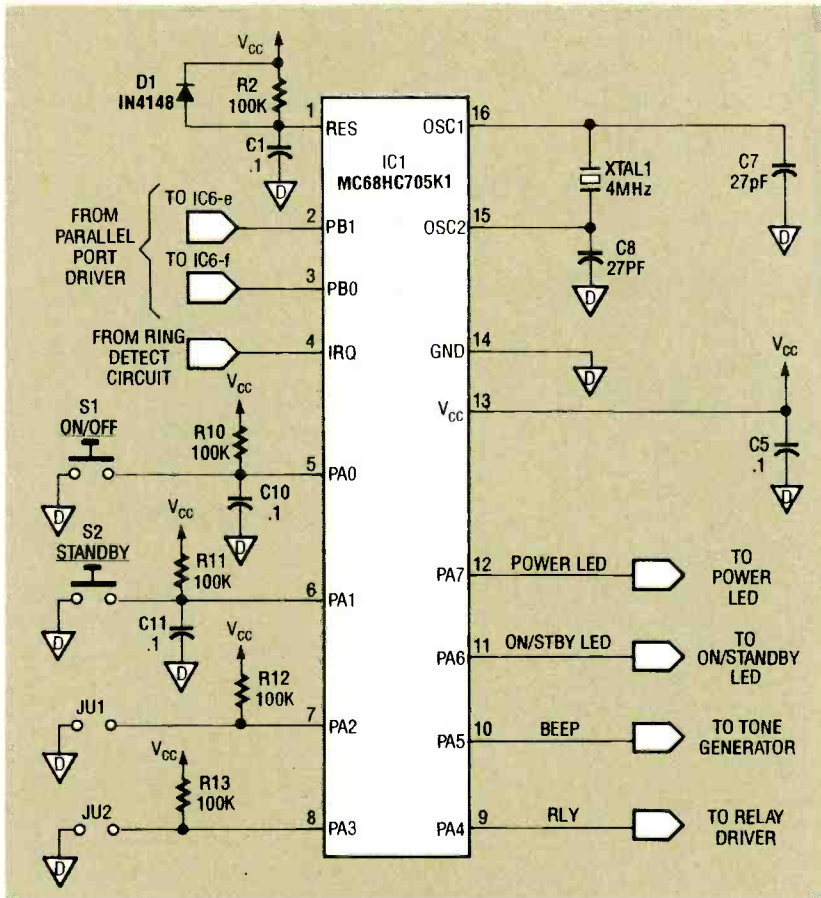

FIG. 4—MICROCONTROLLER AND INPUT SECTIONS of the main circuit board has seven inputs and four outputs.

3. To obtain power from the strip, the switch must be on and the relay must be energized. The power board (including the relay and power transformer) was designed to fit inside the

recommended power strip with little room to spare. There may be interference problems if you use other components.

Microcontroller Ring-Thing's intelligence is provided

POWER BOARD PARTS

RY1—Relay, SPST, 12V Coil, Guardian 1715-1A-12D
 T1—120VAC to 12VAC, 120 mA Transformer, Mouser 41PG120
 PC board, plastic strain reliefs, plastic spacers (#4 × 1/4", 4-40 × 1/2" machine screws with nuts, 14 AWG stranded wire

OPTIONAL PC POWER-DOWN PARTS

IC3, IC4, IC5—PS2502-1 NEC Optoisolator
 D7, D8, D9—1N4148 or 1N914 signal diode
 R16, R18, R19, R20—2200 ohms
 5-conductor cable (22 AWG, 6 feet), DB25 25 Pin Male (Pin) Connector and Hood, control software

ADDITIONAL PARTS NOT SUPPLIED IN KIT

B1—9-volt NiCd battery, Duracell NC1604 or equiv.
 Multi-outlet AC power strip (see text) with 6-amp 3AG fuse and holder

ORDERING INFORMATION

The following parts are available from Digital Products Company, Attn: Thomas E. Black, 134 Windstar Circle, Folsom, CA 95630, 24 hr phone/FAX: (916) 985-7219. Ring-Thing Kit: (All components, programmed microcontroller, enclosure, PC board set, documentation, less PC power-down feature): \$79.95. PC power-down kit (parts, DB25 cable, software): \$9.95. Basic kit (PC board set, microcontroller, transformer, relay, software, documentation): \$59.95. PC board set (#RT001): \$24.95. Programmed MC68HC705K1 microcontroller: \$14.50. Six-outlet metal power strip with fuse kit: \$16.00. Rechargeable battery, 9-volt size, NiCd: \$7.00. Documentation package with schematic: \$4.75. PC software, 5" disk only, includes RT.EXE source: \$7.50. All orders add \$4.50 S&H (\$9.50 to Canada). CA residents add applicable sales tax. U.S. funds only. MasterCard, Visa accepted. Prices subject to change.

by IC1, a low-cost, 8-bit MC68HC705K1 made by Motorola. The microcontroller contains a central processing unit (CPU), as found in your desktop computer. However, it also incorporates 32 bytes of random-access memory (RAM), 504 bytes of read-only memory (ROM), 10 digital input/output lines, timer-based interrupt support, and external-interrupt support. In other words, it's a complete computer housed in a single IC—a 16-pin IC at that!

Of course the microcontroller needs software to operate; software is stored permanently in the internal ROM. Because the

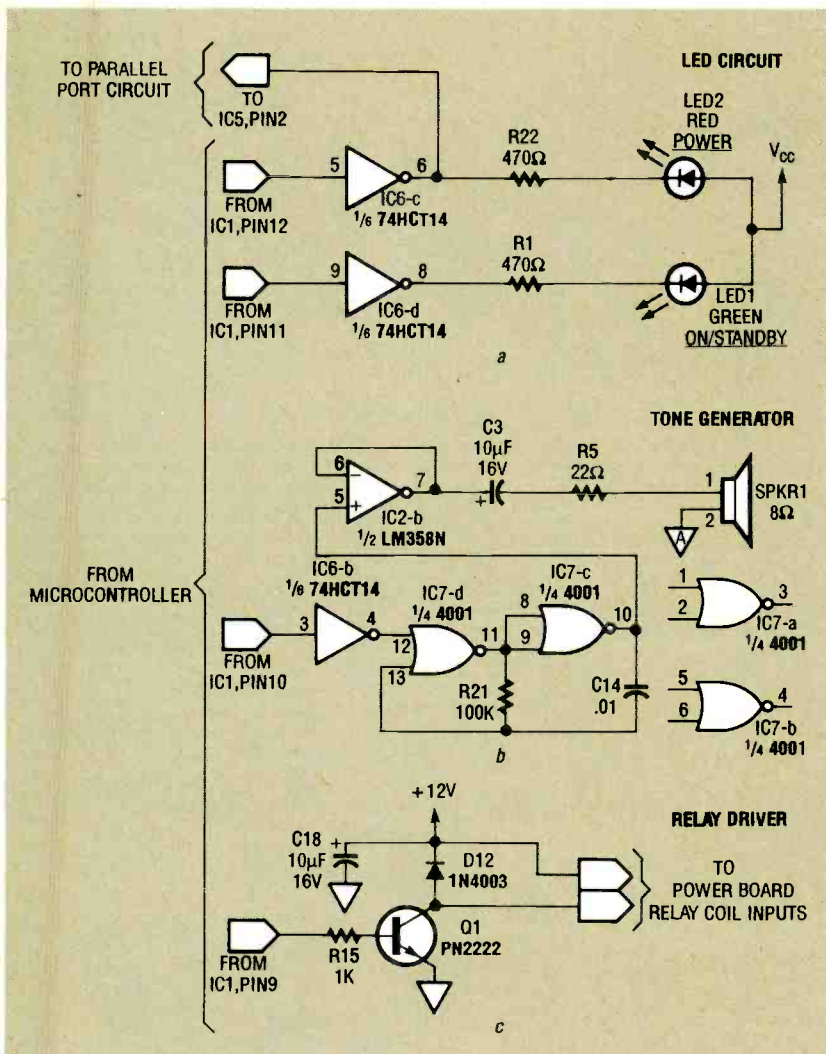

FIG. 5—SEPARATE MICROCONTROLLER OUTPUTS drive the LED (a), tone generator (b), and relay (c) outputs.

TABLE 2—LED STATUS INDICATION

AC power fail	On/Standby and Power-on LED's flashing rapidly
Ring detect on	On/Standby LED on
Phone ringing	On/Standby LED flashing rapidly
Phone line in use	On/Standby LED blinking slowly
Manual AC power	Power-on LED On
Ring invoked power	Power-on LED blinking slowly
AC power timeout	Power-on LED flashing rapidly (two-minute warning).

TABLE 3—RING-THING AUDIBLE ALERTS

Short beep	Power On/Off button pushed
Short modulated beep	On/Standby button pushed
Chirp sound	Phone ringing
Slow beep	AC power auto-turn off (one minute warning)

software is nonvolatile—it remains even when power is removed—it is called *firmware*. The firmware uses all 504 bytes of program ROM to implement a sophisticated real-time operat-

ing system. Major events (e.g., ring detection, tone generation, and LED and relay control) are interrupt driven, so all features work together seamlessly. The firmware uses the timer-based

interrupt to schedule tasks that need to be performed, and the external interrupt to monitor telephone-line activity. The firmware uses RAM for storing temporary data (e.g., current ring count, remaining time, and beep duration). Although there are only 32 bytes of RAM, it's more than enough for our application.

Firmware source code is not available; however, the author has made the object code available in S-record format. It is contained in the file RT.S19, available from the RE-BBS as part of RINGTHING.EXE, and from the author directly, as mentioned in the Parts List. Because a special programmer is required, preprogrammed microcontrollers are available separately (see Parts List).

Figure 4 shows the microcontroller and switch/jumper input sections. Components C1, D1, and R2 provide a power-on reset function for IC1; C7, C8, and XTAL1 provide a steady 4-MHz clock.

Of the ten digital I/O lines, four (PA0–PA3) monitor the switches and configuration jumpers, two (PB0, PB1) monitor the PC's parallel port, and the remainder (PA4–PA7) drive the LED, tone generator, and relay circuits.

The PA0 and PA1 microcontroller inputs monitor the ON/STANDBY and POWER ON/OFF switches (S1 and S2, respectively). Although the switches are momentary-contact, normally-open switches, the software "debounces" them to emulate toggle switches.

The PA2 and PA3 inputs read the condition of JU1 and JU2. If JU1 is installed, then Ring-Thing operates in Ring Counting mode; if JU1 is not installed, then Ring Pattern mode.

If JU1 is installed (i.e., the user selected ring-counting mode), then JU2 determines the number of rings before applying power. If JU2 is installed, Ring-Thing waits 10 rings before answering; if JU2 is not installed, 1 ring.

Now let's look at the output circuits, shown in Fig. 5.

continued on page 85

LAST MONTH WE TALKED ABOUT how the Air Hop system works and went into detail on how optics help increase range. So let's get to work building the system.

Board construction

As you already know, the Air Hop is made from three separate sections, on three separate PC boards. We've provided the foil patterns for the boards in case you want to make your own. The parts-placement diagram for the transmitter board is shown in Fig. 9, the optical amplifier board in Fig. 10, and the FM demodulator board in Fig. 11. In Fig. 10, notice that there are three holes for D1, which allow you to mount the PIN diode facing the front of the board regardless of which PIN diode you use. Also in Fig. 10, as mentioned before, R4 and R5 make up one low-capacitance resistor—solder one lead of each resistor together above the board and mount the other two leads normally. Note that each board has a separate parts list, so be sure to put the right parts on the right board!

Mechanical construction

The physical construction of an optical communications system is just as important as the electrical circuitry. The most obvious problem is keeping the optics in alignment. However, there is another problem with a system that contains a phase-locked loop.

Remember that a phase-locked loop (PLL) contains a voltage-controlled oscillator, or VCO. The PLL compares its VCO with the incoming signal and produces a correction voltage which turns out to be the recovered audio. Even if no signal is being produced by the receiver, the internal oscillator is running and herein lies the problem: If the VCO isn't shielded, or if the power supply isn't properly decoupled, some of the VCO energy can be coupled into the front end of the receiver. That "leakage" signal is amplified by the receiver and is fed back to the phase-locked loop. Because it's the original signal, the loop locks to itself!

LIGHT BEAM COMMUNICATOR

Let's build the Air Hop and put it to use.

RODNEY A. KREUTER

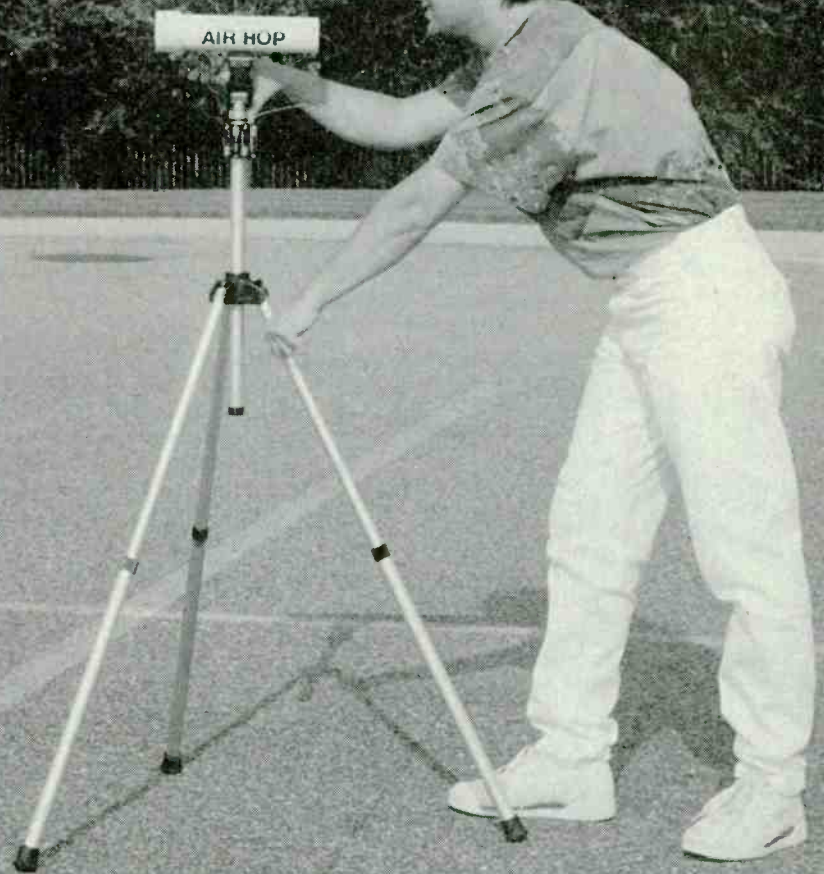

When the input from the receiver exceeds the leakage signal, the loop locks to the real signal and the circuit works

well. However the new signal must be larger than the leakage signal meaning that the receiver could be made more sen-

sitive if the leakage were eliminated.

If you expect to transmit at distances over 1500 feet, the FM demodulator board must be shielded from the optical amplifier board. Some copper-foil covered single-sided PC board material can be used to make a shielded box, or a separate grounded metal box can be used. The prototype has a single-sided PC-board blank mounted on the bottom of the FM demodulator board with the copper side facing away from the underside of the PC board. The shield, which is attached to the demodulator with desoldering-braid straps, also makes an excellent ground plane.

The Air Hop prototype was

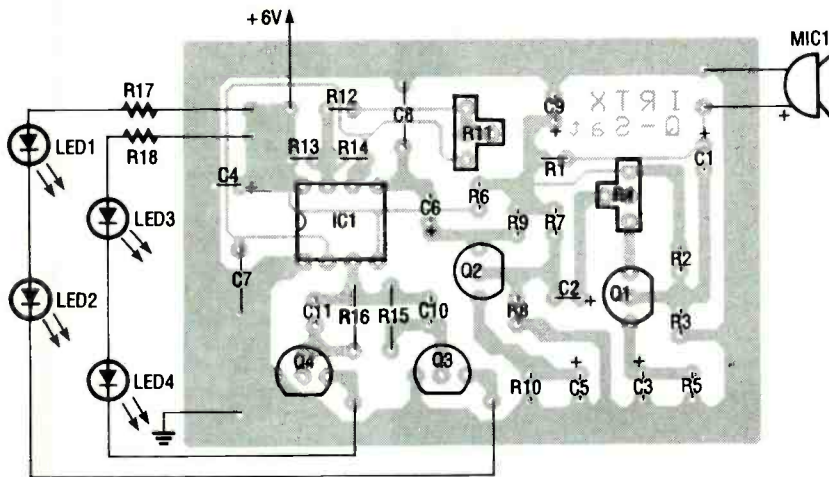

FIG. 9—FM TRANSMITTER parts-placement diagram.

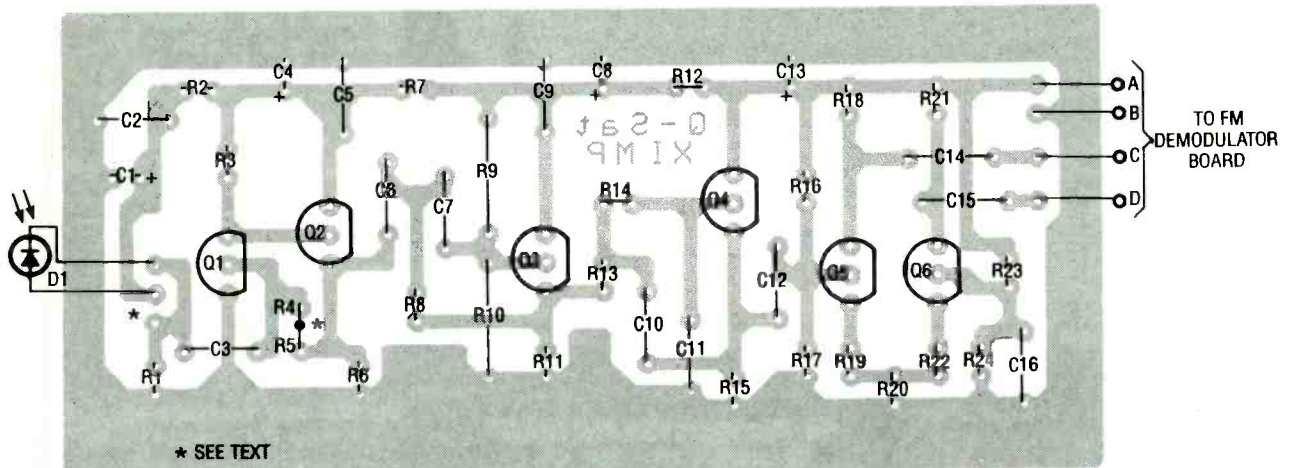

FIG. 10—OPTICAL AMPLIFIER parts-placement diagram. There are three holes for D1 to accommodate different PIN diodes. Resistors R4 and R5 are wired in series and installed as one resistor.

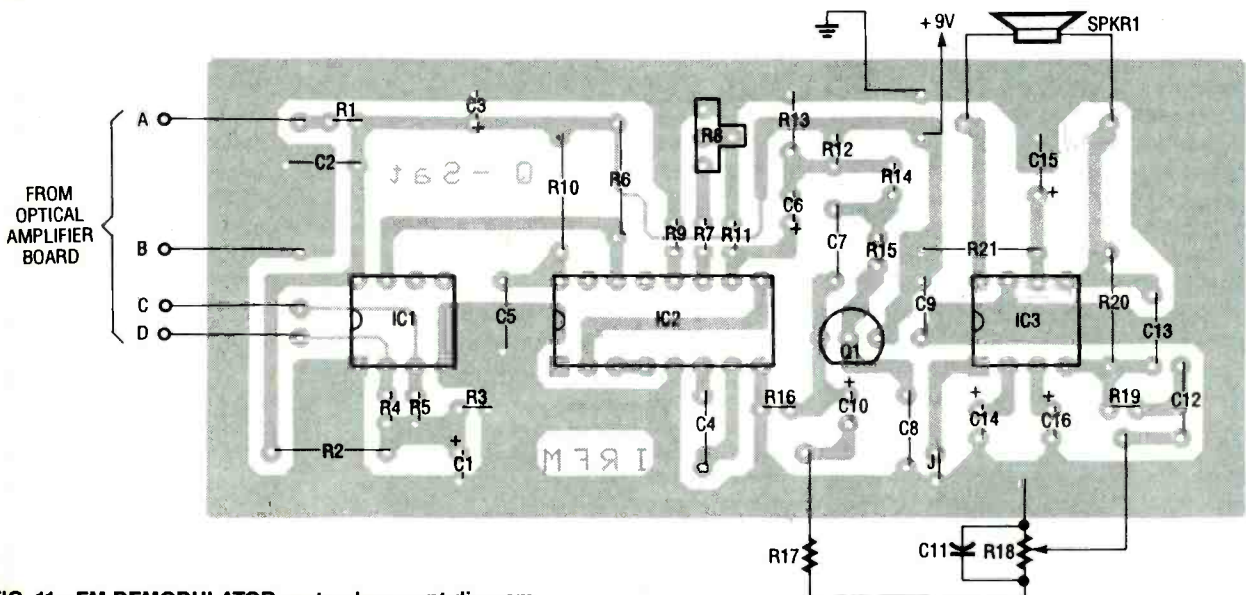

FIG. 11—FM DEMODULATOR parts-placement diagram.

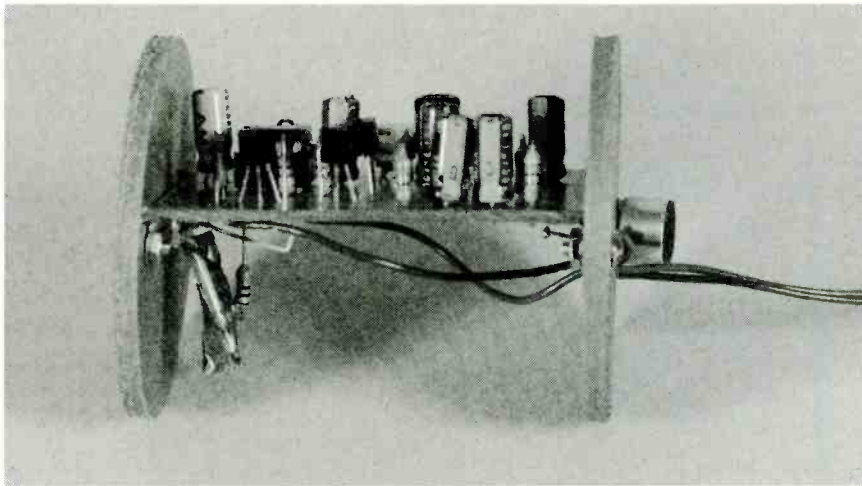

FIG. 12—HERE IS THE TRANSMITTER MODULE mounted on plastic disks that fit inside the PVC pipe.

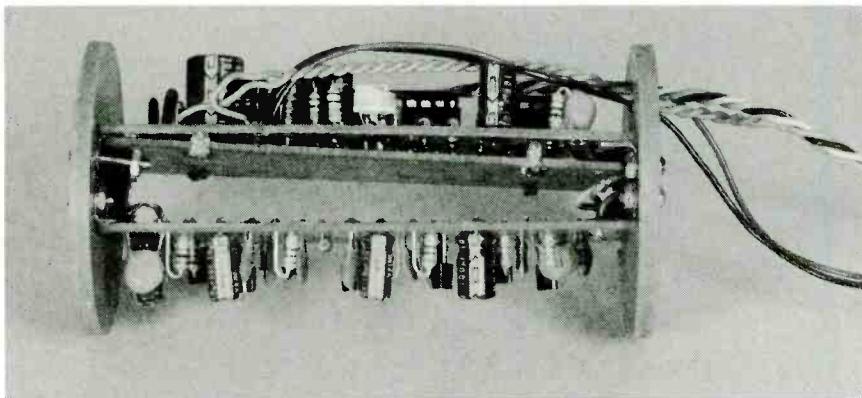

FIG. 13—THE OPTICAL AMPLIFIER and FM demodulator connect together with the shielding board between them, and mount on plastic disks that slide into the PVC pipe.

housed in 2-inch PVC pipe. Pipe couplers were used to mount the two-and-a-half-inch lenses. If you need a three- or even four-inch system, PVC pipe of that diameter is available. The nice thing about PVC is that it's cheap, readily available from hardware and plumbing supply stores, and very strong. Figure 12 shows the transmitter board mounted on plastic disks that fit inside the PVC pipe. Although the demodulator could be mounted outside the pipe, the optical amplifier must be kept close to the detector. The leads from the detector to the amplifier should be less than 1 inch long. The transmitter's LED leads should also be kept short. Figure 13 shows the optical amplifier board and FM demodulator board connected together with the shielding board between them, all ready to slide into the PVC pipe. The optics are focused by sliding the

FM TRANSMITTER PARTS LIST

- All resistors are 1/4-watt, 5%.
- R1, R5, R9, R15, R16—1000 ohms
 - R2—22,000 ohms
 - R3—10,000 ohms
 - R4—1000 ohms, potentiometer
 - R6—100 ohms
 - R7—5600 ohms
 - R8, R13—2200 ohms
 - R10—470 ohms
 - R11—50,000 ohms, potentiometer
 - R12—33,000 ohms
 - R14—15,000 ohms
 - R17, R18—22 ohms (see text)
- Capacitors**
- C1—C3, C6—1 μ F, 16 volts, electrolytic
 - C4—100 μ F, 16 volts, electrolytic
 - C5, C9—10 μ F, 16 volts, electrolytic
 - C7—0.001 μ F, ceramic
 - C8, C10, C11—0.01 μ F, ceramic
- Semiconductors**
- IC1—NE555 timer
 - Q1—Q4—2N3904 NPN transistor
 - LED1—LED4—IR LED (Optek OP293A 880nm, Optek OP295A 880nm narrow beam, Lytron 940nm, see text)
- Other components**
- MIC1—electret microphone
- Miscellaneous:** 4 "AA" batteries and holder, PC board, PVC pipe and plastic disks, hardware, wire, solder, etc.

OPTICAL AMPLIFIER PARTS LIST

- All resistors are 1/4-watt, 5%.
- R1—100,000 ohms
 - R2—10,000 ohms
 - R3, R9, R10, R16, R23—15,000 ohms
 - R4, R5—150,000 ohms
 - R6, R17, R24—3300 ohms
 - R7, R12—100 ohms
 - R8—3900 ohms
 - R13, R14—5600 ohms
 - R11, R15, R18, R21—4700 ohms
 - R19, R22—22 ohms (see text)
 - R20—360 ohms
- Capacitors**
- C1, C4, C8—10 μ F, 16 volts, electrolytic
 - C2, C5, C9—0.1 μ F, ceramic
 - C3, C12, C14—C16—0.01 μ F, ceramic
 - C6, C7, C11—470 pF, ceramic, 10%
 - C10—0.001 μ F, ceramic, 10%
 - C13—100 μ F, 16 volts, electrolytic
- Semiconductors**
- Q1—MPS918 NPN transistor (Motorola)
 - Q2—Q6—2N3904 NPN transistor (Q5 and Q6 must be a matched pair, see text)
 - D1—PIN diode (Siemens SFH205 940nm usable at 880nm, Panasonic PN323BPA 940 nm, Panasonic PN334PA 880 or 940 nm, see text)
- Other components**
- SPKR1—8- to 45-ohm speaker
- Miscellaneous:** PC board, wire, solder, etc.

transmitter and receiver modules in and out of the pipe, changing the distance between the modules and their lenses.

Optics and mechanics

During testing of the Air Hop, a 1-milliwatt transmitter was placed about twenty feet from the receiver and optical tests—such as measuring lens gain and finding focal distances—were performed. Remember that when you align the lenses, you can't see the infrared signal. There's nothing like focusing an image that you can't see! The only way you can tell if the signal is improving is by monitoring either TP1 or TP2; you should see a 50-kilohertz sine wave. The amplitude of the signal is proportional to the received signal strength. Expect tens to hundreds of millivolts. The prototype worked well at power levels of 5 millivolts, peak-to-peak.

You can reduce the optical output of your transmitter for testing by using only one LED and by increasing the value of current limiting resistor R17 or

R18 to a hundred ohms or more. That is necessary because when you run the transmitter at full power from twenty feet, it will saturate the receiver. Saturation will produce a clipped waveform on either TP1 or TP2.

Because the system uses FM, the link will work fine, but it will be hard to tell if optical alignment is obtained when the signal is clipped.

Always try to get the best quality lens. Two dollars today

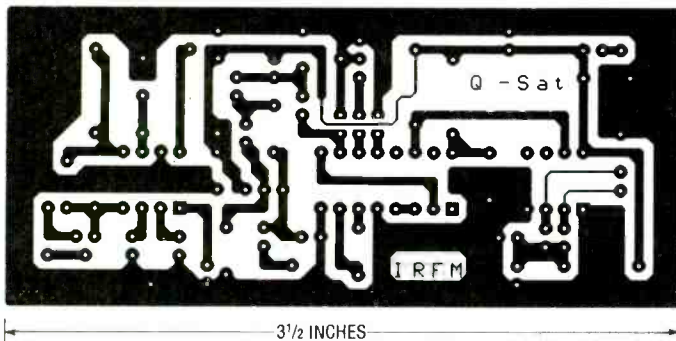

FM DEMODULATOR FOR PATTERN.

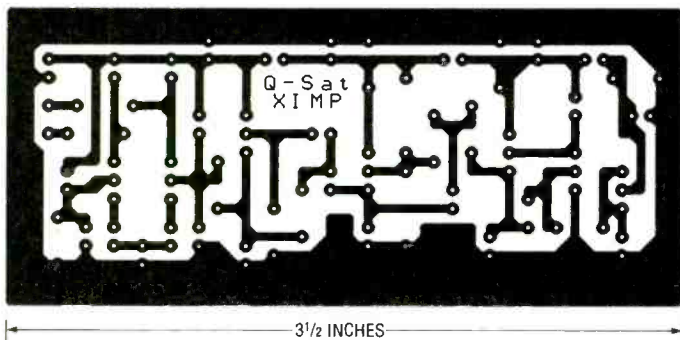

OPTICAL AMPLIFIER FOR PATTERN.

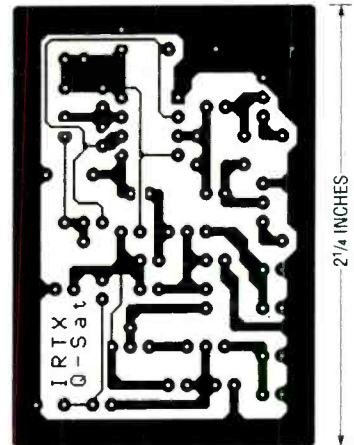

TRANSMITTER FOIL PATTERN.

will buy a piece of plastic that's bent into the shape of a lens—but it should do the job. The focal length of the lens can be found by focusing the sun to a small spot and measuring the distance between the lens and the spot.

Just to prove that you don't get something for nothing, there is a disadvantage in using lenses—beam width. The way the lens works on the transmitter is to gather the light from a diverging source (an LED) and collimate it into a beam. The better the optics, the more collimated the beam. It's a little simpler with the receiver: the receiving lens simply gathers the light from a large area and focuses it on the detector.

Trying to align the transmitter and receiver at a distance of a mile is quite a task, and good tripods are a must. The original Air Hop system had a rifle scope mounted on the transmitter to help locate the receiver. Two-meter handheld radios were also used for communication until the beams were aligned. On the plus side, a tight beam is harder to "tap" than a phone line, if secure communications is what you want.

Using the Air Hop

There are two basic ways to use the Air Hop: with and without optics (lenses). If you wish to cover a broad area and short range, you'll get by without optics. Examples would be a set of wireless headphones, a remote control (such as for a TV), or a computer/printer interface. In

FM DEMODULATOR PARTS LIST

All resistors are 1/4-watt, 5%.

- R1—100 ohms
- R2, R3, R6, R11—R13, R16—10,000 ohms
- R4, R5—100,000 ohms
- R7—33,000 ohms
- R8—50,000 ohms, potentiometer
- R9, R14, R15—68,000 ohms
- R17—4700 ohms
- R18—10,000 ohms, potentiometer
- R19—22,000 ohms
- R20—470,000 ohms
- R21—10 ohms

Capacitors

- C1, C6, C10, C16—1 μ F, 16 volts, electrolytic
- C2, C5, C9, C12—0.1 μ F, ceramic
- C3—100 μ F, 16 volts, electrolytic
- C4, C7—0.001 μ F, ceramic, 10%
- C8—470 pF, ceramic, 10%
- C11—0.01 μ F, ceramic
- C13—100 pF, ceramic
- C14—4.7 μ F, 16 volts, electrolytic
- C15—470 μ F, 16 volts, electrolytic

Semiconductors

- IC1—LM311 or LT1011 comparator
- IC2—CD4046 phase locked loop
- IC3—MC34119 audio amplifier (Motorola)

Q1—2N3904 NPN transistor

Miscellaneous: 9-volt battery and clip,

PC board, blank PC-board material and solder-wick straps for shield (see text), PVC pipe, plastic disks, hardware, wire, solder, etc.

Note: The following items are available from Q-Sat, P.O. Box 110, Boalsburg, PA 16827:

- Complete Air Hop kit including all three PC boards (does not include speaker, 10K volume control, lenses, PVC pipe and batteries), AIRHOP-KIT—\$30.00

- Transmitter kit including one IR LED and PC board, AHTX-KIT—\$11.00

- Transmitter PC board only, AHTX-PCB—\$5.00

- Optical amplifier kit including PIN diode and PC board, AHOPTAMP-KIT—\$12.00

- Optical amplifier PC board only, AHOPTAMP-PCB—\$6.00

- FM demodulator kit including PC board (no speaker or 10K volume control), AHFMDMOD-KIT—\$12.00

- FM demodulator PC board only, AHFMDMOD-PCB—\$6.00

Add \$3.00 shipping and handling to all orders. Pennsylvania residents must add 6% sales tax. Please allow 3 to 4 weeks for delivery.

those cases you can run as many transmit LED's as you choose. The basic system is set up to accommodate from one to four LED's. Four LED's with relatively large beam angles will flood a room with IR.

If you want to achieve great distances, a system with optics is the only choice. Unfortunately, it's impossible to couple two or more LED's into a single lens. A lens has a small focal point, and one LED properly focused is the best you can get from a single lens.

Calculating distance

In central Pennsylvania where the author lives, it's hard to find a straight stretch of road longer than about a half mile. (Roads are good for testing because the distance can be measured by using the odometer in your car or bike.) When the original Air Hop was tested in southwestern Virginia, short-distance ranges were set up along a road. Long-distance ranges were set up from mountaintop to mountaintop and measured with topographical maps.

There is a way to calculate how far your system will work without using a long optical path. The transmitter must be fitted with its collimating lens and adjusted for best performance because the lens-gain equations work only for the receiving optics. No lens should be used on the receiver for this test.

Set up your transmitter and receiver a reasonable distance apart—say 100 feet. Adjust the transmit optics for the best signal, and then move the receiver back until the signal gets a little noisy. (This experiment can occupy the best part of a day because the physical alignment must be performed each time you move the receiver.) If you obtain a distance of 250 feet, and were to add a three-inch lens with a gain of 24.5 to the receiver, the usable distance would be 6125 feet.

Variations

The bandwidth can be increased by increasing the car-

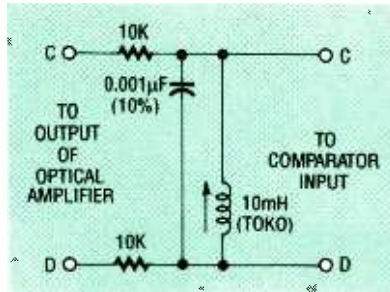

FIG. 14—THIS LC FILTER, placed between the output of the optical amplifier and the FM demodulator, can increase the usable distance by decreasing the bandwidth.

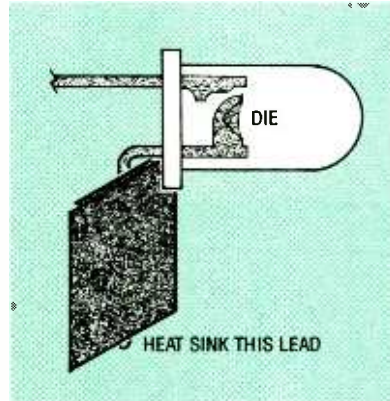

FIG. 15—AN LED'S EFFICIENCY falls with temperature. You can heat sink an LED by soldering some heavy copper foil to the LED's cathode lead upon which the die is mounted.

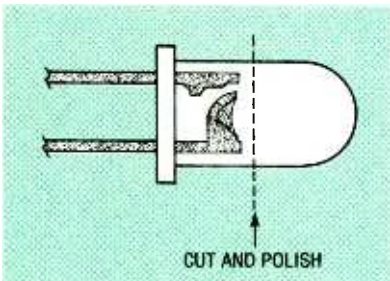

FIG. 16—YOU CAN REMOVE AN LED's lens by cutting off its end and polishing the exposed surface.

rier frequency of the Air Hop. Of course, that would mean redesigning all of the filters in the system. A carrier of about 150 kilohertz should yield 15 kilohertz of audio bandwidth.

A simple LC filter placed between the output of the optical amplifier and the FM demodulator can increase the usable distance by decreasing the bandwidth. Such a filter is shown in Fig. 14. The series resistors control the overall filter width. An increase in resistance will cause a decrease in band-

width. Values from 3.3K to 33K should work well. The filter should be tuned while the link is operating. Simply monitor either side of the LC tank with a scope, and tune for maximum voltage.

A parabolic mirror would be a better collimator for the LED than a lens. Consider a simple flashlight reflector or the kinds of flashlights with focusing lenses.

The efficiency of an LED falls with temperature, so keeping the LED cool will help. As a matter of fact, that's one of the major reasons why the author lost the original Air Hop competition. His opponent attached a heat sink to his LED by soldering some heavy copper foil to the LED's cathode lead, the lead on which the die is mounted. If you look closely inside an LED, you will see that one of the lead ends is larger than the other and is bent 90 degrees. That lead carries the heat out of the junction (see Fig. 15).

It has been suggested that LED's with no internal lens are the best choice when coupling into an external lens. The lens top can easily be cut off a standard LED for experimentation as shown in Fig. 16.

Semiconductor lasers are now selling for less than thirty dollars in small quantities. One would probably vastly improve the Air Hop.

Most of the optical experiments were done with visible-light LED's, recognizing that the difference in using infrared LED's would be minor. For example, it was hard to collimate the infrared beam without being able to see it. By mounting four red LED's around the infrared LED, the collimation of the four red units was visible. Because the IR LED was in the middle of the red units, it could also be aimed.

Even though the winning contestant had "cheated" by heatsinking an LED and running it at five times the rated current, the author would like to thank Gene Wood for challenging him to the original Air Hop contest—otherwise this project would not exist. R-E

1992

ANNUAL INDEX

Electronics NOW® Volume 63

1992 Annual Index Electronics Now, Volume 63

Abbreviations: (ARE)Ask R-E; (AUD)Audio Update, (C)Construction; (CC)Computer Connections; (D)Department; (DB)Drawing Board; (ED)Editorial; (ER)Equipment Reports; (HH)Hardware Hacker; (LTR)Letters; (QA)Q&A; (VN)Video News; (WN)What's News

250-Watt Power Inverter (Melton)(C) Oct 75
10 50-ohm Termination (QA) Dec 12
555
Oscillators (Marston) Nov 61
A Versatile Oscillator (Marston) Oct 69
A Versatile Timer (Marston) Sep 58
60-Hz Hum (ARE) Jun 12,(LET) Sep 16

A

ADC for your PC, Experimenting with (Barbarelo)(C) Jan 59, Feb 65,(LET) Mar 14
AES: Audio Fact and Fantasy (Klein)(AUD) Mar 80

AM
Stereo, Syndicated Reviewers, and Consumer Fraud (Klein)(AUD) Oct 78
Tries for a Comeback (Feldman) Feb 48
Adobe Type Manager (Holtzman)(CC) Mar 90

Air Hop
The Light Beam Communicator (Kreuter)(C) Dec 51

AMATEUR TV
ATV Downconverter (Sheets and Graf)(C) Sep 79
ATV Linear Amp (Graf and Sheets)(C) Aug 67

Alternate Action Latches (Lancaster)(HH) Oct 79
Allimeter, Digital (Caristi)(C) May 50

AMPLIFIERS
Classic Video Revisited (Perez) Jun 57
Composite Audio Power (Kitchin)(C) Nov 38

Analog Switch Loss (ARE) Jun 12
Antenna, Sloping Vee (Formato)(C) Sep 71
Apple Family, The (QA) Sep 12

Apple's PhotoGrade (Lancaster)(HH) Sep 85
ASK R-E (D) Jan 12, Feb 12, Mar 12, Apr 12, May 12, Jun 12, Jul 10, Aug 14

AUDIC (SEE ALSO AUDIO UPDATE, RADIO)
Amp for your Car, Build this
High-Power (Metz and Boyce)(C) Apr 31

FM Stereo Broadcaster (Stroud)(C) Jul 33
Handi-Talkie (Wray)(C) Oct 35
MIDI Interface for your PC (Simonton)(C) Mar 33

Composite Audio Power Amplifiers (Kitchin)(C) Nov 38
Crosstalk (QA) Oct 12
Light (ARE) Jan 12

Sloping Vee Antenna (Formato)(C) Sep 71
VFX Digital Signal Processor (Borax and Beck)(C) Sep 37

AUDIO ENGINEERING SOCIETY CONVENTION
AES: Audio Fact and Fantasy (Klein)(AUD) Mar 80
Let's Phase the Music: More from the AES Convention (Klein)(AUD) May 73

Testing the Testers (Klein)(AUD) Jun 76
AUDIO UPDATE (Klein)(D) Jan 73, Feb 85, Mar 80, Apr 70, May 73, Jun 76, Jul 82, Sep 92, Oct 78, Nov 78, Dec 94

AES: Audio Fact and Fantasy
Audio Evaluations:
A Non-Mystical Approach Nov 78
Format Future Shock Sep 92

Hear Today, Gone Tomorrow Apr 70
It's a Matter of Hear Today, Gone Tomorrow Dec 94

Kit Era Passes:
Heath Pulls the Plug Jul 82
Let's Phase the Music:
More from the AES Convention May 73

More from the Mail Bag Feb 85
Reader Questions: Real and Imagined.
Serious and Silly Jan 73
Syndicated Reviewers, AM Stereo, and Consumer Fraud Oct 78
Testing the Testers Jun 76

Automatic Voltage Sensing (ARE) Aug 14

AUTOMOTIVE
Build A Power Controller for Automotive Accessories (Sweeney)(C) Nov 57
Build This High Power Audio Amp for your Car (Metz and Boyce)(C) Apr 31
Car Battery Tester (Fox)(C) Jul 57
Regulators, Back to, and Forward to our Oscilloscope (Grossblatt)(DB) May 82
Voltage Regulators, More on (Grossblatt)(DB) Jan 75

B

Back to Automotive Regulators and Forward to our Oscilloscope (Grossblatt)(DB) May 82
Battery Tester, Car (Fox)(C) Jul 57

Beckman Industrial
DM10XL Digital Multimeter (ER) Sep 22
HD160 Digital Multimeter (ER) Dec 16

Breadboarding
JPC International TD107 Digital Designer (ER) Nov 22

BUILD A THE THIS
FM Stereo Broadcaster (Stroud)(C) Jul 33
Handi-Talkie (Wray)(C) Oct 35

High Power Audio Amp for your Car (Metz and Boyce)(C) Apr 31
Hyper Clock (Schmidt)(C) Feb 33

Microprocessor Development System (Dage)(C) Apr 57, May 57
MIDI Interface for your PC (Simonton)(C) Mar 33

Polapulse Recycler (Spiwak)(C) May 64
Power Controller for Automotive Accessories (Sweeney)(C) Nov 57
Reflex Timer (Kennedy)(C) Oct 43

Robot Bug (Sonntag and Chaney)(C) Jun 33
Snooper Stopper (Wolf)(C) Apr 37
Snapper Strobe (Simonton and Simonton)(C) Nov 31

Buyer's Guide to DMM's (Prentiss) May 31

C

CD-I (Holtzman)(CC) Dec 97
CD-ROM Science and Technical Reference Set, McGraw-Hill (ER) Jan 22

CD-to-Car-Radio Adapters (Lancaster)(HH) Jun 69
CDTV (Holtzman)(CC) Dec 97

CET EXAM
March 10: Electronics Technicians Day (Steckler) Mar 16

CABLE TV
Infamous Bullet (Foley) Jan 33
Build The Snooper Stopper (Wolf)(C) Apr 37

Call-Waiting Dilemma (ARE) May 12
Caller-ID
Circuit (Lancaster)(HH) Mar 73
Update (Lancaster)(HH) Feb 77

Capacitance Meter PC-Based Test Bench (Wolfe)(C) Jul 41
Car Battery Tester (Fox)(C) Jul 57

Checker Computer-Monitor Tester, The (ER) Oct 16
Cheshire Cat, Multimedia, and Vision, The (Holtzman)(CC) Sep 97

Christmas Ornament Glimmer Globe (Holzwarth)(C) Dec 35
Classic Video Amps Revisited (Perez) Jun 57,(LET) Oct 14

Colorado Memory Systems Jumbo 250 (Holtzman)(CC) Sep 97

Commercial Limiter (ARE) Jan 12,(LET) May 16
Communicator, Light Beam (Kreuter)(C) Dec 51
Composite Audio Power Amplifiers (Kitchin)(C) Nov 38

CompuScope Lite PC Oscilloscope Gage Applied Science (ER) Aug 22

COMPUTER (SEE ALSO COMPUTER CONNECTION, MULTIMEDIA)
ADC for your PC, Experimenting with (Barbarelo)(C) Jan 59, Feb 65

Apple Family, The (QA) Sep 12
Apple's PhotoGrade (Lancaster)(HH) Sep 85
Build This
Microprocessor Development System (Dage)(C) Apr 57, May 57

MIDI Interface for your PC (Simonton)(C) Mar 33
CrossTalk for Windows 1.2 (Holtzman)(CC) Mar 90

Dallas Semiconductor Touch Memory Starter Kit (ER) Mar 24
Designer 3.1 (Holtzman)(CC) Mar 90

Experimenting with ADC for your PC (Barbarelo)(C) Jan 59, Feb 65,(LET) Mar 14
From Not-Working to Networking (McClellan) Aug 55, Sep 53, Oct 65

Gage Applied Science CompuScope Lite PC Oscilloscope (ER) Aug 22
Global Specialties Photolab Release 3.0 (ER) Apr 24

Grid Pad RF Pen-Based PC (Holtzman)(CC) Feb 91

Hard-Disk Standards, The Inside Story on (Miller) Jun 63
IBM OS/2 (Holtzman)(CC) Aug 80

IBM OS/2 2.0 (Holtzman)(CC) Apr 80
iWorks, NTSC (Holtzman)(CC) Nov 88
Lantastic 4.0 (Holtzman)(CC) Mar 90

Laser Printer Repairs (Lancaster)(HH) Apr 63
Local Bus (QA) Oct 12
Locked-Up Computer (QA) Nov 12

MIDI
Interface for your PC (Simonton)(C) Mar 33,(LET) Jul 12
Light Controller (Keefe)(C) May 41

McGraw-Hill CD-ROM Science and Technical Reference Set (ER) Jan 22
Microprocessor Development System (Dage)(C) Apr 57, May 57

Microsoft
Excel 4.0 (Holtzman)(CC) Aug 80
TrueType (Holtzman)(CC) Jun 84

Windows 3.1 (Holtzman)(CC) Jun 84
Word for Windows 2.0 (Holtzman)(CC) Mar 90

Monitors (Lancaster)(HH) Jan 67
Monitor Technology (Warner) Dec 69
-Monitor Tester, The Checker (ER) Oct 16

Monitor Technology (Warner) Dec 69
Tester (Price)(C) Jan 47,(LET) Jun 14

OS:2 2.0 and Windows 3.1 (Holtzman)(CC) Jun 84
IBM (Holtzman)(CC) Apr 80

PC
Password Protection (Hatten)(C) Jul 51
-Based Test Bench (Wolfe)(C) Jun 39, Jul 41, Aug 60, Oct 47
Speed Limit (ARE) Feb 12

PageAhead Software, InfoPublisher (Holtzman)(CC) Nov 88
Paper Software's SideBar (Holtzman)(CC) Jan 84
Paragon Engineering LA16PC Logic Analyzer (ER) Jul 21

SideBar, Paper Software's (Holtzman)(CC) Jan 84
 Speeding Cursor (QA) Sep 12
 Sytron Corp. Sytron Plus (Holtzman)(CC) Sep 97
 TrueType, Microsoft (Holtzman)(CC) Jun 84
 VGA Adapter for the Mac LC (Lancaster)(HH) Jan 67

COMPUTER CONNECTIONS (Holtzman)(D)Jan 84, Feb 91, Mar 90

Apr 80, May 75, Jun 84
 Jul 90, Aug 80, Sep 97
 Oct 91, Nov 88, Dec 97
 Cheshire Cat, Multimedia, and Vision Computers and Consumer Electronics Gigabyte Memory Storage Industry Evolution Miniature Multimedia Machines Multimedia Mayhem Pen-Based Computing Personal Digital Assistant, The Russian Dolls and the Virtual PC User Manifesto, A Will You OS/2 it? Windows 3.1, OS/2 2.0

CONSTRUCTION

250-Watt Power Inverter (Melton) Oct 75
 ATV
 Downconverter (Sheets and Graf) Sep 79
 Linear Amp (Graf and Sheets) Aug 67
 Build
 A Power Controller for Automotive Accessories (Sweeney) Nov 57
 the Hyper Clock (Schmidt) Feb 33
 The Polapulse Recycler (Sowiak) May 64
 The Snooper Stopper (Wolf) Apr 37
 This FM Stereo Broadcaster (Stroud) Jul 33
 This Handi-Talkie (Wray) Oct 35
 This High Power Audio Amp for your Car (Metz and Boyce) Apr 31
 This Microprocessor Development System (Dage) Apr 57, May 57
 This MIDI Interface for your PC (Simonton) Mar 33
 This Reflex Timer (Kennedy) Oct 43
 This Robot Bug (Sonntag and Chaney) Jun 33
 This Super Strobe (Simonton and Simonton) Nov 31

Car Battery Tester (Fox) Jul 57
 Composite Audio Power Amplifiers (Kitchin) Nov 38
 Digital Altimeter (Caristi) May 50, (LET) Oct 14
 Electronic Thermostat (Kreuter) Jun 53
 Experimenting with ADC for your PC (Barbarelio) Jan 59, Feb 65, (LET) Mar 14
 Fax/Modem Protector (Petruzzellis) Dec 43
 Glitter Globe (Holzwarth) Dec 35
 Inrush Current Limiter (Wirth) Dec 47
 Intelligent Phone-Line Monitor (Black) Mar 53, Apr 52
 Light Beam Communicator (Kreuter) Dec 51
 MIDI Light Controller (Keefe) May 41
 Monitor Tester (Price) Jan 47
 PC Password Protection (Hatten) Jul 51
 PC-Based Test Bench (Wolfe) Jun 39, Jul 41, Aug 60, Oct 47
 Remote Control for your Dog (Canino) Apr 47
 Scanner Converter (Sheets and Graf) Feb 42, Mar 41
 Single-Chip Messaging System (Tenney) Mar 59
 Sloping Vee Antenna (Formato) Sep 71
 Solid-State Relay (Kreuter) May 47
 Speaker Mate (Plant) Jan 43
 Surf Man (Simonton) Aug 33
 Sweep Function Generator (Lashansky) Jan 35, Feb 53
 Telephone Hold Button (Green) Nov 45
 Scrambler (Rosenmayer) Aug 37
 Universal Remote Control (Eady) Nov 47
 VFX Digital Signal Processor (Borax and Beck) Sep 37

Consultants Network (Lancaster)(HH) Sep 85
 Consumer Fraud, Syndicated Reviewers, AM Stereo and (Klein)(AUD) Oct 78
 Continuity Checker, 555-Based (Marston) Nov 61
 Conventional Currents (Lancaster)(HH) Dec 77
 Correlation Fundamentals (Lancaster)(HH) Aug 72
 CrossTalk for Windows 1.2 (Holtzman)(CC) Mar 90
 Crystal Oscillator (QA) Dec 12

D

DMMs, Buyer's Guide to (Prentiss) May 31
 Dallas Semiconductor Touch Memory Starter Kit (ER) Mar 24
 Descrambler, SSAVI Let's Get Back To Our (Grossblatt)(DB) Dec 88
 Descrambling a SSAVI Signal Let's See What's Involved in (Grossblatt)(DB) Oct 88
 Designer 3.1 (Holtzman)(CC) Mar 90
 Differential Probe (Dorfman) Oct 61
 Digi-Call Intelligent Phone-Line Monitor (Black)(C) Apr 52

DIGITAL

Altimeter (Caristi)(C) May 50, (LET) Oct 14
 Designer, JPC International TD107 (ER) Nov 22
 Image Processing (Lancaster)(HH) Oct 79
 Logic IC Tester, T1004 PC-Based Test Bench (Wolfe)(C) Oct 47
 Multimeter

Beckman Industrial DM10XL (ER) Sep 22
 HD160 (ER) Dec 16
 Kelvin 100K (ER) Feb 16
 Scopes, Our Long-Lost Discussion on (Grossblatt)(DB) Feb 88
 Signal Processor, VFX (Borax and Beck)(C) Sep 37
 Tachometer Trouble (QA) Nov 12
 Direct Toner (Lancaster)(HH) Aug 72
 Distant FM Reception (Lancaster)(HH) Nov 68
 Double- and High-Density Disks (QA) Sep 12, (LET) Dec 14
 Downconverter, ATV (Sheets and Graf)(C) Sep 79
 DRAWING BOARD (Grossblatt)(D) Jan 75, Feb 88, Mar 82

Apr 72, May 82, Jul 88, Aug 27
 Sep 95, Oct 88, Nov 84, Dec 88
 Back to Automotive Regulators and Forward to our Oscilloscope May 82
 Let's Add the Final Touches to Our Oscilloscope Jul 88
 Build Our Own Video Scrambler! Nov 84
 Explore the Mysteries of Video Scrambling Aug 27
 Get Back To Our SSAVI Descrambler Dec 88
 See What's Involved in Descrambling a SSAVI Signal Oct 88
 Work on the Vertical Section of our Scope Apr 72
 More on Automotive Voltage Regulators Jan 75
 Our Long-Lost Discussion on Digital Scopes Feb 88
 Oscilloscope is Shaping Up Nicely Mar 82
 Video Scrambling Sep 95
 Driveway Alarm (ARE) May 12
 Dycam Digital Camera (Holtzman)(CC) May 75
 Dye-Based Solar Energy (Lancaster)(HH) Jul 75

E

EGA-VGA Adapter (ARE) Mar 12
 EDITORIAL (Steckler)(D) Jul 4, Aug 4, Sep 4, Oct 4, Nov 4, Dec 4
 Everything Changes It's Now or Never Now's the Time Sep 4, Oct 4

ELECTRONIC

Dice (ARE) Apr 12, (LET) Jul 12
 Halftones (Lancaster)(HH) Sep 85
 Technicians Day: March 10 (Steckler) Mar 16
 Temperature Measurement (Trinettey) Mar 46, Apr 40
 Thermostat (Kreuter)(C) Jun 53

EQUIPMENT REPORTS (D)

Jan 22, Feb 16, Mar 24, Apr 24, Jun 16, Jul 21, Aug 22
 Sep 22, Oct 16, Nov 22, Dec 16
 Beckman Industrial DM10XL Digital Multimeter Sep 22
 HD160 Digital Multimeter Dec 16
 Checker Computer-Monitor Tester Oct 16
 Dallas Semiconductor Touch Memory Starter Kit Mar 24
 Gage Applied Science CompuScope Lite PC Oscilloscope Aug 22
 Global Specialties Photolab Release 3.0 Apr 24
 JPC International TD107 Digital Designer Nov 22
 Kelvin 100K Digital Multimeter Feb 16
 McGraw-Hill CD-ROM Science and Technical Reference Set Jan 22
 Multidyne TS-8-MTS TV Test-Signal Generator Jul 16
 Paragon Engineering LA16PC Logic Analyzer Jul 21
 Everything Changes (Steckler)(ED) Jul 4, Aug 4 Experimenting with ADC for your PC (Barbarelio)(C) Jan 59, Feb 65, (LET) Mar 14

F

FM Antenna (ARE) Jun 12
 Antenna Range Contest (Lancaster)(HH) Aug 72
 Stereo Broadcaster, Build This (Stroud)(C) Jul 33
 Broadcasters (Lancaster)(HH) Jun 69
 Transceiver, The Handi-Talkie (Wray)(C) Oct 35
 Yagi Antenna Design (Lancaster)(HH) Dec 77
 Fax/Modem Protector (Petruzzellis)(C) Dec 43
 Flyback Deflection (Lancaster)(HH) Jan 87
 Format Future Shock (Klein)(AUD) Sep 92
 Frequency Counter PC-Based Test Bench (Wolfe)(C) Jul 41
 From Not-Working to Networking (McClellan) Aug 55, Sep 53, Oct 65, (LET) Nov 16
 Freeze Frame Super Strobe (Simonton and Simonton)(C) Nov 31
 Fuse Substitutions (ARE) Apr 12
GPS NAVIGATION Resources (Lancaster)(HH) Jan 67
 Update (Lancaster)(HH) Apr 63
 Gage Applied Science CompuScope Lite PC Oscilloscope (ER) Aug 22, (LET) Oct 14
 Gamma Curve Correction (Lancaster)(HH) Oct 79
 Gigabyte Memory Storage (Holtzman)(CC) Nov 88
 Glitter Globe (Holzwarth)(C) Dec 35
 Global Specialties Photolab

Release 3.0 (ER) Apr 24
 GRID GridPad RF Pen-Based PC (Holtzman)(CC) Feb 91

H

Hacking Super Nintendo (Lancaster)(HH) Apr 63
 Handi-Talkie, Build This (Wray)(C) Oct 35
 Hard-Disk Standards, The Inside Story on (Miller) Jun 63
 Hard-Drive LED (ARE) Jul 10
HARDWARE (SEE COMPUTER)
HARDWARE HACKER (Lancaster)(D) Jan 67, Feb 77, Mar 73
 Apr 63, Jun 69, Jul 75, Aug 63
 Sep 85, Oct 79, Nov 68, Dec 77
 Apple's PhotoGrade Caller ID Update Sep 85
 Conventional Currents Distant FM Reception Jul 75
 Dye-Based Solar Energy Histogram Equalization Oct 79
 Laser Printer Repairs Santa Claus Machine BBS Super Nintendo Update Aug 72
 Using the IC Master VGA Adapter for the Mac LC Mar 73
 Jan 67
 Hear Today, Gone Tomorrow (Klein)(AUD) Apr 70
 Heath Pulls the Plug: The Kit Era Passes (Klein)(Aud) Jul 82
 Histogram Equalization (Lancaster)(HH) Oct 79
 Hold Button, Telephone (Green)(C) Nov 45
 Hyper Clock, Build the (Schmidt)(C) Feb 33

I

IBM Video Scan Rates (QA) Dec 12
 10 IC Master, Using the (Lancaster)(HH) Mar 73
 IS CET March 10: Electronics Technicians ay (Steckler) Mar 16
 Industry Evolution (Holtzman)(CC) Mar 90
 Inrush Current Limiter (Wirth)(C) Dec 47
 Inside Story on Hard-Disk Standards, The (Miller) Jun 63
 Intelligent Phone-Line Monitor (Black)(C) Mar 53, Apr 52
 It's a Matter of Hear Today, Gone Tomorrow (Klein)(AUD) Dec 49
 It's Now or Never (Steckler)(ED) Nov 4, Dec 4
 ItWorks, NTSC (Holtzman)(CC) Nov 88

J

JPC International TD107 Digital Designer (ER) Nov 22

K

Kelvin 100K Digital Multimeter (ER) Feb 16
 Kit Era Passes: Heath Pulls the Plug (Klein)(Aud) Jul 82

L

LED Display Drivers, Working with (Marston) Mar 65, May 65
 LEDs, Working with (Marston) Jan 50, Feb 69
 Lantastic 4.0 (Holtzman)(CC) Mar 90
 Laser Printer Repairs (Lancaster)(HH) Apr 63
 Let's Add the Final Touches to Our Oscilloscope (Grossblatt)(DB) Jul 88
 Build Our Own Video Scrambler! (Grossblatt)(DB) Nov 84
 Explore the Mysteries of Video Scrambling (Grossblatt)(DB) Aug 27
 Get Back To Our SSAVI descrambler (Grossblatt)(DB) Dec 88
 Phase the Music: More from the AES Convention (Klein)(AUD) May 73
 See What's Involved in Descrambling a SSAVI Signal (Grossblatt)(DB) Oct 88
 Work on the Vertical Section of our Scope (Grossblatt)(DB) Apr 72

LETTERS (D)

Jan 14, Feb 14, Mar 14, Apr 16
 May 16, Jun 14, Jul 12, Aug 20
 Sep 16, Oct 14, Nov 16, Dec 14
LIGHT Alarms, 555 Oscillators (Marston) Nov 61
 Beam Communicator (Kreuter)(C) Dec 51
 Controller, MIDI (Keefe)(C) May 41
 Linear Amp, ATV (Graf and Sheets)(C) Aug 67
 Line-Level Difference (QA) Oct 12
 Local Area Networks From Not-Working to Networking (McClellan) Aug 55, Sep 53, Oct 65
 Local Bus (QA) Oct 12
 Locked-Up Computer (QA) Nov 12

Logic Analyzer, Paragon Engineering LA16PC (ER) Jul 21
 Lots of Switching Q&A (QA) Nov 12
 Lumeloid and Lepcon Films (Lancaster)(HH) Feb 77

M

MIDI
 Interface for your PC (Simonton)(C) Mar 33,(LET)Jul 12
 Light Controller (Keele)(C) May 41
 MTS Stereo (QA) Dec 12
 March 10: Electronics Technicians Day (Steckler) Mar 16
 Marketing Your Ideas (Lancaster)(HH) Sep 85
 McGraw-Hill CD-ROM Science and Technical Reference Set (ER) Jan 22
 Measuring Real Power (Lancaster)(HH) Feb 77
 Messaging System, Single Chip (Tenney)(C) Mar 59
 Metronome, 555-Based (Marston) Nov 61
 Micro-Avionics Newsletters (Lancaster)(HH) Jul 75
 Microprocessor Development System (Dage)(C) Apr 57,May 57

Microsoft
 Excel 4.0 (Holtzman)(CC) Aug 80
 TrueType (Holtzman)(CC) Jun 84
 Windows 3.1 (Holtzman)(CC) Jun 84
 Word for Windows 2.0 (Holtzman)(CC) Mar 90
 Miniature Multimedia Machines (Holtzman)(CC) Oct 91
 Modem/Fax Protector (Petruzzellis)(C) Dec 43

Monitor
 Technology (Warner) Dec 69
 Tester (Price)(C) Jan 47,(LET)Jun 14
 More
 From the AES Convention:
 Let's Phase the Music (Klein)(AUD) May 73
 from the Mail Bag (Klein)(AUD) Feb 85
 on Automotive Voltage Regulators (Grossblatt)(DB) Jan 75

Motor Speed Controller (ARE) Feb 12,(LET)May 16
 Multidyne TS-8-MTS TV Test-Signal Generator (ER) Jun 16

MULTIMEDIA
 CD-1 (Holtzman)(CC) Dec 97
 CD-ROM Science and Technical Reference Set, McGraw-Hill (ER) Jan 22
 CDTV (Holtzman)(CC) Dec 97
 Cheshire Cat, Multimedia, and Vision (Holtzman)(CC) Sep 97
 Devices (Holtzman)(CC) Dec 97
 Machines, Miniature (Holtzman)(CC) Oct 91
 Mayhem (Holtzman)(CC) Jan 84
 VIS (Holtzman)(CC) Dec 97

N

Navigation and Navicubes (Lancaster)(HH) Dec 77
 Neo-Geo Interface Cables (Lancaster)(HH) Jul 75
 Networking, From Not-Working To (McClellan) Aug 55, Sep 53, Oct 53

NEW LIT (D) Jan 30, Feb 27, Mar 30, Apr 29
 May 28, Jun 28, Jul 30, Aug 30
 Sep 33, Oct 32, Nov 28, Dec 32

NEW PRODUCTS (D) Jan 24, Feb 22, Mar 26, Apr 26
 May 24, Jun 22, Jul 22, Aug 24
 Sep 24, Oct 22, Nov 24, Dec 22

Now's the Time (Steckler)(ED) Sep 4, Oct 4

O

OS/2 2.0
 and Windows 3.1 (Holtzman)(CC) Jun 84
 IBM (Holtzman)(CC) Apr 80
 Ockham's Razor Revisited (Lancaster)(HH) Jun 69
 One-Inch Recorder Heads (ARE) Aug 14
 Optocoupler Devices (Marston) Aug 44

Optoelectronics
 Working With LED Display Drivers (Marston) Mar 65, May 65
 LED's (Marston) Jan 50, Feb 69

Oscillator Circuits, 555-based (Marston) Oct 69

OSCILLOSCOPE
 Back to Automotive Regulators and Forward to our (Grossblatt)(DB) May 82
 CompuScope Lite PC, Gage Applied Science (ER) Aug 22
 is Shaping Up Nicely, Our (Grossblatt)(DB) Mar 82
 Let's Add the Final Touches to Our (Grossblatt)(DB) Jul 88
 Our Long-Lost Discussion on Digital Scopes (Grossblatt)(DB) Feb 88
 Our Oscilloscope is Shaping Up Nicely (Grossblatt)(DB) Mar 82

P

PC Password Protection (Hatten)(C) Jul 51

PC-Based Test Bench (Wolfe)(C) Jun 39, Jul 41, Aug 80, Oct 47
 PageAhead Software, InfoPublisher (Holtzman)(CC) Nov 88
 Paper Software's SideBar (Holtzman)(CC) Jan 84
 Paragon Engineering LA16PC Logic Analyzer (ER) Jul 21
 Patents (Lancaster)(HH) Jul 75
 Pen-Based Computing (Holtzman)(CC) Feb 91
 Perpetual Motion (Lancaster)(HH) Feb 77
 Personal Digital Assistant, The (Holtzman)(CC) May 75
 Phone-Line Monitor, Intelligent (Black)(C) Apr 52, Mar 53

PHOTOGRAPHY
 Build This Super Strobe (Simonton and Simonton)(C) Nov 31
 Photo CD (Holtzman)(CC) Dec 97
 Photolab Release 3.0, Global Specialties (ER) Apr 24
 Photosensitive Devices (Marston) Jul 83
 Piano and Organ Resources (Lancaster)(HH) Mar 73
 Pick Up The Heartbeat (ARE) Jul 10
 Piezo Rate Gyros (Lancaster)(HH) Dec 77
 Pocket-Stereo Amp (ARE) Aug 14, (LET) Nov 16, (LET) Dec 14
 Polapulse Recycler, Build The (Spiwak)(C) May 64
Power
 Controller for Automotive Accessories, Build A (Sweeney)(C) Nov 57
 Inverter, 250-Watt (Melton)(C) Oct 75
 Supply Repair (ARE) Jan 12
 Probe, Differential (Dorfman) Oct 61
 Pseudoscience Research (Lancaster)(HH) Nov 68

Q

Q&A (D) Sep 12, Oct 12, Nov 12, Dec 12
 Qic-40 Tape Backup (QA) Dec 12

R

RF Spectrum Prepped for Next Century: WARC 92 (Leinwoll) Jul 38
 RGB Monitor Fundamentals (Lancaster)(HH) Jul 75
RADIO
 AM Tries for a Comeback (Feldman) Feb 48
 Scanner Converter (Sheets and Graf)(C) Feb 42, Mar 41
 WARC 92: RF Spectrum Prepped For Next Century (Leinwoll) Jul 38
 Reader Questions: Real and Imagined, Serious and Silly (Klein)(AUD) Jan 73
 Reflex Timer, Build This (Kennedy)(C) Oct 43
 Relay, Solid-State (Kreuter)(C) May 47

REMOTE CONTROL

for your Dog (Canino)(C) Apr 47
 Universal (Eady)(C) Nov 47
 Robot Bug, Build This (Sonntag and Chaney)(C) Jun 33
 Russian Dolls and the Virtual PC (Holtzman)(CC) Jul 90

S

SSAVI
 Descrambler, Let's Get Back to Our (Grossblatt)(DB) Dec 88
 Signal, Let's See What's Involved in Descrambling (Grossblatt)(DB) Oct 88
 Santa Claus Machine BBS (Lancaster)(HH) Aug 72
 Scanner Converter (Sheets and Graf)(C) Feb 42, Mar 41
 Schmitt Trigger (Marston) Nov 61
 Scrambler, Telephone (Rosenmayer)(C) Aug 37
 Semiconductor IC Houses (Lancaster)(HH) Oct 79
 Shields and Shielding (Lancaster)(HH) Jan 67
 SlideBar, Paper Software's (Holtzman)(CC) Jan 84
 Simple Charger (ARE) May 12
 Single-Chip Messaging System (Tenney)(C) Mar 59
 Sloping Vee Antenna (Formato)(C) Sep 71
 Snooper Stopper, Build The (Wolf)(C) Apr 37, (LET) Sep 16

SOFTWARE
 Dallas Semiconductor Touch Memory Starter Kit (ER) Mar 24
 Global Specialties Photolab Release 3.0 (ER) Apr 24
 iBM OS/2 (Holtzman)(CC) Aug 80
 iBM OS/2 2.0 (Holtzman)(CC) Apr 80
 Industry Evolution (Holtzman)(CC) Mar 90
 McGraw-Hill CD-ROM Science and Technical Reference Set (ER) Jan 22
 Multimedia Mayhem (Holtzman)(CC) Jan 84
 Lantastic 4.0 (Holtzman)(CC) Mar 90
 Sytron Corp. Sytos Plus (Holtzman)(CC) Sep 97
SOFTWARE (SEE COMPUTER)
 Solid-State Relay (Kreuter)(C) May 47, (LET) Sep 16

Speaker Mate (Plant)(C) Jan 43
 Speeding Cursor (QA) Sep 12
 Strobe, Super (Simonton and Simonton)(C) Nov 31
 Super Nintendo Update (Lancaster)(HH) Jun 69
 Super Strobe (Simonton and Simonton)(C) Nov 31
 Surf Man (Simonton)(C) Aug 33
 Surge Suppressor, Fax/Modem (Petruzzellis)(C) Dec 43
 pg. 0
Surplus Resources (Lancaster)(HH) Jul 75
 Sync-Separator Circuit (Lancaster)(HH) Apr 63
 Sweep/Function Generator (Lashansky)(C) Jan 35, Feb 53
 Synchronous Rectifier Ideas (Lancaster)(HH) Aug 72
 Syndicated Reviewers, AM Stereo, and Consumer Fraud (Klein)(AUD) Oct 78

T

T1000 Universal Interface Card PC-Based Test Bench (Wolfe)(C) Jun 39
 T1003 Interface PC-Based Test Bench (Wolfe)(C) Aug 60
 T1004 Digital Logic IC Tester PC-Based Test Bench (Wolfe)(C) Oct 47

TELEPHONE
 Intelligent Phone-Line Monitor (Black)(C) Mar 53, Apr 52
 Hold Button (Green)(C) Nov 45
 Telephone Scrambler (Rosenmayer)(C) Aug 37
 Speaker Mate (Plant)(C) Jan 43

TELEVISION
 Cable TV's Infamous Bullet (Foley) Jan 33
 TV/FM Booster Circuits (Lancaster)(HH) Nov 68
 TV Test-Signal Generator, Multidyne TS-8-MTS (ER) Jun 16

Temperature
 Alarms, 555-based (Marston) Nov 61
 Measurement, Electronic (Trietley) Mar 46, Apr 40

Test Bench, PC-Based (Wolfe)(C) Jun 39, Jul 41, Aug 60, Oct 47

TEST EQUIPMENT
 Back to Automotive Regulators and Forward to our Oscilloscope (Grossblatt)(DB) May 82
 Beckman Industrial DM10XL Digital Multimeter (ER) Sep 22
 HD160 Digital Multimeter (ER) Dec 16
 Buyer's Guide to DMM's (Prentiss) May 31
 Car Battery Tester (Fox)(C) Jul 57
 Checker Computer-Monitor Tester, The (ER) Oct 16
 Differential Probe (Dorfman) Oct 61
 Gage Applied Science CompuScope Lite PC Oscilloscope (ER) Aug 22
 Kelvin 100K Digital Multimeter (ER) Feb 16
 Let's Add the Final Touches to Our Oscilloscope (Grossblatt)(DB) Jul 88
 Let's Work on the Vertical Section of our Scope (Grossblatt)(DB) Apr 72
 Monitor Tester (Price)(C) Jan 47
 Multidyne TS-8-MTS TV Test-Signal Generator (ER) Jun 16
 Our Long-Lost Discussion on Digital Scopes (Grossblatt)(DB) Feb 88
 Our Oscilloscope is Shaping Up Nicely (Grossblatt)(DB) Mar 82
 PC-Based Test Bench (Wolfe)(C) Jul 41, Aug 60, Oct 47
 Sweep/Function Generator (Lashansky)(C) Jan 35, Feb 53

Tester, Car Battery (Fox)(C) Jul 57
 Testing the Testers (Klein)(AUD) Jun 76
 Thermostat, Electronic (Kreuter)(C) Jun 53
TIMER IC'S
 555: A Versatile Timer (Marston) Sep 58
 Timer, Reflex (Kennedy)(C) Oct 43
 Top-Octave Generators (Lancaster)(HH) Mar 73
 Touch Memory Starter Kit Dallas Semiconductor (ER) Mar 24
 Turn-Signal Amplifier (ARE) Apr 12, (LET) Sep 16, (LET) Dec 14

U

UFO Resources Listing (Lancaster)(HH) Nov 68
 UHF and VHF Amplifiers (Lancaster)(HH) Nov 68
 Universal Remote Control (Eady)(C) Nov 47
 User Manifesto, A (Holtzman)(CC) Aug 80
 Using the IC Master (Lancaster)(HH) Mar 73

V

VFX Digital Signal Processor (Borax and Beck)(C) Sep 37
 VGA Adapter for the Mac LC (Lancaster)(HH) Jan 67
 VIS (Holtzman)(CC) Dec 97
 Versatile 555, The (Marston) Dec 62
VIDEO (SEE ALSO TV, VIDEO NEWS)
 ATV Downconverter (Sheets and Graf)(C) Sep 79
 Linear Amp (Graf and Sheets)(C) Aug 67
 Amps Revisited, Classic (Perez) Jun 57

January 1993, Electronics Now

Cable TV's Infamous Bullet (Folsy)	Jan 33
Let's See What's Involved in Descrambling a SSAVI Signal (Grossblatt)(DB)	Oct 88
Fader (ARE)	Mar 12
IC's (QA)	Sep 12
Interface Module (Lancaster)(HH)	Apr 63
Mixer (ARE)	Jul 10
Scrambler, Let's Build Our Own! (Grossblatt)(DB)	Nov 84
Scrambling (ARE)	Jun 12
Scrambling (Grossblatt)(DB)	Sep 95
Scrambling, Let's Explore the Mysteries of (Grossblatt)(DB)	Aug 27
VIDEO NEWS (D)	Jan 6, Feb 6, Mar 6, Apr 6 May 6, Jun 6, Jul 6, Aug 12

Virtual PC, the and Russian Dolls (Holtzman)(CC)	Sep 8, Oct 8, Nov 6, Dec 8 Jul 90
W	
WARC 92: RF Spectrum Prepped For Next Century (Leinwoil)	Jul 38
Wavelet Shareware (Lancaster)(HH) Update (Lancaster)(HH)	Feb 77 Mar 73
WHAT'S NEWS (D)	Jan 4, Feb 4, Mar 4, Apr 4 May 4, Jun 4, Jul 6, Aug 6

Will You OS/2 It? (Holtzman)(CC)	Sep 6, Oct 5, Nov 5, Dec 6 Apr 80
Windows 3.1, OS/2 2.0 (Holtzman)(CC)	Jun 84
Word for Windows 2.0 (Holtzman)(CC)	Mar 90
Working With	
LED Display Drivers (Marston)	Mar 65, May 65
LED's (Marston)	Jan 50, Feb 69
555, The Versatile (Marston)	Dec 62
World Administrative Radio Conference WARC 92: RF Spectrum Prepped For Next Century (Leinwoil)	Jul 38

WORLD BAND RECEIVER

continued from page 38

in Fig. 8-a) in the center series arm. This is the most important bandpass filter in the receiver and it must be aligned correctly.

Check the filter in the receiver by listening with the headphones for a stable signal within the 16.45 to 17.1 MHz range. The 11th harmonic at 16.5 MHz of the band 5 (refer to Fig. 4-d) oscillator/divider output of 1.5 MHz will be satisfactory.

Tune across the band while monitoring the DC voltage on the detector AGC line. The voltage should rise very rapidly to more than 5 volts, hold steady, and then drop rapidly to zero. With a frequency counter connected to capacitor C48 and a voltmeter calibrated in decibels on the AGC line, verify that your filter output matches the curve in Fig. 9.

Obtain an RF signal generator and an RF voltmeter. Mount the four inductors on the copper-clad side of the 1 x 3-inch board 4. Then connect the end capacitors (fixed and variable) as shown in Fig. 10. To check the LC resonant circuit at each end, set the RF generator to the filter's mid frequency (16.772 MHz) and adjust the 1—16 pF capacitor in parallel with the 110 pF capacitor that forms C1 for a peak reading (parallel resonance) on the RF voltmeter.

Now connect inductor L4 and the two capacitors forming C2 (a 39 pF capacitor in parallel with a 1 to 16 pF capacitor) shown in Fig. 11. Set the RF signal generator for 17.897 MHz, and adjust for a null (series resonance). Repeat this step with L5 and C3 tuning for a null at 15.713 MHz. Then without

changing capacitor settings, connect the filter components in their final positions as shown in Fig. 8-b. Frequencies for the other bands are shown in Table 2.

The first mixer converts each of the popular shortwave bands to the 16.45 to 17.1 MHz range. The mixer in this receiver is a double-balanced mixer.

Filter construction

Build the four crystal-controlled oscillators that tune the six bands of the receiver by referring to the schematics in Fig. 4. Note that 7 MHz-crystals are used in both the band 1 and 2 oscillators (XTAL 7 and XTAL 8), but a 10 MHz crystal (XTAL9) is used in the band 3 oscillator (Fig. 4-c). The oscillator in Fig. 4-d is able to provide three different frequencies because of its output countdown circuitry (IC8, IC9, IC10 and IC11).

Filter details are given in Table 2. Filters are built with fixed-value capacitors and tuning is accomplished by adjusting the position of the wire turns on the toroid cores. Compressing the turns to less than 360 degrees of the toroid's circumference increases their inductance and lowers their resonant frequency.

For example, compressing a coil whose turns are spread out over 360° down to about an angle of coverage of about 120 degrees increases the inductance 75%, shifting the frequency 32% lower. Follow the procedure outlined for the first IF bandpass filter, but use the frequencies listed in Table 2. Filter components are mounted directly on the 6 x 3 1/4-inch circuit board 1. (See Figs. 1 and 2.)

Automatic gain control

Refer to Fig. 3 and build the

automatic gain control (AGC) circuit last. It allows this receiver to cope with a wide range of signal strengths while the listener tunes across the band. The volume control knob can be left in a fixed position and all tuning can be done with the TUNE control.

Set the 10K potentiometer, R68, for 5 volts DC at the cathode of diode D5 with no signal input to the receiver. This level will increase to about 6 volts in the presence of strong signals, causing a reduction in the gain of the IF amplifiers. Refer to Fig. 12 and build the 9.83 MHz crystal filter on board 5 whose dimensions are given in Table 1.

Precision tuning dial

Cut and bend a mounting bracket for the air-dielectric tuning capacitor C49 from aluminum stock and drill a hole in it to accept the capacitor shaft and two holes at its base flange 1/4 inch back from the front edge so it can be mounted to the baseplate as shown in Fig. 13. (Capacitor C49 is part of the variable-frequency oscillator circuit.)

Mount tuning capacitor C49 on the bracket positioned about 1 1/4 inches behind the front panel as shown in Fig. 13. The tuning capacitor is rotated by an assembly shown in Fig. 13 consisting of a 3-inch diameter pulley turned by a nylon cord wound over the tuning knob spindle and located in the vee groove of the pulley.

The pulley can be turned from sheet plastic in a lathe or a suitable one might be obtained from electronic salvage. Two slots cut in the edge of the pulley allow the cord ends to pass through the wall of the vee-groove for fastening. A small

continued on page 86

HARDWARE HACKER

High-side FET drivers, drawing semilog plots, resonance fundamentals, laser-printing repair kits, and Asian electronic sources.

DON LANCASTER

A few additional comments on the correlation from back in our August 1992 column. Our third autocorrelation mask example obviously should have been 0010 rather than the typo shown.

I should have stated "Radar range depends upon transmitted pulse energy," rather than "is proportional to." Doubling the transmitted radar pulse energy typically can extend effective range by only nineteen percent.

Good classic texts on radar include Merrill Skolnick's *Radar Handbook*, and the hoary "Rad Lab One" which refuses to die—otherwise known as *Radar Systems Engineering* by Louis Ridenour. Another very outdated but popular introduction is Robert Page's *Origin of Radar* from Doubleday.

While much of the information on chirp-radar techniques is classified or otherwise hard to locate, the *Theory and Design of Chirp Radars* in the *Bell System Technical Journal* of July 1960 is a good introduction. I've also got a summary in my January 1965 *Electronics World* chirp story. More current information can be found through the *Dialog Information Service*.

Several readers questioned the synchronous rectification example circuit. Yes, this is correct as shown. And, yes, there is one hidden "gotcha." When a MOS power transistor is used as a synchronous rectifier, it is run in its *third* quadrant. Not the first quadrant as you might initially expect. That's done to keep the substrate diode from shorting out the works. More on this subject below.

Additional details on synchronous rectifiers appear in that *MosPower Applications Handbook* by Siliconix and in those *Motion, Motion Control, PCIM*, or *PowerTechniques* magazines.

Fundamentals of resonance

Resonance is certainly one of the most interesting and important electronic concepts. But there sure seems to be lots of helpline confusion over what resonance can and cannot do. Yes, you can produce incredible energy buildups in certain resonant circuits—destructive and even lethal ones. Yes, you can extract this energy if you want. No, none of the stored resonant energy is "free." Just as in a piggy bank, you cannot take more quarters out than were put in. One hundred percent of all earlier attempts at "free" resonant energy have failed miserably. Let's take a fresh look at resonance fundamentals...

Figure 1 shows the simple series combination of a resistor, an inductor, and a capacitor. This is a *series resonant circuit*. Assume for now that the resistance is your load, the inductor and capacitor are very high quality, and the signal source is a very low impedance.

At extremely low frequencies, the inductor will look like a short circuit and the capacitor will appear as a very high capacitive reactance. Very little signal will reach the load.

Similarly, at very high frequencies, the capacitor will look like a short circuit, and the inductor will appear as a rather high inductive reactance. And once again, very little signal will reach the output load resistor.

At one specific frequency, though, both of the inductive and

capacitive reactances will be equal in magnitude and opposite in sign, *and will cancel out to zero*, transferring *all* of the input signal to the output load. This "magic" frequency is defined as the *resonance frequency*.

As Fig. 1 shows us, the resonance frequency is determined by the *product* of its L and C values. Resonant circuits are often *frequency selective*. They allow you to *tune* to a chosen frequency. This is how you select any particular AM or FM radio station while you tune out all of the others. Resonant circuits can also store surprisingly large quantities of energy. One very important energy storage use for resonant circuits is in the deflection circuitry of television sets and computer monitors. Sneaky resonant switching tricks are used to sweep the beam back and forth while recycling the available energy.

The "Q" of a series resonant circuit can be defined in several unique ways. Q (standing for *quality*) could be defined as the ratio of the resonant inductive reactance to the load resistance. Or as the *bandwidth* between the -3-decibel *half power points*. Or as a function of the *ringing decay time*. Or as the amount of the resonant voltage *increase* obtained across the inductor or capacitor. Or as the ratio of the stored to the dissipated energy per cycle.

All of the Fig. 1 definitions of Q are identical, but they will lead you to profoundly different redundant applications for resonant circuits.

You can change the resonant frequency by shifting the LC *product*. You can also change the Q by shifting the LC *ratio*.

Figure 2 shows exactly how the response of series resonant circuits will change with frequency and Q. The higher the Q, the *narrower* the final bandwidth between the half

NEED HELP?

Phone or write your **Hardware Hacker** questions directly to:
Don Lancaster
Synergetics
Box 809
Thatcher, AZ 85552
(602) 428-4073

power (or 0.707 voltage amplitude) points. Note that each of these curves starts out by rising at +6 decibels per octave, swings up through a sharp resonance peak, and then eventually ends up falling at a -6-decibels-per-octave rate. No matter how steep the near-resonance dropoff, it reaches a point where either the inductor or the capacitor reactance is too small to make much difference.

If you need more attenuation well away from the resonance frequency, you usually are better off adding extra series-resonant poles, or otherwise cascading poles.

You can quickly sketch most resonant curves. You should get zero attenuation at the center frequency, and 3 decibels of attenuation at the half-power bandwidth points set by $1/Q$. You can then locate the resonant frequency point Q (converted to decibels down) and sketch a pair of 6-decibel-per-octave lines on down from there. Then smoothly connect all of the dots and the lines.

In high- Q series-resonant circuits, the usual reactive voltage

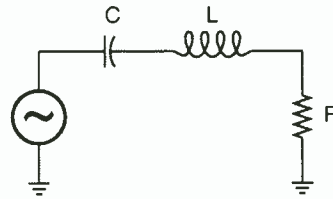

The **RESONANCE FREQUENCY** occurs whenever both the inductive and capacitive reactances are equal...

$$f_o = \frac{1}{2\pi\sqrt{LC}}$$

The **AMPLITUDE RESPONSE** defines the ratio of the input to the output voltage, expressed in decibels...

$$\frac{e_{out}}{e_{in}} = -20 \text{ Log}_{10} \sqrt{1 + Q^2 \left[\frac{f^2 - f_o^2}{f} \right]^2}$$

The **Q** or **QUALITY FACTOR** is defined in several different ways, each of which leads to a different application...

(A) As the reactance to resistance ratio...

$$Q = \frac{2\pi f_o L}{R}$$

(B) As the half power bandwidth...

$$Q = \frac{f_o}{f_h - f_l}$$

(C) As the inverse of the damping...

$$Q = \frac{1}{d}$$

(D) As the resonant voltage rise...

$$Q = \frac{(\text{resonant voltage across L or C})}{(\text{resonant voltage across R})}$$

(E) As the ringing rundown time...

A resonant circuit decays to $1/\epsilon$ amplitude (or 37% = -8.7 decibels) in Q/π cycles.

(F) As the stored energy ratio...

$$Q = \frac{2\pi(\text{energy stored per cycle})}{(\text{energy dissipated per cycle})}$$

FIG. 1—AN RLC SERIES RESONANT CIRCUIT forms the basis for many electronic tuning, filtering, voltage step up, and energy storage circuits. But there is no way I know that it can produce "free" energy. Let me know if you find one.

across the inductor or capacitor will be many times that of the input. For instance, a 1-volt input at resonance and a Q of 100 will produce a nasty 100 volts across the capacitor or the inductor. Some switching-mode power supplies make use of this resonant rise for a transformer-free voltage increase.

The resonant voltage step up can easily become destructive if the input signal becomes too big.

Just as a pendulum swaps kinetic

for potential energy as it oscillates, the inductor stored $L^2/2$ energy is at a maximum on current peaks, and the capacitor stored $CV^2/2$ energy is at a maximum on voltage peaks. While the energy appears to swap back and forth between inductor and capacitor, *the total stored energy over any one cycle remains constant.*

One definition of Q is 2π times the energy stored per cycle divided by the energy dissipated per cycle.

**NEW FROM
DON LANCASTER**

HARDWARE HACKER STUFF

Hardware Hacker Reprints II or III	24.50
Midnight Engineering Reprints	18.50
Resource Bin Reprints	12.50
Incredible Secret Money Machine	18.50
CMOS Cookbook	24.50
TTL Cookbook	24.50
Active Filter Cookbook	24.50
Micro Cookbook vol I or II	19.50
Lancaster Classics Library	219.50

POSTSCRIPT STUFF

Ask The Guru Reprints I, II or III	24.50
PostScript Secrets (Ile/Mac/PC)	39.50
PostScript Show & Tell	39.50
Intro to PostScript VHS Video	39.50
PostScript Beginner Stuff	39.50
PostScript Cookbook (Adobe)	16.50
PostScript Ref. Manual II (Adobe)	28.50
PostScript Program Design (Adobe)	22.50
Type I Font Format (Adobe)	15.50
LaserWriter Reference (Apple)	19.50
Real World Postscript (Roth)	22.50
PostScript Visual Approach (Smith)	22.50
Thinking In PostScript (Reid)	22.50
Undst PS Pgrmmg (Holtzgang)	29.50
The Whole Works (all PostScript)	349.50

BOOK-ON-DEMAND STUFF

Book-on-demand resource kit	39.50
GEnie PSRT sampler (Ile/Mac/PC)	39.50

FREE VOICE HELPLINE VISA/MC

SYNERGETICS
Box 809-RE
Thatcher, AZ 85552
(602) 428-4073

CIRCLE 210 ON FREE INFORMATION CARD

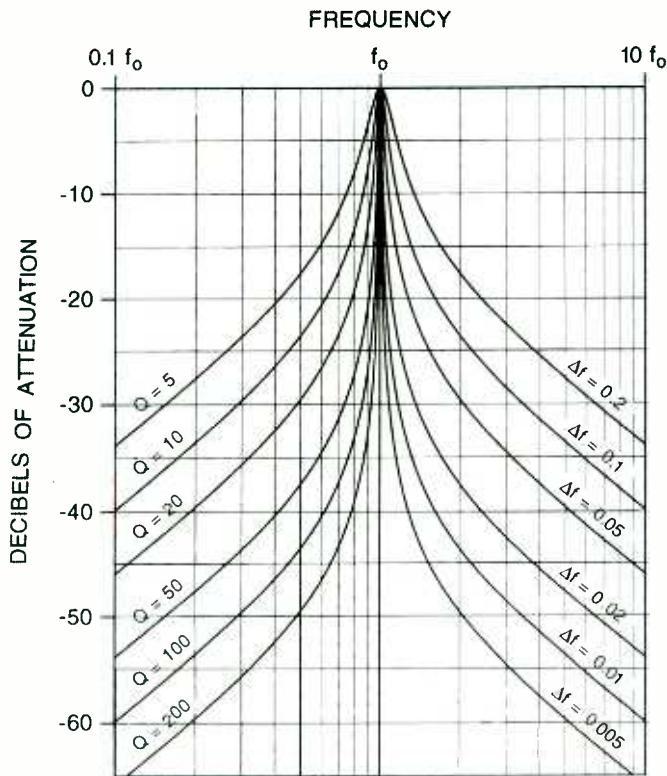

FIG. 2—EXTENDED RESONANCE RESPONSE CURVES for a series RLC circuit. Note the “flattening out” for frequencies well away from resonance.

Thus, if you have a Q of 100, a 1-amp input, and a 1-ohm load, at series resonance it will dissipate 1 watt per cycle while it stores around 15.9 watts per cycle.

Just where did the 15.9 watts come from? The same place the stash in the piggy bank came from. It was built up earlier, a quarter at a time. During the *transient* intervals when you first apply a signal, input energy will slowly be saved, building up the inductor and capacitor energy storage.

Very large amounts of energy can be stored in resonant circuits. In the case of a large color TV or computer monitor, as much as 5 kilowatts of resonant power is involved in the horizontal sweep circuitry—in a very efficient circuit that continuously recycles resonant deflection currents. More on this in the *Hardware Hacker III* reprints.

If you deliver an impulse to a high- Q resonant circuit, it will ring for a *rundown* time as shown in Fig. 1. The higher the Q , the longer the ringing time. One obvious use is in electronic chimes and gongs.

Although I have shown a single resistor in our resonant circuit, it

really has a load resistor, a source-impedance resistor, and the resistive losses in the inductor. All of these have to be accounted for in the real world. For a series resonant circuit to operate, it must be driven from a very low-impedance source.

You can also create the *dual* of this RLC circuit by placing everything in parallel, creating a *parallel resonant circuit*. Any parallel resonant circuit reaches a very *high* impedance at its resonance and operates only when it is driven from a very *high*-impedance current source. Instead of voltages multiplying by Q , the reactive current multiplies by Q instead.

More on resonance fundamentals appears in most electrical engineering texts such as Skilling's *Electrical Engineering Circuits*. And lots more on working with and using resonant circuits appears in my *Active Filter Cookbook*.

PostScript to the rescue

At one time, drawing camera-ready charts and graphs like Fig. 2 was a real hassle. First you had to find some semi-log paper, and then trace it to the correct resolution.

DIGITAL VIDEO STABILIZER ELIMINATES ALL VIDEO COPYGUARDS



While watching rental movies, you will notice annoying periodic color darkening, color shift, unwanted lines, flashing or jagged edges. This is caused by the copy protection jamming signals embedded in the video tape, such as Macrovision copy protection. THE DIGITAL VIDEO STABILIZER: RXII COMPLETELY ELIMINATES ALL COPY PROTECTIONS AND JAMMING SIGNALS AND BRINGS YOU CRYSTAL CLEAR PICTURES.

WARNING

THE DIGITAL VIDEO STABILIZER IS INTENDED FOR PRIVATE HOME USE ONLY. IT IS NOT INTENDED TO COPY RENTAL MOVIES OR COPYRIGHTED VIDEO TAPES THAT MAY CONSTITUTE COPYRIGHT INFRINGEMENT.

FEATURES

- Easy to use and a snap to install
- State-of-the-art Microchip technology
- 100% automatic
- Compatible to all types of VCRs and TVs
- The best and most exciting Video Stabilizer in the market
- Light weight (8 ounces) and compact (1x3.5x5")
- Uses a standard 9 Volt battery (last 1-2 years)
- Fast UPS delivery
- Air shipping available
- UNCONDITIONAL 30 day money back guarantee
- 1 year warranty

(Dealers Welcome)

FREE 20P Catalog

To Order: \$39.95 ea +\$4 for p & h
Visa, M/C, COD Mon-Fri: 9-6 EST

1-800-445-9285

ZENTEK CORP. DEPT. CRE0193

3670-12 WEST OCEANSIDE RD. OCEANSIDE, NY 11572

CIRCLE 180 ON FREE INFORMATION CARD

CABLE TV DESCRAMBLERS How You Can Save Money on Cable Rental Fees

Bullet Proof



1 Unit 5+

BEST Super Tri-Bi Auto/
Var. Gain Adjustment \$119.95...\$85
Jerrod Super Tri-Bi... \$109.95...\$79
Scientific Atlanta..... \$109.....\$79
Pioneer..... \$109.....\$79
Panasonic TZPC145..... \$99.95...\$79
Stargate Converter..... \$95.....\$69
Digital Video Stabilizer. \$59.95...\$29
Wireless Video Sender. \$59.95...\$49.95

US Cable'll Beat
Anyone's Price
Advertised in
this Magazine!

30 Day Money Back Guarantee
FREE 20 page Catalog

Visa, M/C, COD or send money order to:
U.S. Cable TV Inc. Dept. KRE0193
4100 N. Powerline Rd., Bldg. F-4
Pompano Beach, FL 33073

1-800-772-6244

For Our Record

I, the undersigned, do hereby declare under penalty of perjury that all products purchased, now and in the future, will only be used on Cable TV systems with proper authorization from local officials or cable company officials in accordance with all applicable federal and state laws. FEDERAL AND VARIOUS STATE LAWS PROVIDE FOR SUBSTANTIAL CRIMINAL AND CIVIL PENALTIES FOR UNAUTHORIZED USE.

Date: _____

Signed: _____

No Florida Sales!

CIRCLE 181 ON FREE INFORMATION CARD

SEMICONDUCTOR RESOURCES, PART II

Gould AMI

2300 Buckskin Road
Pocatello, ID 83201
(800) 538-7736
CIRCLE 316 ON FREE INFORMATION CARD

Harris Semiconductor

2401 Palm Bay Road
Palm Bay, FL 32905
(305) 724-3739
CIRCLE 317 ON FREE INFORMATION CARD

Hewlett-Packard

PO Box 10301
Palo Alto, CA 94303
(415) 857-1501
CIRCLE 318 ON FREE INFORMATION CARD

Hitachi

2000 Sierra Point Pkwy
Brisbane, CA 94005
(415) 589-8300
CIRCLE 319 ON FREE INFORMATION CARD

Hughes Aircraft

500 Superior Ave M/S B1250
Newport Beach, CA 92658
(714) 759-2727
CIRCLE 320 ON FREE INFORMATION CARD

Hyundai

166 Baypointe Parkway
San Jose, CA 95134
(408) 473-9200
CIRCLE 321 ON FREE INFORMATION CARD

Intech

67 Alexander Drive
Research Triangle, NC 27709
(919) 549-8411
CIRCLE 322 ON FREE INFORMATION CARD

Integrated Circuit Systems

PO Box 968
Valley Forge, PA 19482
(215) 666-1900
CIRCLE 323 ON FREE INFORMATION CARD

Intel

1000 Business Center Dr
Mt. Prospect, IL 60056
(800) 548-4725
CIRCLE 324 ON FREE INFORMATION CARD

Internat'l Microcircuits

525 Los Coches Street
Milpitas, CA 95035
(408) 263-6300
CIRCLE 325 ON FREE INFORMATION CARD

Internat'l Micro Electronics

PO Box 170415
Arlington, TX 76003
(817) 561-2244
CIRCLE 326 ON FREE INFORMATION CARD

Lambda

121 International Blvd.
Corpus Christi, TX 78406
(512) 289-0403
CIRCLE 327 ON FREE INFORMATION CARD

Lattice Semiconductor

5555 NE Moore Court
Mt. Prospect, IL 60056
(800) FAST-GAL
CIRCLE 328 ON FREE INFORMATION CARD

Linear Technology

1630 McCarthy Blvd.
Milpitas, CA 95035
(408) 432-1900
CIRCLE 329 ON FREE INFORMATION CARD

LSI/CSI

1235 Walt Whitman Road
Melville, NY 11747
(516) 271-0400
CIRCLE 330 ON FREE INFORMATION CARD

LSI Logic

1551 McCarthy Blvd.
Milpitas, CA 95035
(408) 433-8000
CIRCLE 331 ON FREE INFORMATION CARD

Maxim Integrated Products

120 San Gabriel Drive
Sunnyvale, CA 94086
(408) 737-7600
CIRCLE 332 ON FREE INFORMATION CARD

Micrel Semiconductor

560 Oakmead Parkway
Sunnyvale, CA 94086
(408) 245-2500
CIRCLE 333 ON FREE INFORMATION CARD

Microchip Technology

2355 W. Chandler Blvd.
Chandler, AZ 85224
(602) 963-7373
CIRCLE 334 ON FREE INFORMATION CARD

Micro Linear

2092 Concourse Drive
San Jose, CA 95131
(408) 433-5200
CIRCLE 335 ON FREE INFORMATION CARD

Micron Technology

2805 East Columbia Road
Boise, ID 83706
(208) 386-3900
CIRCLE 336 ON FREE INFORMATION CARD

Micro Power Systems

3100 Alfred Street
Santa Clara, CA 95054
(408) 727-5350
CIRCLE 337 ON FREE INFORMATION CARD

Micro Switch

11 West Spring Street
Freeport, IL 61032
(815) 235-6600
CIRCLE 338 ON FREE INFORMATION CARD

Mitel

2321 Morena Blvd Ste M
San Diego, CA 92110
(619) 276-3421
CIRCLE 339 ON FREE INFORMATION CARD

Mitsubishi

1050 East Arques Avenue
Sunnyvale, CA 94086
(408) 730-5900
CIRCLE 340 ON FREE INFORMATION CARD

Motorola

PO Box 1466
Austin, TX 78767
(800) 521-6274
CIRCLE 341 ON FREE INFORMATION CARD

MX-Com

4800 Bethania Station Rd
Winston-Salem, NC 27105
(800) 638-5577
CIRCLE 342 ON FREE INFORMATION CARD

National Semiconductor

47 Ellis Street
Mountain View, CA 94043
(800) 632-3531
CIRCLE 343 ON FREE INFORMATION CARD

NCR Microelectronic

3718 North Rock Road
Wichita, KS 67226
(800) 325-SCSI
CIRCLE 344 ON FREE INFORMATION CARD

NEC Electronics

PO Box 7241
Mountain View, CA 94039
(800) 632-3531
CIRCLE 345 ON FREE INFORMATION CARD

Then you had to calculate all of the needed points. Finally, you had to ink them with splines or French curves, messy pens, and similar drafting tools. Final size and detail changes were a real bear. Especially if you had to stretch or shrink it in

one direction only.

Even then, the editor might decide it's not good enough and redo the entire figure from scratch.

These days, instead, you simply use that superb PostScript language to draw the whole job for

you—instantly and hassle-free.

PostScript is one totally *general purpose* and super friendly computer language that is absolutely ideal for many hardware hacking tasks. One of PostScript's utterly minor and almost insignificant capabilities

```
% Requires persistent download of GONZO15.PTL utility from GENie PSRT.
guru save /snap1 exch def 200 300 10 setgrid % 30 30 showgrid
line1 1 setlinecap 10 0 mt 26 u 0 0 mt 26 pu 20 pr 26 pd 20 pl gsave line1 stroke grestore
gsave clip newpath 0 setlinewidth 0 setgray
1 1 10 (log 10 mul 0 moveto 0 28 rlineto stroke) for 10 10 100 (log 10 mul 0 moveto 0 28 rlineto
stroke) for 0 2 28 (0 exch moveto 20 0 rlineto stroke) for
/fnc (dup dup mul 1 sub exch div dup mul Q dup mul mul 1 add sqrt log 20 mul neg) def
/vsf {2 5 div 26 add} def /hsf {log 10 mul 10 add} def /inperdec 200 def /startat 0.1 def
/wholecurve{/Q exch def newpath /val startat def val dup fnc mt inperdec 2 mul 1 add (val fnc
val hsf exch vsf lino to /val val 10 1 inperdec div exp mul def) repeat 0.06 setlinewidth stroke}
def
[5 10 20 50 100 200] {wholecurve} forall grestore
/cstretch 0.01 def /sstretch 0.03 def /yinc 1 def
/font1 /Helvetica 0.85 gonzofont
/font2 /Helvetica-Bold 0.85 gonzofont
/font3 /Helvetica 0.7 gonzofont
/font4 /Symbol 0.75 gonzofont
/font5 /Helvetica [0.7 0 0 0.7 0 -.2] gonzofont
/font6 /Helvetica [0 0.85 -0.85 0 0 0] gonzofont
/b+ (gsave newpath /msg exch def translate 40 rotate 1 setlinecap white 0.8 setlinewidth font3
0.3 mt msg stringwidth pop 0 add r black 0 0.1 msg cl grestore) def
/b- (gsave newpath /msg exch def translate -40 rotate 1 setlinecap white 0.8 setlinewidth font3
0.3 mt msg stringwidth pop -1 add l black 0 0.1 msg cr grestore) def /kern 0.1 def
font1 10 28.3 (FREQUENCY) cc -3.3 8 (16DECIBELS OF ATTENUATION) cl
{[(line1 0 26 mt 0.5 u) 10 3] xprt [(line1 0 2 mt 0.5 l) 4 7] yprt
0 26.9 (0.1k1 f15o) cc 10 26.9 (f15o) cc 20 26.9 (11k0 f15o) cc 1 13.6 (Q = 5) b+ 1 11.2 (Q = 10)
b+ 1 8.8 (Q = 20) b+ 19 13.6 (I4DI3f = 0.2) b- 19 11.2 (I4DI3f = 0.1) b- 19 8.8 (I4DI3f = 0.05) b-
19 5.6 (I4DI3f = 0.02) b- 19 3.2 (I4DI3f = 0.01) b- 19 0.8 (I4DI3f = 0.005) b- 1 5.6 (Q = 50) b+ 1
3.2 (Q = 100) b+ 1 0.8 (Q = 200) b+
font1 -8 25.7 (0) cr -.8 21.7 (-10) cr -.8 17.7 (-20) cr -.8 13.7 (-30) cr -.8 9.7 (-40) cr -.8 5.7
(-50) cr -.8 1.7 (-60) cr
snap1 restore showpage quit
```

FIG. 3—GURU GONZO POSTSCRIPT CODE used to create camera-ready semilog artwork for Fig. 2. Only your favorite word processor is needed!

is to dirty up clean sheets of paper.

In any way you like. Totally device independently. So the same old word processor text file you use for your rough proof copy can also be phototypeset—interchangeably, on any brand of personal computer that you might want to use.

Figure 3 shows the ultra simple PostScript code required to create all the fancy semi-log decibel resonance plots that you see in Fig. 2. You just shove this through your favorite word processor and then send it to a PostScript printer with a two-way communication setup. Ethernet, AppleTalk, Serial, or Shared SCSI communication all seem to work just fine.

I have just posted a PostScript for Hardware Hackers tutorial as #511 NUTS9.PS to my GENie PSRT.

Among the many hundreds of other PostScript-as-language files, the full Smith Chart drawing routines as file #367 SMITHCHT.PS and my printed circuits as #401 PRINCRCT.GPS. The PostScript startup secrets tutorial now ap-

pears as #335 SECRTEMP.GPS and PostScript speedup secrets tutorial as #460 SPEEDUP.PS. Unique PostScript code to let you instantly draw all the camera-ready figures in this column appears as HACKFG59.PS.

Finally, if you do not now have a PostScript printer, I've posted the GHOSTSCRIPT files to PSRT. These let you run PostScript with just about any printer. They also give you full viewable display PostScript on any monitor. The current PSRT banner shows you the latest GhostScript version numbers to use.

While Fig. 2 can easily be done in "raw" PostScript, I've made things even faster and simpler by opening the convenient and powerful layout/illustration dictionary that I use. This file is #517 GONZO15.PTL and is persistently downloaded at the start of your work session. One single "guru" command opens up this set of power tools for you.

You can also write or call me for a free new PostScript secret resources mailer.

Be an FCC LICENSED ELECTRONIC TECHNICIAN!



No costly school. No commuting to class. The Original Home-Study course prepares you for the "FCC Commercial Radiotelephone License." This valuable license is your professional "ticket" to thousands of exciting jobs in Communications, Radio-TV, Microwave, Maritime, Radar, Avionics and more... even start your own business! You don't need a college degree to qualify, but you do need an FCC License.

No Need to Quit Your Job or Go To School
This proven course is easy, fast and low cost! **GUARANTEED PASS**—You get your FCC License or money refunded. **Send for FREE facts now. MAIL COUPON TODAY!**

COMMAND PRODUCTIONS

FCC LICENSE TRAINING, Dept. 90
P.O. Box 2824, San Francisco, CA 94126
Please rush FREE details immediately!

NAME _____
ADDRESS _____
CITY _____ STATE _____ ZIP _____

SUPER 12 HOUR RECORDER

CALL TOLL FREE

Modified Panasonic Slimline,
6 hrs per side
120 TDK tape furnished.
AC/DC Operation.
Quality Playback.
Digital Counter.
Durable Lightweight Plastic.



\$119.00*

PHONE RECORDING ADAPTER

Starts & Stops Recorder
Automatically When
Hand Set is Used.
Solid State!



FCC Approved

\$28.50*

VOX VOICE ACTIVATED CONTROL

Solidstate Adjustable
Sensitivity. Voices &
Sounds Activate Recorder
Adjustable Sensitivity
Provisions for Remote
Mike



\$28.50*

* Add for ship. & handling. Phone Adapter & Vox \$2.00 each, Recorders \$5.00 each. Colo. Res add tax. Mail Order, VISA, M/C, COD's OK. Money Back Guar. Qty Disc. available. Dealer inquiries invited. Free data on other products.

AMC SALES INC. 193 Vaquero Dr.
Boulder, CO. 80303
Phones (303) 499-5405 1-800-926-2488
FAX (303) 494-4924
Mon-Fri 8-5 MTN. TIME

CIRCLE 108 ON FREE INFORMATION CARD

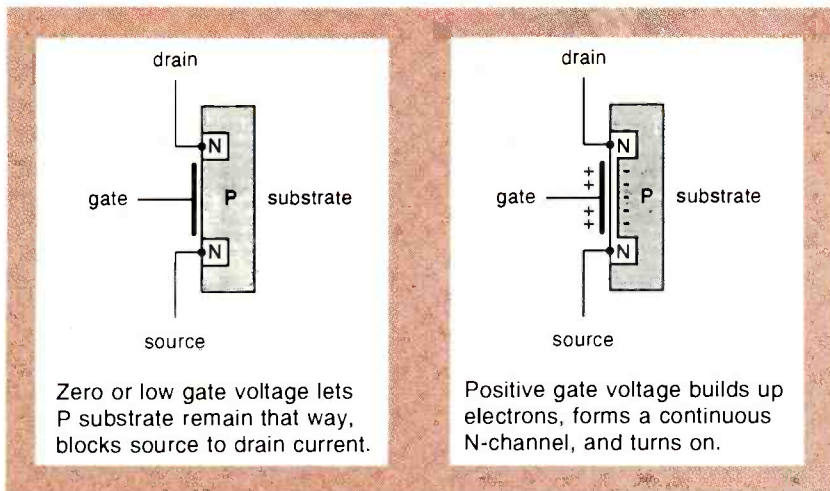

FIG. 4—THE N-CHANNEL POWER MOSFET is now the most popular and most economical power switch in use today. Increasing the gate voltage above its threshold value turns the device on.

High-side drivers

There's a new game in town called *high-side drivers* that are becoming super important. A high-

side driver is a solid-state relay placed between the positive DC supply line and any circuit loads that you wish to control.

Automotive people like high-side drivers because only a single wire is needed for each load; the chassis forms the ground return. Laptop and palmtop computer folks like high-side drivers because the inputs and outputs of the controlling circuits are not hurt by any floating grounds.

Many high-side drivers are smart enough to protect themselves against shorts, overloads, and other faults. What gets tricky fast about high-side drivers is that the preferred choice in any electronic switch today is the N-channel power MOSFET. To turn on an N-channel MOSFET that's connected to a positive supply voltage, you need a gate control signal well *above* that of the positive supply.

Before we see just how we can get a control signal that is well above that of the most positive supply line, let's briefly review just what

NAMES AND NUMBERS

EG&G Reticon

345 Potrero Avenue
Sunnyvale, CA 94086
(408) 245-2060
CIRCLE 352 ON FREE INFORMATION CARD

Maxim

120 San Gabriel Drive
Sunnyvale, CA 94086
(408) 737-7600
CIRCLE 359 ON FREE INFORMATION CARD

ASD/AMD Trade News

2525 Ocean Park Blvd
Santa Monica, CA 90405
(800) 421-4511
CIRCLE 346 ON FREE INFORMATION CARD

Garden Way Products

102nd Street & 9th Avenue
Troy, NY 12180
(800) 732-6354
CIRCLE 353 ON FREE INFORMATION CARD

Motorola

5005 E McDowell Road
Phoenix, AZ 85008
(800) 521-6274
CIRCLE 360 ON FREE INFORMATION CARD

Asian Sources/Wordright

1020 Church Street
Evanston, IL 60201
(708) 475-1900
CIRCLE 347 ON FREE INFORMATION CARD

GEne

401 N Washington Street
Rockville, MD 20850
(800) 638-9636
CIRCLE 354 ON FREE INFORMATION CARD

Siliconix

PO Box 54951
Santa Clara, CA 95056
(408) 988-8000
CIRCLE 361 ON FREE INFORMATION CARD

Bell System Tech Journal

101 John F. Kennedy Parkway
Short Hills, NJ 07078
(201) 564-4454
CIRCLE 348 ON FREE INFORMATION CARD

Hewlett-Packard

PO Box 10301
Palo Alto, CA 94303
(800) 752-0900
CIRCLE 355 ON FREE INFORMATION CARD

Speleonics

Box 5283
Bloomington, IN 47407
(812) 339-7305
CIRCLE 362 ON FREE INFORMATION CARD

Cherry Semiconductor

2000 S County Trail
East Greenwich, RI 02818
(401) 885-3600
CIRCLE 349 ON FREE INFORMATION CARD

Industrial Market Place

7842 N Lincoln Avenue
Skokie, IL 60077
(800) 323-1818
CIRCLE 356 ON FREE INFORMATION CARD

Texas Instruments

PO Box 809066
Dallas, TX 75380
(800) 336-5236
CIRCLE 363 ON FREE INFORMATION CARD

Dallas Semiconductor

4401 S Beltwood Pkwy
Dallas, TX 75244
(214) 450-0448
CIRCLE 350 ON FREE INFORMATION CARD

International Rectifier

233 Kansas Street
El Segundo, CA 90245
(310) 322-3331
CIRCLE 357 ON FREE INFORMATION CARD

Don Thompson

23072 Lake Center Dr #100
El Toro, CA 92630
(714) 855-3838
CIRCLE 364 ON FREE INFORMATION CARD

Dialog

3460 Hillview Avenue
Palo Alto, CA 94304
(415) 858-2700
CIRCLE 351 ON FREE INFORMATION CARD

Linear Technology

1630 McCarthy Blvd
Milpitas, CA 95035
(408) 432-1900
CIRCLE 358 ON FREE INFORMATION CARD

Trade Winners

PO Box 2868
Vancouver, WA 98668
(206) 694-1765
CIRCLE 365 ON FREE INFORMATION CARD

an N-channel MOSFET is and how it works. Fig. 4 shows details.

You start with a block of P-doped silicon known as the *substrate*. Add a non-rectifying or an *ohmic* terminal to it. Now you implant two N-channel wells in the substrate. Add ohmic contacts to these and call them the *source* (on the bottom) and the *drain* (on top). Now, build a capacitor by adding a superthin dielectric layer and a conductor between the source and drain. Call this lead the *gate*.

If the gate is at a zero or negative potential with respect to the source, there will be a zero drain-to-source current, (the MOSFET looks like a pair of back-to-back diodes). There will also *never* be any steady-state gate current, because all the gate does is charge or discharge a small capacitor.

Let the gate become somewhat positive with respect to the drain. Electrons have to pile up on the substrate side of the gate capacitor, so that area will become *less* of a P-type material. Let the gate voltage exceed a *threshold* value, and the extra electrons on the substrate side will actually change the substrate into a continuous N *channel* between source and drain. We now have three N regions tied together into a solid block. These look like a plain old resistor and allow current to pass between source and drain.

Below the threshold voltage, there will be an open circuit between source and drain. Above threshold, there will be a small resistor between source and drain. A grounded gate turns it *off*. A gate above the threshold voltage turns it *on*. The typical threshold is around +4 volts or so, but to turn the device solidly on, a gate-to-source voltage of +10 volts is preferred.

Unlike the NPN power transistors, there are no saturation effects or PN junctions in the main current path. There is also zero steady-state gate current needed. A MOSFET that is turned on acts as a plain old low-value resistor.

The "on" resistance of a single N-channel MOSFET isn't really that great. For instance, in the CMOS 4066 quad analog switch, the on resistance is a high 16 ohms or so. To beat that, power MOSFETS are

made up of hundreds, or even thousands of tiny MOSFET transistors all internally connected in parallel.

There are lots of sources for power MOSFET chips. *Motorola*, *Siliconix*, *Texas Instruments*, and *International Rectifier* are some. Because of their quite low cost and high gain, MOSFET's have become the main power switch of choice for many electronic uses. Although there are also P-channel MOSFET's, they cost more and are less efficient. And because of certain fundamental device physics, they are likely to remain so.

Since a power MOSFET turned on is really nothing but a resistor, *it does not matter which direction the main current goes*. If you do the obvious and make the drain go positive with respect to the source, it is said to be in *quadrant I*. If you make the drain negative with respect to the source, you end up in *quadrant III*. High-side drivers work in quadrant I. But most synchronous rectifiers that use MOSFETS normally run in quadrant III to avoid sub-

strate diode conduction.

To use an N-channel MOSFET as a high-side driver, just connect the drain to the positive supply, and the source to the load being controlled. To turn the switch off, leave the gate at or below the positive supply voltage. To turn the switch on, connect the gate to a value well *above* that of your positive supply, typically by +10 volts or so.

A number of new low-cost integrated circuits are now available that use *charge pumps* and similar circuit tricks to let you reliably apply N-channel MOSFETS as high-side power switches. Typical examples include the *International Rectifier* IR2125, the *Maxim* MAX620, and the *Linear Technology* LTC1155.

The LTC1155 is a very interesting device. It has a self-protecting pair of micropower dual high-side drivers in a single eight-pin mini-DIP. A dual high-side circuit breaker is shown in Fig. 5.

Here is how either half of this circuit works: A built-in charge pump
continued on page 81

Cable TV Article Parts

We stock the exact Parts & PC Board for an article published in Radio Electronics Magazine on building a Snooper Stopper.

Snooper Stopper Kit.....\$19.95
Includes all the original Parts & Etched, Drilled Silk-Screened PC Board.

Snooper Stopper.....\$39.00
This is an assembled and tested fixed frequency 106.5Mhz. Snooper Stopper for most Jerrold systems.

Protect yourself from descrambler detection and stop the Bullet with one of our Snooper Stoppers.

Macrovision..now you see it, now you don't.

Macrovision Kit.....\$29.00
Includes all the original Parts & Etched, Drill Silk-Screened PC Board. Originally Published in Radio Electronics Magazine.

Call Toll Free 1-800-886-8699

Visa, MasterCard or COD

**Northeast Electronics, Inc.
PO Box 3310
N. Attleboro, Ma. 02761**

CIRCLE 182 ON FREE INFORMATION CARD

ATTENTION! ELECTRONICS TECHNICIANS

EARN YOUR
**B.S.E.E.
DEGREE**

THROUGH HOME STUDY

Our New and Highly Effective Advanced-Placement Program for experienced Electronic Technicians grants credit for previous Schooling and Professional Experience, and can greatly reduce the time required to complete Program and reach graduation. No residence schooling required for qualified Electronic Technicians. Through this Special Program you can pull all of the loose ends of your electronics background together and earn your B.S.E.E. Degree. Upgrade your status and pay to the Engineering Level. Advance Rapidly! Many finish in 12 months or less. Students and graduates in all 50 States and throughout the World. Established Over 40 Years! Write for free Descriptive Literature.

**COOK'S INSTITUTE
OF ELECTRONICS ENGINEERING**

**4251 CYPRESS DRIVE
JACKSON, MISSISSIPPI 39212**

CIRCLE 58 ON FREE INFORMATION CARD

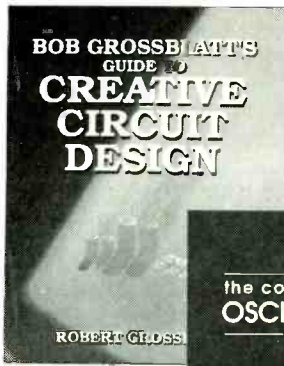

3610 \$28.95

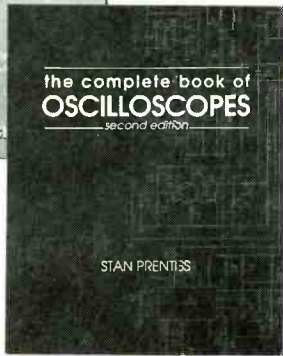

3825 \$26.95

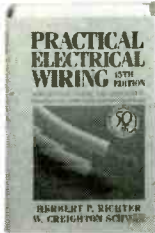
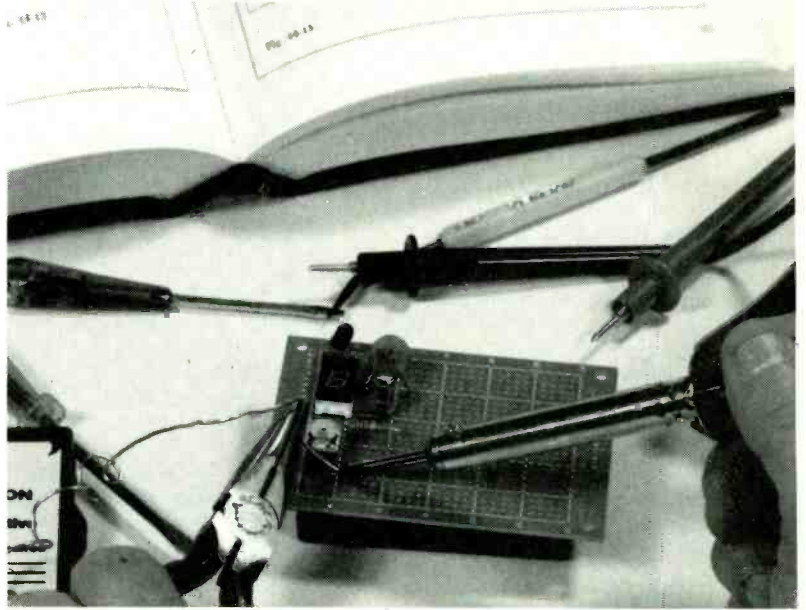

10024-XX \$39.95
Counts as 2



585120 \$12.95

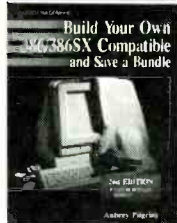

4089P \$18.95



2883P \$18.95
Softcover

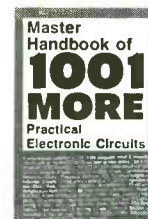

804P-XX \$21.95
Counts as 2/Softcover

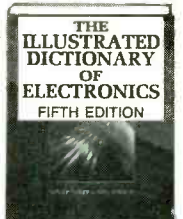

3345P-XX \$26.95
Counts as 2/Softcover

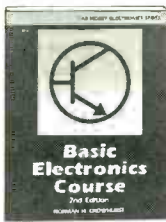

2613P \$17.95
Softcover

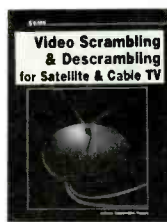

585107-XX \$24.95
Counts as 2



037504 \$39.95



1367P \$29.95
Softcover

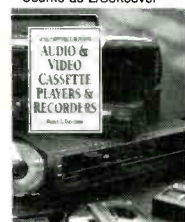

3795-XX \$29.95
Counts as 2

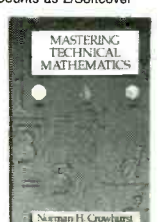

3438 \$39.95

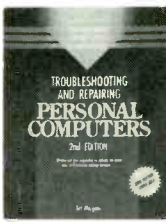

3677-XX \$34.95
Counts as 2

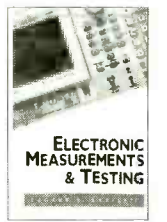

003961-XX \$39.95
Counts as 2

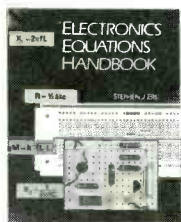

3241P \$16.95
Softcover

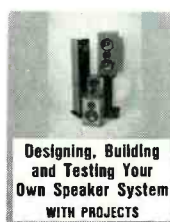

3374P \$16.95
Softcover



3107P \$18.95
Softcover

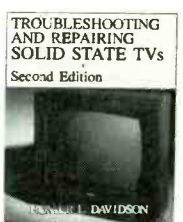

3700-XX \$36.95
Counts as 2

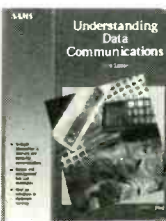

586312-XX \$24.95
Counts as 2



011019-XX \$39.95
Counts as 2



4143 \$22.95



009522-XX \$47.95
Counts as 2

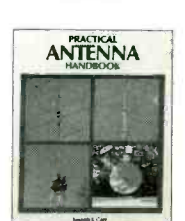

3270-XX \$32.95
Counts as 2

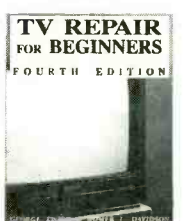

3627P \$19.95
Softcover

AUDIO UPDATE

Two recommendations: A poor man's indoor rotary FM antenna and a rational audiophile publication

LARRY KLEIN

Once upon a time, if you bought an FM tuner or receiver—and took the trouble to read its instruction manual—you would always be warned that if you wanted really good reception a rotary roof-mounted antenna was the only way to go. Obviously, the manual writers were not living in the heart of New York City, where getting the landlord's permission to mount a roof antenna without a rent increase was as difficult as climbing Mount Everest.

In truth, I found that the FM reception situation, at least in Manhattan, was nowhere near as bad as the tuner manuals (and hi-fi magazines) would have you believe. True, certain steel-frame buildings effectively blocked the FM signal in certain locations, and most tuners were no paragons of sensitivity. But if you carefully repositioned your 300-ohm folded dipole flat-line antenna for each station, good-to-adequate reception could be achieved for most stations.

Long before the idea was generally accepted, I thought of using a TV rabbit-ear antenna for FM. In fact, I commissioned the late Herb Friedman to test a dozen or so rabbit ears for FM use and write up the results. As I remember the article, Herb's conclusion was that the more complicated antennas worked no better than the simpler ones.

And so it went for several years until I installed the PMIRA, a poor man's indoor rotary FM antenna in my system. It consists of a two-pole, three-position (or more) switch (rotary, slide, or lever type), and three (or more) flat-line folded dipole antennas of the kind normally supplied with tuners and receivers. The antennas are mounted with two of them at right angles to each other and the third is placed diagonally

with respect to the others. For best results, the antennas should be separated to avoid interaction. At FM frequencies, the capacitances between the switch terminals are low enough to be insignificant.

If you don't want to construct your own FM folded dipole, Radio Shack has one listed for \$3 on page 105 of its 1993 catalog. A \$1.39 two-pole, six-position rotary switch is on page 113. You don't have to use all six positions, of course, but you could try fine-tuning a dipole for your favorite station at one of the extra switch positions.

How well does the antenna work? Fortunately, I own an excellent 15-year-old tuner (the Micro/CPU100) that will provide a direct reading of relative multipath strength and the antenna signal input. The meters on the tuner leave no doubt about the effectiveness of the PMIRA. As I tune through the thirty-odd stations whose call letters are programmed into the tuner's memory, I can see the signal strength and multipath (if any) vary for each. Resetting the switch for optimum signal input and minimal multipath for each station takes but a moment. On some stations, the setting that provides maximum signal strength is not the same as the one that provides minimum multipath. At other times, the meter readings are good, but a different switch setting reduces the background hiss level.

I've used the PMIRA for about 15 years, first in midtown Manhattan and later in the suburbs 30 miles away, and I can attest to its effectiveness in both locations.

If you are using an indoor FM antenna, then 25 feet of 300-ohm flat TV cable converted to folded dipoles and a \$1.39 rotary switch will make a substantial improvement in your FM reception.

A thinking audiophile's magazine

Regular readers of this column should by now be aware of my somewhat jaundiced attitude toward pricey high-end audio equipment. However, I reserve my real annoyance for those audiophile magazines (and their writers) that with a witch's brew of pseudo-science and unabashed subjectivism, tout such equipment to their faithful followers. I'm referring, of course, to magazines such as *Stereophile*, *The Absolute Sound*, and several others with limited circulation, that keep their readers abreast of the latest audio excesses.

All is not lost in the Twilight Zone, however. There is a countervailing force among audiophile magazines that I've not previously mentioned on these pages. I'm referring to *The Audio Critic*, an approximately quarterly publication that, if taken regularly, is an effective antidote to the self-serving silliness of the other audio-buff publications. *The Audio Critic's* editorial attitude—and prose style—is illustrated neatly in a recent piece by its editor, Peter Aczel. He feels that accountability is a major problem among the esoteric audio journals. Subjective reviewers regularly assert that they hear (in a given piece of preferred equipment) improved sound staging, front-to-back depth, width, greater transient definition, and sometimes even improved rhythm and pace. (As to the latter, we know that tape recorders and record players are sometimes off-speed—but amplifiers?) Such judgments are seldom if ever backed up by any rigorous test procedures. Mind you, the supporting tests we rationalists call for are not of the equipment's electrical performance, but rather of the reviewer's ability to demonstrate objectively,

with statistically valid double-blind listening tests, that he really hears what he claims he hears. Over the years, controlled tests—many of which I've written about in these pages—have consistently shown that the subjective reviewing that appears in *Stereophile* and *The Absolute Sound* is essentially unreliable, influenced as it is by price, fads, technical ignorance, and unfettered egos. That is not to say that some preferred piece of equipment might not be very good—if not particularly cost effective.

In contrast to those publications, *The Audio Critic's* reviews are models of rationality, coherence, and technical competence. Measurements from state-of-the-art test equipment are backed up by circuit analysis and evaluation of the construction and parts quality. When TAC's double-blind listening tests reveal an audible difference (and in a lot of electronic audio equipment there just isn't any to be heard), the electrical source of the difference is investigated and discussed. Mysteries are resolved rather than relished.

While equipment reviews are the core of TAC, the magazine also includes excellent in-depth survey articles exploring entire technologies (e.g., CD player design, low-bass reproduction and preamp circuitry). I say without embarrassment that I have learned a lot from them. Such articles are reinforced by no-holds-barred forums whose participants include the foremost names in audio, both academics and manufacturers. For me, the most fun-filled part of the publication is a column called "Hip Boots: Wading Through the Mire of Misinformation in the Audio Press." I'm pleased that editor Aczel has not seen fit to aim his acerbic pen at any of the columns I have written.

A subscription to *The Audio Critic* that includes four consecutive issues starting with the current one (No. 18) costs \$24 in the U.S., Canada, or Mexico. For \$5 extra, issues 16 and 17, chock full of good stuff, will also be sent along with your subscription. Write to The Audio Critic, Dept. RE, P.O. Box 978, Quakertown, PA 18951. You won't be disappointed! **R-E**

HARDWARE HACKER

continued from page 75

continuously generates a reference voltage above the positive supply. Leaving IN1 low leaves the load unpowered. Raising IN1 to a TTL logic one (+2 volts or higher) supplies the boosted voltage to the power MOSFET, turning on the load. With a 5-volt supply, the boosted voltage is around +12 volts total, or around +7 volts above the supply. Higher boost voltages are generated for higher value supplies.

The load power normally stays on until IN1 drops to a logical zero under 0.8 volts. There's also a protection input known as DS1. If DS1 ever gets more than one tenth of a volt below the supply, it automatically shuts things down. You can add a load-sensing resistor of one tenth of an ohm per amp to shut down on any overcurrent, as shown.

Some loads might have large but expected inrush currents. This often happens with incandescent lamps and solenoids. A resistor and capacitor time delay can be added to the current sensing to allow inrush currents but still react to overloads. This simulates the operation of a slow-blow fuse. See the LTC1155 data sheet for details.

Switching times are fast but not stunning. The turn-on time is around half a millisecond. The usual turn-off time is around 32 microseconds.

Note that any simple EXCLUSIVE-OR gate could be used for external fault detection. If the on command is high and your load is low, you will have an output short. If the on command is low and the load is high, you will have an output open. If both are low, you have a normal switch turn-off, and if both are high, you'll have a normal switch turn-on condition.

The standby current when off is a mere 8 microamps, making this ideal for battery-saving applications.

More semiconductor houses

This month we will continue our multi-part resource sidebar listing of semiconductor houses, picking up *Gould* through *NEC*. I have left off some of the more obscure outfits that don't seem too innovative.

General Electric, Intersil, and

41,361

ELECTRONIC COMPONENTS

Whether you order 1 part or all 41,361...MOUSER stocks and...can ship today!!

CALL...
(800) 992-9943

for your
FREE
CATALOG

2401 Hwy 287 N.
Mansfield, TX 76063

MOUSER ELECTRONICS

Sales & Stocking Locations Nationwide

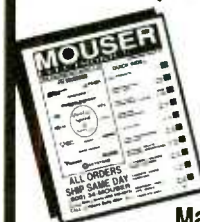

CIRCLE 117 ON FREE INFORMATION CARD

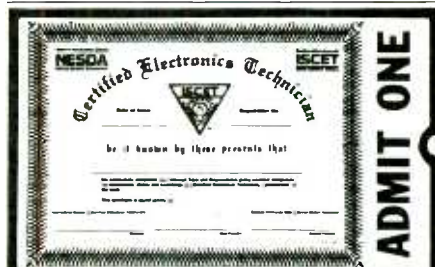

Your Ticket To

SUCCESS

Over 28,000 technicians have gained admittance worldwide as certified professionals. Let your ticket start opening doors for you.

ISCET offers Journeyman certification in Consumer Electronics, Industrial, Medical, Communications, Radar, Computer and Video. For more information, contact the International Society of Certified Electronics Technicians, 2708 West Berry Street, Fort Worth, TX 76109; (817) 921-9101.

Name _____
Address _____
City _____
State _____ Zip _____

Send material about ISCED and becoming certified.

Send one "Study Guide for the Associate Level CET Test." Enclosed is \$10 (inc. postage).

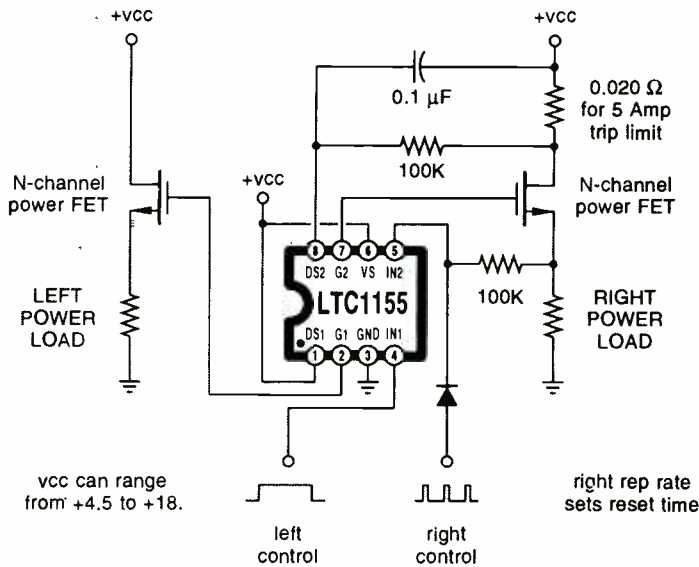

FIG. 5—A DUAL HIGH-SIDE DRIVER. The left side is shown as a simple power relay, while the right side includes "slow blow" current sensing and an automatic circuit breaker reset. Boosted gate voltages are internally generated.

RCA are now part of Harris. A few of their better chips remain available.

Similarly, the Sprague folks have now become Allegro, Amperex has sold out to Philips, and the dregs of Mostek were long ago absorbed into SGS. General Instrument has moved across the country and all their good sound-effects chips fell off the truck on the way. Most of the low-volume power semiconductor houses are now changing their names so fast it is hard to keep up. See PCIM and similar trade journals to find just out who is currently calling themselves what.

Laser repair training bargain

Canon Inc. manufactures the most popular laser printer engines in use today by far. Hewlett-Packard, Apple, QMS, and many of the other major players all use Canon engines in their laser printers.

Of these printers, by far the most popular mid-range units all include the Canon SX engine. And the largest single repair cost on all these machines is cleaning and repair of the SX fusion assemblies. The things that typically goes wrong with SX fusion assemblies are scored or swollen rollers, broken or burned-out quartz heater lamps, worn gears or those with missing teeth, dirty or defective temperature sensors, feed creasing and jamming, or general grunge ac-

cumulation.

Don Thompson of TechniGraphics has long offered the very finest laser-printer repair training. He recently sent me a sample of his new SX Fuser Assembly Master Kit, and has agreed to offer it to **Electronics Now** readers at a special price of \$350.

For the price of one new fusion assembly or one single fusion repair from a typical computer dealer, you get a complete set of all the quality hand tools and supplies required to become a fusion rebuilding expert; a two-hour lucidly detailed videotape; secret insider info on the "tye wrap" spring retainer method; a personal tech help hotline; and replacement parts for just about everything that can go wrong with these units.

Asian sources

I continually get helpline calls for hardware hackers who seek Asian contacts for computers and electronic assemblies and custom work. We have already seen that *Trade Winners* is one possible resource. This is sort of a Hong Kong *Computer Shopper*, only wholesale.

But I may have found the mother lode. There's now a Hong Kong trade-journal publisher by the name of *Asian Sources* who publish seven magazines, one each for computers, electronics, electronic compo-

nents, timepieces, fashion accessories, home products, and "hardwares." The latter is apparently their term for machinery and industrial supplies. Yes, they are all printed in English.

These cost \$70 each per year via surface mail. But they do offer free samples on a one-sample-per-request basis. Per their bingo cards.

New tech lit

From Dallas Semiconductor, there's a fat new 1993 Product Data Book. It's full of exciting, innovative, and very useful hacker chips. Mostly timers, clocks, non-volatile memory, smart sockets, telephone, and security stuff.

Through Cherry Semiconductor, there's a new data book on automotive, sensor, motor controlling, and power-supply circuits. And Reticon has a *Solid State Camera Products* data book.

The *Industrial Marketplace* is a tabloid shopper with lots of outstanding surplus offerings and auction listings. Mostly mechanical and machine shop stuff, but definitely some electronics. I get the impression that this is the wholesale surplus insider's magazine.

Another interesting and readable surplus shopper magazine is the *ASD/AMD TradeNews*. But it does not strongly emphasize electronics.

Replica kale is newly offered by *Garden Way Products*.

Free samples of their new Al-InGaP lamps are available through *Hewlett Packard*. These are incredibly bright LED's visible in direct sunlight, and intended for eventual use as auto tail lights and turn signals. A detailed discussion of this new technology appears in the current issue of *Speleonics*.

I've recently posted a thorough and complete list of inventor's resources to PSRT as #520 INVENTOR.PS. Also see #477 NOPATENT.PS.

Sorry for the inexcusable delays, but I've at long last gotten my new *Incredible Secret Money Machine II* backlog worked off. I am currently shipping autographed copies of this newly revised guide to forming your own small-scale tech, craft, or artistic venture. More details per my nearby *Synergetics* ad. **R-E**

DRAWING BOARD

Our descrambler starts to take shape.

ROBERT GROSSBLATT

For reasons that I've never understood, even people who manage to build circuits of mind boggling complexity turn green at the gills when it comes to designing circuits that can manipulate baseband video. Maybe it's due to the complexity of the signal or the speed of some of its components (in the single-digit microsecond range), but lots of very talented circuit designers tend to shy away from anything but the most basic video circuitry.

Building a circuit that can make sense out of SSAVI-encoded signals isn't simple, but it's not impossible, either. Best of all, it can teach you a tremendous amount about basic video, too. We've reached the point in this subject where we start turning to hardware. If you look over the block diagram in Fig. 1, you'll see that the circuit we'll need is no more complex than any of the others we've put together over the years.

The final thing we talked about last month was a reset pulse that's needed to initialize the various line counters that will be part of the SSAVI descrambler. We need to find something in the scrambled signal that's stable enough to use as a reset for our digital circuitry.

Remember that everything in the vertical interval is sent "in the clear." One of the components there is vertical sync—an ideal candidate for generating a reset pulse. When you look at scrambled video on a scope or waveform monitor, you may wonder how anything can be picked off the signal. (Incidentally, you stand a much better chance of successfully viewing the scrambled signal if you have a dual-channel scope. Just feed standard video into one channel, use that for the trigger, and view the scrambled

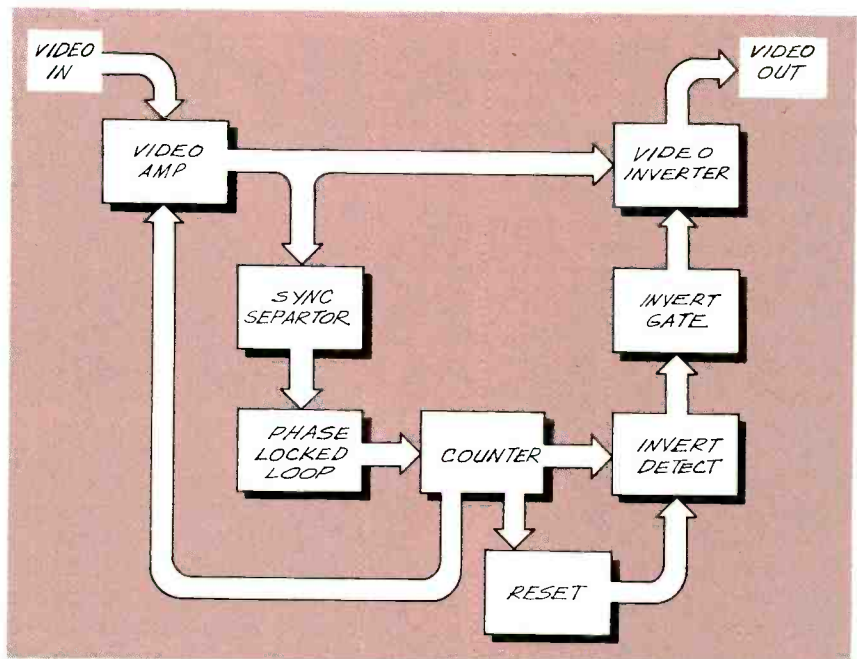

FIG. 1—BLOCK DIAGRAM OF OUR SSAVI DESCRAMBLER. The individual sections of the circuit are no more complex than other circuits we've put together over the years.

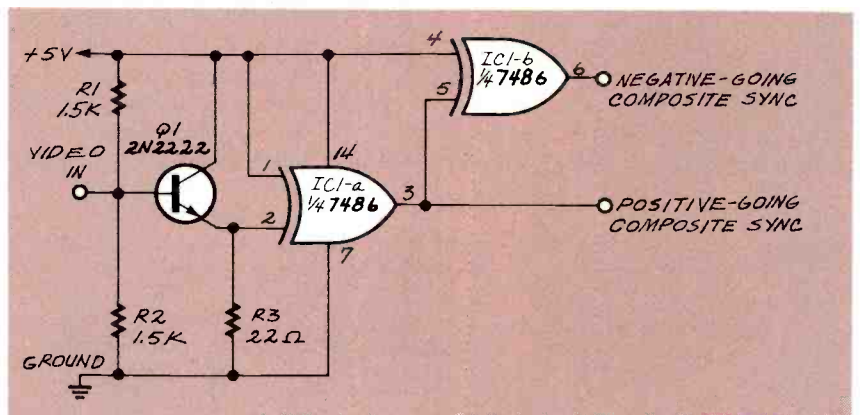

FIG. 2—THIS CIRCUIT WILL TAKE VIDEO in at one end and give you positive- and negative-going composite sync signals at the other end.

stuff on the other channel of the scope.)

Scrambled video may look like a mess, but even broadcast video that's sent in the clear is incredibly jittery. It's a tribute to TV designers and the video standard in general, that the TV set can lock onto any-

thing that comes in over the airwaves.

If you tune your TV to a scrambled signal, you'll note that although the picture is messed up, the screen always shows a full frame. That's because, even though horizontal sync has been altered by

the cable company, vertical sync can still be recognized by the circuitry in your TV.

The first piece of hardware we built some months ago was a simple demonstration circuit that enabled you to mess up the horizontal sync signal. I hope you haven't thrown that away just yet because we can use part of it now. The first thing we have to do to the video signal to descramble it is separate the sync from the picture.

The circuit shown in Fig. 2 will take video in at one end and give you two versions of the composite sync part of the signal out the other end: positive- and negative-going. The transistor is working as a simple buffer and, by adjusting the video level at its output, we can have the incoming negative sync fall below the high threshold of the TTL EXCLUSIVE-OR (XOR) gate. The first gate produces the composite sync and the second gate works as a simple inverter.

If this is the first time you've seen this circuit, you can get a full description of it by going back to the November 1992 column where it appeared for the first time. There are other ways to separate sync, but this one has the advantage of giving you an output that swings close to the supply rails, has a very low noise component, and is at TTL logic levels, which makes it much more reliable for feeding the digital circuits we'll be designing for the rest of the descrambler.

While we're looking at the composite sync signal, this is a good

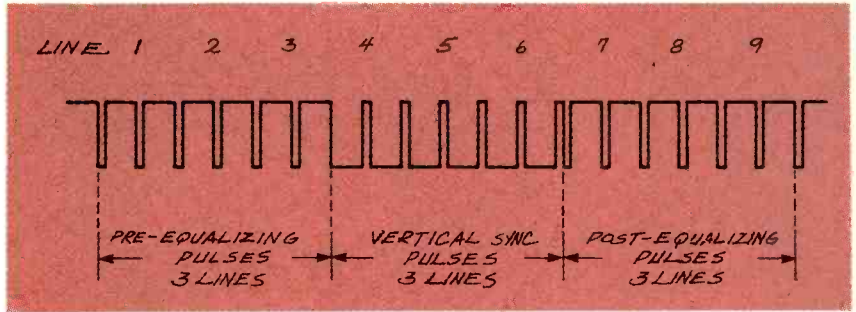

FIG. 3—COMPOSITE SYNC WAVEFORM. Vertical sync is the most negative part of composite sync.

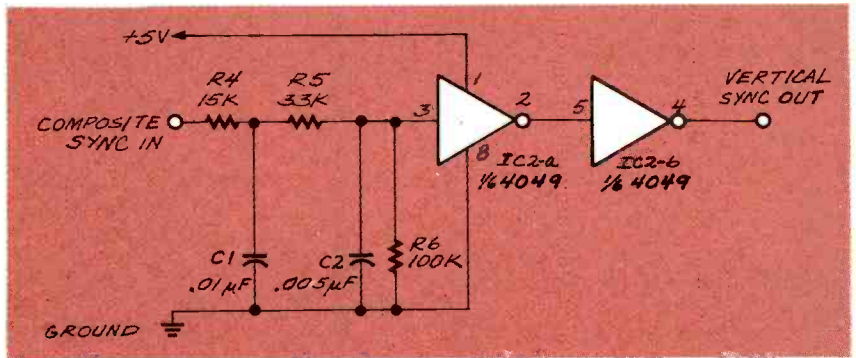

FIG. 4—TO ISOLATE VERTICAL SYNC, we need a simple low-pass filter like this.

time to work out the details of the reset circuit since it has to isolate vertical sync from the composite sync signal. The way to do that should be obvious when you look at Fig. 3, the composite sync waveform. Just as it's supposed to be, vertical sync is the most negative part of composite sync. To isolate the vertical sync, we need a simple low-pass filter; a suitable one is shown in Fig. 4.

The two gates after the filter clean up the sloppy waveform produced by the R-C circuit. You'll notice that CMOS 4049 inverters

square up the shoulders of the waveform. The low-pass filter (or vertical integrator, as it's sometimes called) is being fed with a positive-going version of composite sync and, since it's going through two inverters, it's producing a positive-going vertical sync pulse at the output of the circuit.

That's necessary because we a positive-going vertical sync for the rest of the circuit. As with most things electronic, there are several ways to do the same job, but bear with me until we've gone through the whole design before changing

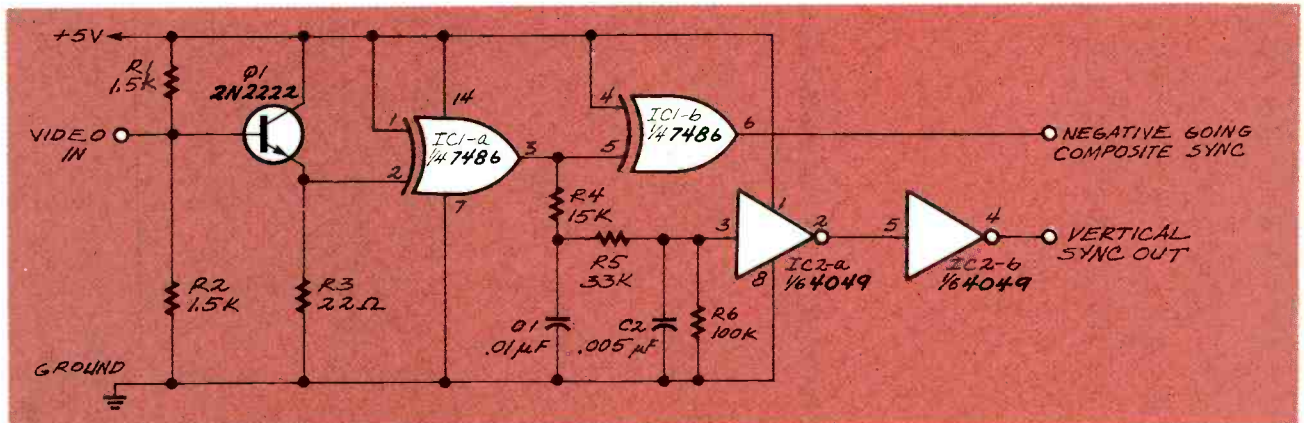

FIG. 5—THE FINISHED PIECES OF OUR DESCRAMBLER can be put together as shown here. Video goes in at one end and we're able to isolate the sync pulses at the other end.

things around. Once you understand the circuit in its entirety, you can start modifying it to your heart's content.

Even though we haven't completed the design of the descrambler yet, the pieces we've finished can be put together as shown in Fig. 5 to produce some interesting and extremely informative waveforms. Video goes in at one end and we're able to isolate the sync pulses at the other end. I leave it to you to imagine what a bit of creative gating can do—especially if you use these signals to control the switches in a 4066 as we did some months ago in the demonstration circuit.

Now that we have vertical sync isolated, the next job to do (and the most critical for the descrambler) is to come up with a way of producing horizontal sync. That is obviously more difficult because we know that it won't be present all the time in the received video signal. As a matter of fact, it's a lot better if we operate under the assumption that it's never there at all.

Generating horizontal sync pulses is, in and of itself, a fairly simple business. We know the pulse width and frequency we need for it, but we're missing the starting point. There has to be some reference somewhere in the signal that we can identify so we know how to establish the correct time relationship between our artificially generated horizontal sync pulses and the received video signal.

The answer to this is the same one we've found all along—again don't forget that video is sent in the clear during the vertical interval. If you look there you'll find 26 lines of normal video with normal horizontal sync pulses. That gives us 26 lines of reference signals. Our job is to design a circuit that will continue to produce horizontal sync at the same rate and at the same interval for the rest of the frame.

Because there are 260 or so lines in each frame of video, we'll have a reference available for about ten percent of the time. That's more than enough of a reference for a well-designed phase-locked loop circuit to maintain the correct repetition rate for horizontal sync through-

BIG PROFITS IN VIDEO REPAIR!

WORK FROM HOME—EARN \$85 HR!

With the tens of millions of VCRs and Camcorders in use, there currently is a **serious shortage** of trained techs to perform cleaning and repair jobs on these popular devices... Learn how you can start your own highly profitable, **Home-Based** video servicing business... And since up to 95% of all VCR and Camcorder malfunctions are due to a simple **mechanical** or **electro-mechanical** failure, you need not spend months or even years of complicated study before starting **paid, professional service work!** Let Viejo's Training Program show you how!



Train at Home in your Spare Time!

1-800-537-0589

or mail coupon today!

VIEJO PUBLICATIONS, INC.

4470-107 Sunset Blvd., Suite 600
Dept. VK Los Angeles, CA 90027

Yes! **Rush** me your **FREE OPPORTUNITY KIT** today!
(Check appropriate box)

VCR Repair
 Camcorder Repair
 Advanced VCR Repair
 Fax Machine Repair

Name _____

Address _____

City/State _____ Zip _____

Dept. RI _____

CIRCLE 184 ON FREE INFORMATION CARD

out the entire frame. As we pointed out some months ago, the colorburst signal is present for only 2.5 microseconds, and it serves as a reference for 53 microseconds of picture on each video line. That means the color reference is around for less than four percent of the time. Since we'll have a reference for more than twice that time for horizontal sync, we shouldn't have any problems.

The key to getting good video from a SSAVI-encoded signal is the design of the phase-locked loop that will generate the missing horizontal sync pulses and put them on each video line at exactly the right time. Next month we'll see what has to be done to design that part of the circuit.

There's some math involved and we'll be using a 4046 CMOS phase-locked loop as the heart of the circuit. Get yourself a data sheet on the chip because using it is a bit more involved than the standard gates and counters in the rest of the circuit. **R-E**

BOOT YOUR PC REMOTELY

continued from page 59

Figure 5-a shows the LED circuit. Inverters IC6-c and IC6-d drive the LED's to provide the necessary sink current. (Note that IC6-c also connects to the parallel-port driver circuit, in which it drives an optoisolator.) The LED's provide several types of status information, summarized in Table 2.

Figure 5-b shows the tone-generator circuit, which is driven by PA5 of the microcontroller. The tone generator is a simple monostable multivibrator; R21 and C14 form an RC time constant circuit that causes IC7 to oscillate at about 1 kHz. Op-amp IC2-b then drives the speaker. The microcontroller can create different sounds by modulating the beep frequency. During normal operation, you will hear the sounds listed in Table 3.

Figure 5-c shows the relay-driver circuit. Transistor Q1 turns on whenever PA4 goes high; diode D12 protects transistor Q1 from voltage spikes that could occur when the coil is de-energized.

Next time

We're out of space in this article. Next time we'll complete the circuit description and go on to build a Ring-Thing. Meanwhile, you might want to order parts and software. See you then! **R-E**



THE BURNING MUST STOP NOW!



The world's rain forests are burning. And a wealth of wildlife is trapped in the fire's path.

Rain forests occupy just 2% of the earth's surface. Yet, these rain forests are home to half of the planet's tree, plant and wildlife species. Tragically, 96,000 acres of rain forest are burned every day.

You can help stop this senseless destruction. Right now you can join The National Arbor Day Foundation, the world's largest tree-planting environmental organization, and support Rain Forest Rescue.

When you join, you will help establish natural rain forest barriers to stop further burning and support on-site conservation management plans to protect threatened forests.

Each and every second, a rain forest area the size of a football field goes up in smoke. You'd better call now.



 **The National Arbor Day Foundation**

**Call Rain Forest Rescue NOW.
1-800-255-5500**

WORLD BAND RECEIVER

continued from page 68

spring at one end keeps the cord in tension over the pulley. A screw in the edge of the pulley approximately 120° away from the slots will anchor the other end of the spring. Fasten the pulley to the tuner shaft with a suitable adapter.

A pattern for the precision dial is given here. It can be photocopied from the the magazine page and cemented to the front face of the dial pulley as shown in Fig. 13. Cut a suitable bezel from 1/8-inch sheet plastic to form an appropriate frame for the dial window. The inside of the bezel should be cut and filed to match the 1 1/2 × 1/2-inch cut-out in the front panel, but there are no restrictions on the outside dimensions of the bezel. Be sure the bezel sidewalls are wide enough to permit it to be fastened to the front panel with screws and nuts.

Paint the dial window bezel before assembling it to the front panel. In the prototype, the clear plastic was painted black to match the color of the knobs.

Scribe a vertical line on the piece of clear plastic to be used as a window over the rotary dial and behind the slot cut in the front panel. With a sharp black felt-tip pen carefully trace over the scribed line so that it will appear as a distinct hair line to serve as the cursor.

Place the painted bezel on the outside of the front panel and the scribed window on the inside (with the cutout window in the front panel between them) and assemble them with screws and nuts. Wind on the nylon drive cord as shown in Fig. 13 and fasten it to the spring.

Power supply

The prototype SWX6 receiver was powered by a regulated 12-volt power supply. The receiver draws about 75 milliamperes, so any source of 12 volts, including batteries, at that current level can be used. Provision must be made, however to obtain the 5 volts DC to power the variable frequency oscillator.

Enclosure finishing

Assemble the three principal circuit boards to the base plate of the enclosure with No.4-40 machine screws and two No. 4-40 nuts used as spacers in the positions shown in the photograph Fig.5.

Complete all wiring. Make the connection from the antenna jack J1 to the wiper of switch S1-a with RG-174/U coaxial cable, and make all connections from the six terminals of switch S1-a to the six filters (detailed in Table 2) with enamel-coated magnet wire. Then make all connections from the output side of the filters to the contacts of S1-b with RG-174/U coaxial cable. Also, connect the S1-b wiper contacts to capacitor C15 with RG-174/U coaxial cable.

Make the following connections with insulated wire:

- Five volts to the wiper of S1-c
- Six terminals of S1-c to each of the oscillators shown in Fig. 4
- The six output connections from the oscillators S1-d

Make the following connections with RG-174/U coaxial cable:

- Wiper of switch S1-d to C14
- Electrolytic capacitor C41 to speaker/headphone jack J2

Enclosure assembly

Mount the front and back panels on the base panel with angles, nuts and bolts. The side panels should be assembled with angles set so they are concealed behind the left and right edges of the front and back panels, under the left and right edges of the top panel, and over the side edges of the baseplate.

In the prototype, dry-transfer labels were applied to identify the manual controls. A separate circular plastic band switch plate was used to identify the band positions on the multi-deck switch. (This plate can be easily changed if you want to change the band positions or frequencies.) Clear lacquer was applied over the dry labels to protect them. Install four rubber feet on the bottom of the base plate with sheet metal screws to prevent the exposed screw heads from scratching the table on which the receiver is located.

R-E

COMPUTER CONNECTIONS

Desktop Video

JEFF HOLTZMAN

Information—all information—is going digital. That's what the multimedia revolution is all about. Digital information gives us *media integration* (Apple's phrase), a rich way of stimulating the human sensory systems. Cost-effective PC's and Macs now do a pretty good job of displaying text and graphics. Better resolution and color depth are still required, but those are incremental improvements to fairly mature, cost-effective, technologies. Not so with audio and video (A/V). Adding A/V to the computing environment promises breathtaking new ways of computer-based work—and play. But these categories are anything but mature.

Imagine you've been imprisoned in a 10' × 10' × 10' cell, solitary, dark, silent. Then imagine the addition of a window, through which you can view, but not interact with, the outside world. That's today's situation. Tomorrow your captors will install pipelines carrying news, sports, weather, and entertainment. And remote-control devices for you to manipulate and interact with scenes far beyond your little cell.

Bringing A/V media to the desktop has gone slowly because the technology is difficult and expensive, and performance has been lacking. However, things are improving. This time and next we'll focus on some of the issues behind bringing video to the desktop computer; a future column will discuss audio issues.

Analog and digital

There are several ways to integrate video media with a computer. The traditional approach was to use analog production and distribution media, and to use the computer to control the analog devices. For ex-

ample, laserdisc and professional video tape recorders and players store information in analog format, but typically have RS-232 ports for command and control. The computer requests user input and then instructs the disc or tape player to branch to a new location, depending on the user's response.

Many educational and corporate training exercises have been built around that type of system. However, there are several problems with it. For one, production costs are high: \$100,000–\$250,000—and up. In addition, analog editing is slow because tape doesn't provide random access. Further, quality degrades each time an analog copy is made. Analog systems are also expensive and touchy to maintain. Digital systems, by contrast, offer perfect duplication, random access, and incredible editing and special-effects possibilities through digital signal processing. Costs are still high, but trends in semiconductor

and permanent storage ensure that it won't be long before desktop A/V is taken for granted.

Clearly, digital is the way to go. The problem is the tremendous amount of data involved. A few simple calculations illustrate the point. Assume that the basic requirement is broadcast quality video (BQV) with a resolution of about 640 × 480, and 24 bits of color per pixel (required for lifelike imaging). One such frame would require 7,372,800 bits. U.S. broadcast standards require 30 frames per second (vs. 25 f/s in Europe, and 24 f/s for film); to deliver one second of video at 30 f/s would require 221,184,000 bits. In other words, to deliver a continuous stream of uncompressed digital video would require 221 Megabits per second (Mbps)—without audio! Today's leading network protocols, Ethernet and Token Ring, run at paltry rates of 10 and 16 Mbps, respectively. The emerging optical Fiber Distributed Data Interface (FDDI) and its first cousin, Copper Distributed Data Interface (CDDI), run at 100 Mbps—still less than half of what would be required to move uncompressed digital video data around!

Then consider the storage problem. One frame of video consumes $640 \times 480 \times 24 \div 8 = 921,600$ bytes. A CD-ROM disc holds about 650 megabytes, or 705 frames. At 30 f/s, that's about 23 seconds of video. (Even today's short attention-span audience would find that a bit minimalist!) Also bear in mind that you'd still have to get data off the CD at 221 Mbps—except that the data transfer rate of a standard CD drive is 150 kilobytes/s, or 1.2 Mbps. And we still haven't accounted for audio, text data, and just plain overhead!

The only solution is compression.



FIG. 1—ZEOS' \$600 Palmtop PC runs for ten hours off two AA cells, has built-in applications, and the smallest usable keyboard, screen, and overall size on the market.

Problem is, when it comes to compression, a rose is not a rose is not a rose. There are half a dozen fairly well supported and open video compression standards, perhaps four times as many proprietary schemes, and more of both coming. There are hardware solutions and software solutions. The typical hardware solution is expensive, costing nearly as much—or even more, in these days of precipitous price declines—as the system that hosts it. The software solutions trade performance for cost. During the next few months, we'll examine some of the major standards, technologies and products. We'll start with one of the more robust, Intel's Digital Video Interactive.

Look, touch, and feel

DVI is a technology originally developed by RCA and now owned and marketed by Intel. (IBM also comarkets the ActionMedia DVI board set.) The DVI designers worked backward from available media limitations by asking how to get something approaching BQV from a CD-ROM with storage of 650 MB and a data-transfer rate of 150 kB/s. Notice first that 30 f/s divides neatly into 150 kB/s, giving 5KB/frame of video. Second, DVI developers reduced frame size slightly, to 512 × 480. Even at that size, however, a frame still consumes 737,280 bytes of data. Dividing that by 5K gives a compression ratio of 147:1. In other words, while recording (or possibly later), every 1/30th of a second, a chunk of data would have to be reduced by a factor of 147. And the same during playback. Add audio and control data, and the ratio increases to about 150:1.

That may not seem like much, but consider this. If you've ever used PKZIP or Stacker, you can get a feel for compression ratios. That type of program typically provides a mere 2:1 compression ratio, which is typical of *loss/less* compression techniques, in which every bit of data can be restored to its original state. By contrast, *lossy* compression techniques achieve much higher compression ratios, but at the loss of some data. Lossless compression is important for text and ac-

counting data; lossy is acceptable for imaging, although some applications (e.g., medical imaging) may require lossless techniques. Doing either in real time, at video data rates, requires high-powered digital equipment.

DVI comes in two flavors: Production Level Video (PLV) and Real Time Video (RTV). To get PLV, you have to send a tape to a special Intel-authorized production center, where an array of 64 transputers operating in parallel compress the video data down to an average of 5K per frame. However, resolution is halved, to 256 × 240, and the compression service costs \$250 per minute of finished video. At that level, for example, a one-hour training film would cost \$15,000 for compression alone. RTV can be compressed on the fly by the DVI board set, but resolution drops to 128 × 120. The DVI boards can play back both DVI and RTV in real time, without jerkiness, but both the loss of resolution and the lossy compression are noticeable. Nonetheless, DVI works, and it works well enough for industrial and business use. High cost and mediocre quality make it iffy for the general consumer market.

The cost is \$2000 for the playback board, and an additional \$900 for an RTV capture board. DVI boards are also available for high-end Macintoshes. For a while, Intel talked about introducing a lower-cost version of the DVI chip set, but recently dropped that in favor of a software-only approach, called Soft RTV, à la Apple's QuickTime and Microsoft's Video for Windows. Intel may also be planning a very low cost chip that would go on the moth-

erboard (or even on the same substrate as a CPU) and provide mass-market DVI decompression. With a chip of that nature as part of the architecture of every PC (either built-in or as part of a low-cost add-on), DVI would command the video decompression market. DVI is not the ultimate solution—frame resolution is limited, and compression costs are much too high and inconvenient—but for now, it's the best we've got.

One other DVI characteristic worth mentioning: the main compression chip is programmable, which means that it can support other compression algorithms. For more information, you should contact IBM or Intel, and see *Multimedia Applications Development*, copublished by Intel and McGraw-Hill. The book provides a good introduction to DVI technology and creating DVI productions.

Technically similar, but less well supported hardware approaches are available from several vendors, including VideoLogic (for PC's), and Radius and RasterOps (for Macintoshes).

Next time we'll discuss compression algorithms and software-only approaches, including Apple's QuickTime and Microsoft's newly introduced Video for Windows. Competition in this area is intense, fascinating, and fun—stay tuned!

Product watch

When it comes to portable computers, most of the industry's attention is focused on superfast, superlight Windows-capable 386- and 486-based machines. Bucking that trend is the new Palmtop PC (PPC) from Zeos Intl. This \$600 device makes a clear tradeoff, giving up CPU power, screen resolution, and storage capacity for overall size, weight, and battery life. If you want something Windows capable, forget it. Nor would you want the PPC as your only machine. But if you're looking for a versatile machine for traveling, going to meetings, or taking classroom notes, the PPC is a very hot ticket.

Basic stats include overall dimensions of 9.5" × 4.5" × 1", weight of 1.3 lb., a V30 (8088-compatible)

Resources

- Palmtop PC (\$595), Zeos International, Ltd., (800) 423-5891.

CIRCLE 41 ON FREE INFORMATION CARD

- IBM Multimedia Sales and Information, (800) 426-9402.
- Intel Multimedia Products, (609) 275-8080.
- *Multimedia Applications Development Using DVI Technology* (\$39.95), Mark J. Bunzel and Sandra K. Morris, Intel/McGraw-Hill, 1992.

CPU running at 4.77 or 7.14 MHz, a CGA-level display, 1.5 MB of ROM, 1 MB of RAM, a serial port, a parallel port, and two PCMCIA slots. The screen measures a squashed 6.8" x 2.6", and is a nonbacklit LCD type. Though no match for a backlit, VGA screen, readability is quite good in decent light; contrast is much better than first-generation LCD's (e.g., the venerable Toshiba T1000).

The keyboard is compressed, but you can touch-type on it. The function keys are smaller than the regular keys, the spacebar is very narrow (about half normal width), and the On/Off switch is just above the BackSpace key, which makes it easy to turn the machine off inadvertently. However, the PPC has an auto-resume feature that instantly returns you to wherever you were the next time you power up. And speaking of power: *The PPC runs as long as ten hours on two standard AA cells.* It also has a lithium backup battery that allows you to change the main cells without losing memory contents.

The ROM contains DOS 5.0, Microsoft Works 2.0, and several personal management utilities, including a file manager, a daily planner, a to-do list, a card file, a calculator, and several others. Works is quite nice; it contains word processor, spreadsheet, database, and telecommunications modules, all of which are good enough for small, on-the-road jobs. The DOS implementation is incomplete, containing only a very limited subset of commands: Format, Doskey, Xcopy, Label, Print, Keyb, Attrib, and a special communications program, Interserve.

Interserve is intended to be a LapLink work-alike, but it lacks. (LapLink provides a fast, easy way of transferring files over serial or parallel links. One of its nicest features is the ability to clone itself across the wire, so you only need a copy on one machine to get started.) Interserve provides a similar capability, but it doesn't work very well. I couldn't get Interserve to clone itself without rebooting my desktop machine with no CONFIG.SYS or AUTOEXEC.BAT. Several very uninformative error mes-

sages aggravated the situation. In addition, it is necessary to load a device driver on one machine. You can't do it on the PPC (because CONFIG.SYS is ROM-based), so you have to do it on the desktop. That can be a major pain in the neck. I ended up copying LapLink over, even though it uses almost 100K of RAM.

The basic machine includes 1 MB of RAM, partitioned as 640K of conventional memory and a 384K battery-backed RAM drive (E). You can also add RAM via the PCMCIA slots; ZEOS sells 0.5, 1.0, and 2.0 MB cards for about \$150, \$250, and \$450, respectively, and a 9600/2400 fax/modem card for \$250. The PPC has no capability for floppy or hard disk drive, but external solutions that work off the parallel port are available as accessories. The PCMCIA market in general is about to explode, so be on the lookout for lots of interesting new products.

Mechanically, the screen swivels through about 160 degrees, so obtaining a good viewing angle is easy. A snap-out port cover conceals the nonstandard serial and parallel connectors, accessed by special cables. The PPC comes with the port-adaptor cables, a DC power adapter, a padded carrying case, and a one-volume user's manual.

In spite of my frustration with Interserve, I really like the PPC. It is by far the smallest usable machine on the market; it is what earlier attempts by Atari and Poquet strove to be and failed. It won't do Windows, but it will last a cross-country flight. Cost is an issue. Adding a couple of megabytes brings the total over \$1000, where low-end laptops with better screens and more storage can be had. However, those machines are larger and battery life is nowhere near that of the PPC.

The PPC represents a preemptive strike by ZEOS on the fledgling pen-input market. It will be interesting to see how PPC stacks up against the units coming from Apple, Sharp, and others. We'll keep you posted.

News Bits

Starlight Networks has introduced a network video server that

claims to be able to serve 20 simultaneous video streams on Ethernet (coax and twisted pair), and that supports DVI, JPEG, MPEG, and AVI formats. IBM has committed \$100 million to create a new company that will use cable-TV data channels to deliver on-demand video and data to business and eventually homes.

Sony finally introduced its long-awaited "Bookman," now officially known as the Multimedia CD-ROM Player. The device has a 5" screen, miniature keyboard, and ability to connect to a TV and printer. It plays audio CD's, and special multimedia titles. Microsoft is supplying the authoring tool, a version of the Multimedia Viewer. The new Sony joins Philips' CD-I, Tandy's VIS, and Commodore's CDTV as yet another CD-based mass-market multimedia machine, all of which are seeking market share and consumer dollars. This holiday season should provide first indications of which of these new technologies will survive. **R-E**

Try the
**Electronics
NOW**[®]

bulletin board
system

(RE-BBS)
516-293-2283

The more you use it the more
useful it becomes.

We support 1200 and 2400 baud
operation.

Parameters: 8N1 (8 data bits, no
parity, 1 stop bit) or 7E1 (7 data
bits, even parity, 1 stop bit).

Add yourself to our user files to
increase your access.

Communicate with other R-E
readers.

Leave your comments on R-E with
the SYSOP.

RE-BBS
516-293-2283

POWER SWITCH

continued from page 44

foil patterns for both. Figure 2 shows the parts-placement diagram for the board that contains IC1, and Fig. 3 shows the one containing MOD1. The Parts List contains a listing of all parts for both boards—simply use only the parts shown on each board. Note that the PC board shown in Fig. 2 requires that a trace be cut and that two parts (C8 and R9) be tack-soldered to the back of the board. The procedures are detailed in Fig. 2.

When installing triac TR1, place it with its metal side fac-

PARTS LIST

All resistors are ¼-watt, 5%, unless otherwise noted.

- R1–R3—47,000 ohms
- R4—1.2 megohms
- R5—680 ohms
- R6—150 ohms
- R7—2000 ohms, ½-watt
- R8—4700 ohms, 2 watts
- R9—1 megohm
- R10—3 megohms

Capacitors

- C1, C9—0.001 µF, ceramic
- C2, C4, C5—1 µF, tantalum electrolytic
- C3—0.1 µF, ceramic
- C6—47 µF, tantalum electrolytic
- C7—10 µF, 50 volts, electrolytic
- C8—0.01 µF, ceramic

Semiconductors

- IC1—MC3373 infrared amplifier/detector (Motorola)
- IC2—MC74HC74 D-type flip-flop
- IC3—MOC3011 optocoupler (Motorola)
- D1—MRD821 infrared detector diode (Motorola)
- D2—1N4733 5-volt Zener diode
- D3—1N4003 diode
- TR1—2N6071A triac
- MOD1—GP1U52X IR module (available from Radio Shack, part number 276-137)

Miscellaneous: PC board, heat-shrink tubing, wire, solder, etc.

Note: A kit for the infrared receiver (the one containing IC1) is available for \$12.95 from DC Electronics, P.O. Box 3203, Scottsdale, AZ 85271-3203. Call (800) 423-0070 or (602) 945-7736.

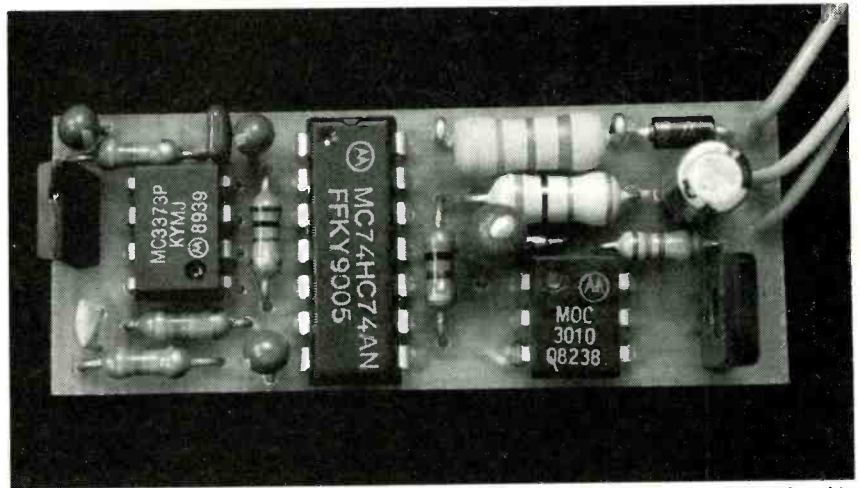

FIG. 4—FINISHED IR SWITCH. This one contains IC1 and D1; if those parts are hard to find, you can build the one shown in Fig. 5.

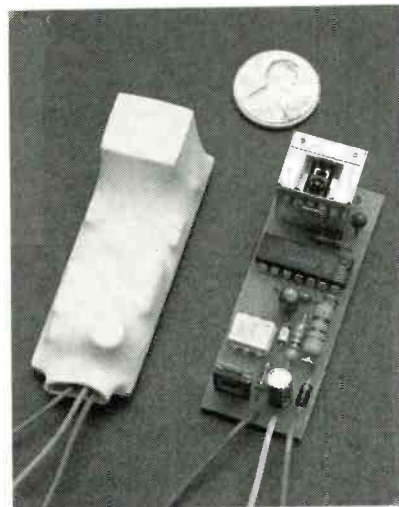

FIG. 5—THIS IR SWITCH uses an IR module instead of IC1 and D1. It's shown here with and without heat-shrink tubing. The IR signal passes right through the white heat-shrink tubing.

ing away from board, and place the side of the photodiode (D1) with the dot on it so that is also faces away from the board—in other words, the dot must face the received signal.

The finished units are so compact that an enclosure is not necessary, although they should be properly insulated. A large-diameter piece of heat-shrink tubing can be used to enclose the entire board. That method permits the whole assembly to be placed inside an electrical switch box, an outlet box, or even a wall. The author's friend used double-sided tape to secure the units to overhead rail lamps throughout his house, making it very easy to turn the

lights on and off by remote control. Figure 4 shows a finished board containing IC1, and Fig. 5 shows one with the IR module, with and without heat-shrink tubing. Note that the IR signal passes right through the white heat-shrink tubing.

Last word

To use the unit, point a TV or VCR remote control at the IR detector and push any button on the remote. Be sure to release the button immediately, otherwise you will turn off the appliance if you exceed the built-in delay of the receiver. You can use the "0" key by itself to avoid having your TV or VCR respond to the signal—or any other key if the "0" button has some specific function assigned to it.

A word of caution: If you ever have to service the appliance that's plugged into this device, be sure to unplug or disconnect the appliance from this device rather than just turning it off with the remote. The reason is because this circuit switches the neutral AC lead (white) rather than the "hot" lead (black). Because the circuit operates in that way, an AC voltage is always present inside a plugged-in appliance.

The number of applications for this circuit is virtually infinite. Aside from turning lights on and off, it can also turn older TV sets on and off. By connecting a relay to the output you can control just about anything.

R-E

BUYER'S MART

FOR SALE

TUBES. "oldest," "latest." Parts and schematics. SASE for lists. **STEINMETZ**, 7519 Maplewood Ave., Hammond, IN 46324 RE.

CABLE TV converters/descramblers! Zenith, Tocom, Jerrold, Scientific Atlanta, etc. At hand is quality, warranty, and free catalog. **DAZYTRONICS**, PO Box 408, Pikeville, TN 37367. Call now! 1 (800) 841-0278.

TUBES, new, up to 90% off, SASE, **KIRBY**, 298 West Carmel Drive, Carmel, IN 46032.

T.V. notch filters and bullet stopper, free brochure. **MICRO THINC**, Box 63/6025, Margate, FL 33063. (305) 752-9202.

ENGINEERING software and hardware, PC/MSDOS. Circuit design and drawing, PCB layout, FFT analysis, mathematics, circuit analysis, etc. Data acquisition, generation, I/O PCB's, etc. Call or write for free catalog. (614) 491-0832, **BSOFT SOFTWARE, INC.**, 444 Colton Rd., Columbus, OH 43207.

CABLE TV Equipment. Most type available. Special: Oak M35B \$39.95. No catalog. COD orders only. 1 (800) 822-9955.

CLASSIFIED AD ORDER FORM

To run your own classified ad, put one word on each of the lines below and send this form along with your check to:

Electronics Now Classified Ads, 500-B Bi-County Boulevard, Farmingdale, NY 11735

PLEASE INDICATE in which category of classified advertising you wish your ad to appear. For special headings, there is a surcharge of \$25.00.

() Plans/Kits () Business Opportunities () For Sale
() Education/Instruction () Wanted () Satellite Television
() _____

Special Category: \$25.00

PLEASE PRINT EACH WORD SEPARATELY, IN BLOCK LETTERS.

(No refunds or credits for typesetting errors can be made unless you clearly print or type your copy.) Rates indicated are for standard style classified ads only. See below for additional charges for special ads. **Minimum: 15 words.**

1	2	3	4	5
6	7	8	9	10
11	12	13	14	15 (\$46.50)
16 (\$49.60)	17 (\$52.70)	18 (\$55.80)	19 (\$58.90)	20 (\$62.00)
21 (\$65.10)	22 (\$68.20)	23 (\$71.30)	24 (\$74.40)	25 (\$77.50)
26 (\$80.60)	27 (\$83.70)	28 (\$86.80)	29 (\$89.90)	30 (\$93.00)
31 (\$96.10)	32 (\$99.20)	33 (\$102.30)	34 (\$105.40)	35 (\$108.50)

We accept MasterCard and Visa for payment of orders. If you wish to use your credit card to pay for your ad fill in the following additional information (Sorry, no telephone orders can be accepted):

Card Number _____ Expiration Date _____

Please Print Name _____

Signature _____

IF YOU USE A BOX NUMBER YOU MUST INCLUDE YOUR PERMANENT ADDRESS AND PHONE NUMBER FOR OUR FILES. ADS SUBMITTED WITHOUT THIS INFORMATION WILL NOT BE ACCEPTED.

CLASSIFIED COMMERCIAL RATE: (for firms or individuals offering commercial products or services) \$3.10 per word prepaid (no charge for zip code)...**MINIMUM 15 WORDS.** 5% discount for same ad in 6 issues; 10% discount for same ad in 12 issues within one year; if prepaid (not applicable on credit card orders). **NON-COMMERCIAL RATE:** (for individuals who want to buy or sell a personal item) \$2.50 per word, prepaid...no minimum. **ONLY FIRST WORD AND NAME** set in bold caps at no extra charge. Additional bold face (not available as all caps) 55¢ per word additional. Entire ad in boldface, \$3.70 per word. **TINT SCREEN BEHIND ENTIRE AD: \$3.85 per word. TINT SCREEN BEHIND ENTIRE AD PLUS ALL BOLD FACE AD: \$4.50 per word. EXPANDED TYPE AD: \$4.70 per word prepaid.** Entire ad in boldface, \$5.60 per word. **TINT SCREEN BEHIND ENTIRE EXPANDED TYPE AD: \$5.90 per word. TINT SCREEN BEHIND ENTIRE EXPANDED TYPE AD PLUS ALL BOLD FACE AD: \$6.80 per word. DISPLAY ADS:** 1" x 2 1/8"—\$410.00; 2" x 2 1/8"—\$820.00; 3" x 2 1/4"—\$1230.00. **General Information:** Frequency rates and prepayment discounts are available. **ALL COPY SUBJECT TO PUBLISHERS APPROVAL. ADVERTISEMENTS USING P.O. BOX ADDRESS WILL NOT BE ACCEPTED UNTIL ADVERTISER SUPPLIES PUBLISHER WITH PERMANENT ADDRESS AND PHONE NUMBER.** Copy to be in our hands on the 1st of the third month preceding the date of the issue. (i.e., Aug. issue copy must be received by May 1st). When normal closing date falls on Saturday, Sunday or Holiday, issue closes on preceding working day. Send for the classified brochure. Circle Number 49 on the Free Information Card.

Quality Microwave TV Antennas

WIRELESS CABLE - IFTS - MMDS - Amateur TV
Ultra High Gain 50db(+) • Tuneable 1.9 to 2.7 Ghz

- 55-Channel Dish System \$199.95
- 36-Channel Dish System \$149.95
- 20-Channel Dish System \$124.95
- Optional Commercial Grid Antenna (not shown) Add \$50.00
- Yagi Antennas, Components, Custom Tuning Available
- Call or write (SASE) for "FREE" Catalog

PHILLIPS-TECH ELECTRONICS
P.O. Box 8533 • Scottsdale, AZ 85252
(602) 947-7700 (\$3.00 Credit all phone orders)

LIFETIME WARRANTY
MasterCard • Visa • American Express • COD's • Quantity Pricing

CABLE test chips. Jerrold, Tocom, S.A., Zenith. **Put cable boxes into full service mode!** \$29.95 to \$59.95. 1 (800) 452-7090, (310) 867-0081.

TOCOM-Jerrold Impulse-Scientific Atlanta Converters, two year warranties, also **test modules** for your converters. Contact **NATIONAL CABLE**, (219) 935-4128 full details.

SECRET cable descramblers! Build your own descrambler for **less than \$12.00** in seven **easy** steps. Complete instructions \$10.00. Radio Shack parts list and **free** descrambling methods that cost nothing to try included. **HARRYWHITE**, PO Box 1790, Baytown, TX 77520.

CB RADIO OWNERS!

We specialize in a wide variety of technical information, parts and services for CB radios. 10-Meter and FM conversion kits, repair books, plans, high-performance accessories. Thousands of satisfied customers since 1976! Catalog \$2

CBC INTERNATIONAL
P.O. BOX 31500RE, PHOENIX, AZ 85046

TEST equipment pre-owned now at affordable prices. Signal generators from \$50.00, oscilloscopes from \$50.00. Other equipment including manuals available. Send \$2.00 U.S. for catalog refunded on first order. **J.B. ELECTRONICS**, 3446 Dempster, Skokie, IL 60076. (708) 982-1973.

CABLE TV converters: Jerrold, Oak, Scientific Atlantic, Zenith & many others. "New MTS" stereo add-on: mute & volume. Ideal for 400 and 450 owners! 1 (800) 826-7623, Amex, Visa, M/C accepted. **B & B INC.**, 4030 Beau-D-Rue Drive, Eagan, MN 55122.

CABLE Converters, accessories below wholesale! Immediate delivery from giant stock! COD orders only. 1 (800) 995-1749.

EPROMS, Assorted, i.e., 27128A-15 \$3.00 each minimum quantity 13 pieces. C.O.D., American Express. **H.E.A.R.T. Inc.**, 1 (800) 677-3773.

WIRELESS CABLE RECEIVERS 1.9 to 2.7 GHz

36 CH 20" Parabolic Dish Sys. \$173.90
 36 CH 28" Rod Ant. Sys. \$193.90
 36 CH 16x20" Grid Ant. Sys. (photo) \$289.00
 36 CH 24x36" Grid Ant. Sys. \$314.95



SUN MICROWAVE INT'L. INC. Send \$1.00 for product catalog.
 PO BOX 34522 PHOENIX, AZ 85067 Dealer discounts available.
 (602) 230-1245 FAX (602) 269-6069
ORDERS ONLY 1-800-484-4190 code 9793

TEST-Aids for testing units in full service mode. Starcom VII, \$40.00; Starcom VI, \$30.00; Starcom DPBB, \$50.00; Pioneer clears error codes E2-E5, \$60.00; Pioneer cubes, will not alter internal serial #. \$125.00; Tocom VIP 5503-5507, \$25.00; Tocom mapping, \$40.00; S.A. 8500, \$25.00; 8550 \$30.00; 8580, \$40.00; 8570-90, \$50.00; Zenith, \$25.00; security bits and remotes. **N.E. ENGINEERING**, (617) 770-3830.

BASIC programmers, source code. Free catalog, **DIGITEK DATA**, 1350 Birchcrest Blvd., Port Charlotte, FL 33952. (813) 629-9313.

FREE CATALOG

FAMOUS "FIRESTIK" BRAND CB ANTENNAS AND ACCESSORIES. QUALITY PRODUCTS FOR THE SERIOUS CB'er. SINCE 1962
FIRESTIK ANTENNA COMPANY
 2614 EAST ADAMS
 PHOENIX, ARIZONA 85034

"SPEAKUP." Voice recorder board. Assembled, with mike and speaker, 8 seconds speech. Push-button record/play. Inputs for external rec/play/pause/stop. With schema. Experiment, build novelty toys, games. \$21.95 + \$2.00 S&H. Check or MO to **ELECTROGADGETS INC.**, PO Box 2065, Morris Township, NJ 07962.

PLATED thru hole PCB's prototype quantities. Two board minimum, fast, economical. For complete information call **AP CIRCUITS LTD.**, (403) 250-3406. BBS (403) 291-9342 (8,N,1).

CALLER ID — Displays caller's phone number \$39.95 ppd. Surveillance catalog \$5.00. **EDE**, POB 337, Buffalo, NY 14226.

CABLE TV converters. Jerrold, Zenith, Pioneer, Oak, Scientific Atlanta, and many more. 12 years experience gives us the advantage. Visa/MC Amex **COD ADVANTAGE ELECTRONICS, INC.**, 1 (800) 952-3916 1125 Riverwood Dr., Burnsville, MN 55337.

PAY TV AND SATELLITE DESCRAMBLING

ALL NEW 1992 EDITION ALL NEW
 1992 Edition updates latest Circuits. Turn-ons. Bypasses. Bullets. Bags. Black ciphers. VCI Plus and 8-Mac Fixes. Only \$15.95. **WIZARD HACKER'S BIBLE** includes Plus. **TRIP AL**, \$15.95. Pay TV and Satellite Descrambling Vol. 1 (Basics), 1989. 1991 Editions are all different. \$14.95 each. **MDS Handbook** \$9.95. Satellite Systems under \$600 \$12.95 (52). Any 3/\$29.95 or 5/\$49.95. Scrambling News Monthly will keep you up to date on Plus breaks. \$24.95/yr. special Everything we have including video. \$109.95 New Catalog \$1

Scrambling News, 1552 Hertel Ave., Buffalo, NY 14216. Voice/Fax (716) 874-2088
 COD'S ARE OK. ADD \$6

PREVENT descrambler damage. Don't bite the bullet! Snooper Stopper Data Pulse Blocker \$33.95, with Surge Protection \$44.95. Wireless Video Sender \$54.95. **VCI**, 1 (800) 925-9426.

300 Experimenters Circuits — Complete in 6 practical books using diodes, relays, FET's, LED's, IC 555's, and IC CA3130's for building blocks. Only \$33.00 plus \$5.50 for shipping. USA and Canada only. US funds. **ETT, INC.**, PO Box 240, Massapequa Park, NY 11762-0240.

USED "Sweet Art" computer cake decorating machine. Can reproduce photos using edible food color on cakes. Widow must sacrifice. Make offer. (619) 944-7244.

PLANS AND KITS

FASCINATING electronic devices! Dazers! Lasers! Transmitters! Detectors! Free energy! Tesla! Kits/assembled! Catalog \$4.00 (refundable). **QUANTUM RESEARCH**, 17919-77 Ave., Edmonton, AB. T5T 2S1.

HOBBY/broadcasting/HAM/CB/surveillance transmitters, amplifiers, cable TV, science, bugs, other great projects! Catalog \$1.00. **PANAXIS**, Box 130-F1, Paradise, CA 95967.

DESCRAMBLER kits. Complete cable kit \$44.95. Complete satellite kit \$49.95. Add \$5.00 shipping. Free brochure. No New York sales. **SUMMIT RE**, Box 489. Bronx, NY 10465.

REMOTE CONTROL KEYCHAIN

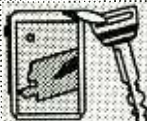

Complete w/mini-transmitter and 45Vdc RF receiver. Fully assembled including plans to build your own auto alarm. Check Visa or MC. \$24.95. Add \$3 shipping. 5 @ \$19.95, 10 @ \$14.95

Visitect Inc. Box 14156, Fremont, Ca. 94539
 (510) 651-1425 Fax (510) 651-8454

BUGGED? Phonetapped? Free catalog counter-surveillance equipment tells you fast! 1 (800) 732-5000.

SURVEILLANCE transmitter kits tune from 65 to 305 MHz. Mains powered duplex, telephone, room, combination telephone/room. Catalog with **Popular Communications**, **Popular Electronics** and **Radio-Electronics** book reviews of "Electronic Eavesdropping Equipment Design," \$2.00. **SHEFFIELD ELECTRONICS**, PO Box 377785-C, Chicago, IL 60637-7785.

PLANS and kits of high-tech electronic devices. Free catalog. **LNS TECHNOLOGIES**, 20993 Foothill Blvd., Suite 307R, Hayward, CA 94541-1511.

REMOVE LEAD VOCALS

From Records & CD's

Build this kit which removes lead vocals from standard stereo records, CD's, tapes or FM broadcasts. Sing along with the background music. Use with any home component stereo. Additional kit adds reverb to your voice, then mixes it with music. **Pre-assembled** boards also available. Write for free info. **Weeder Technologies, P.O. Box 421, Batavia, Ohio 45103.**

60 SOLDERLESS Breadboard Projects in two easy-to-read pocket books. Complete with circuit descriptions, schematics, parts layouts, component listings, etc. Both books (BP107 & BP113) only \$11.90 plus \$3.50 for shipping. USA and Canada only. US funds. **ETT, INC.**, PO Box 240, Massapequa Park, NY 11762-0240.

VIDEOCIPHER II / surveillance / satellite / scanner / cable / amateur / cellular. Catalog — \$3.00. **TELECODE**, PO Box 6426-RE, Yuma, AZ 85366-6426.

CREDIT card encoding revealed, encoding info \$5.00, w/plans & software (PC) \$12.25, w/kit \$64.50 + \$4.50 S/H (USA). Assembled add \$10.00. **BSC**, Box 1841, Alexandria, VA 22314.

SATELLITE tester, complete plans include parts list with suppliers \$10.00. Box 893, Crestwood, KY 40014.



GREAT Project. Silent Sam reminds you when you forget. SSTS (Turn Signal Reminder) beeps 3 seconds after 15 seconds. Cycle repeats until cancelled. Unobtrusive, recycles when braking. Compact kit mounts auto flasher. Parts, case, PCB, schematic, instructions \$15 PPD; 2/\$25; 3/\$30. Visa/MC. Free brochure 1-800-398-5605. **Prewired \$20 PPD; 2/\$35; 3/\$45** Silent Sam, 1627 Basil Dr., Columbus, OH 43227.

DESCRAMBLING, new secret manual. Build your own descramblers for **cable** and **subscription TV**. Instructions, schematics for SSAVI, gated sync, Sinewave, (HBO, Cinemax, Showtime, UHF, Adult) \$12.95, \$2.00 postage. **CABLETRONICS**, Box 30502R, Bethesda, MD 20824.

UNIVERSAL garage door remotes, phone scramblers, Tesla coils, free catalog. **INNOVATIVE ELECTRONICS**, (805) 487-9765. Please call.

CREDIT card R/W for PC design \$49.00. Any design info. \$5.00 **CPU ADVANCE**, Box 1089, Waltham, MA 02154.

PLANS: High tech high quality! Digital delay \$9.95, 24CH mixer \$14.95 stereo crossover, \$7.95, much more! **GEBHARDT**, Box 754, Anaconda, MT 59711.

BEST BY MAIL

Rates: Write National, Box 5, Sarasota, FL 34230

OF INTEREST TO ALL

BURGLAR ALARMS! WHOLESALERS. Send \$5.00 For Amazing Catalogue. Global Security, 672 Oldmill Road, Sult 320, DPT(A), Millersville, MD 21108.

50% OFF — TRAVEL & HOTELS! Send \$1.00. Traveler 372 Florin Rd., #223A, Sacramento, CA 95831.

MUSICAL INSTRUMENTS

TELL EVERY MUSICIAN You Know We're Looking For Unknown Amateurs For Possible Recording Contract. Ca Jack. 1-800-926-9559. Free Call. Recorded Message. Day Night. No Obligation.

CREDIT CARDS

CHRISTMAS SHOPPING SPECIAL: Guaranteed Visa or MasterCard to everybody. Free information: Noble Work Wide, PO Box 5179-RE, Santa Monica, CA 90409.

SATELLITE TV

FREE catalog — Lowest prices worldwide. **SKYVISION**, 1012 Frontier, Fergus Falls, MN 56537. 1 (800) 334-6455. See full page ad the Shopper section.

SATELLITE TV — Do it yourself — major brands discounted, we'll beat everyone's price. **DISCOUNT LARRY** (609) 596-0656.

VIDEOCIPHER II descrambling manual. Schematics, video, and audio. Explains DES, Eprom, CloneMaster, 3Musketeer, Pay-per-view (HBO, Cinemax, Showtime, Adult, etc.) \$16.95, \$2.00 postage. Schematics for Videocypher Plus, \$20.00. Schematics for Videocypher 032, \$15.00. Collection of software to copy and alter Eprom codes, \$25.00. **CABLETRONICS**, Box 30502R, Bethesda, MD 20824.

SUPER low satellite prices. Free U.S. and International catalog. **SATMAN**, (309) 692-4140 (Int'l), 1 (800) 472-8626 in U.S.

BE A GOOD NEIGHBOR

Volunteer.

 American Heart Association



Plug a Friend into **Electronics NOW**[®] and Save \$17.43!

This Christmas give an electrifying gift ... plug a friend into Electronics Now and brighten the whole new year! Whether electronics is your friend's livelihood or hobby, your gift will illuminate the whole spectrum of electronics throughout the coming year and provide a monthly reminder of your friendship.

Electronics Now will keep your friend informed and up-to-date with new ideas and innovations in all areas of electronics technology ... computers, video, radio, stereo, solid state devices, satellite TV, industrial and medical electronics, communications, robotics, and much, much more.

We'll provide great plans and printed circuit patterns for great electronic projects. In just the last year, Electronics Now has presented amateur TV equipment, computer peripherals, stereo transmitters, test equipment, speakerphones, robots, audio amplifiers, power inverters, and much more.

In coming issues, Electronics Now will present practical, educational, and money-saving projects like: an electronic drum, an audio effects generator, communications equipment, a light-beam communicator, a remote car starter, an uninterruptible power supply, and many others!

PLUS ... equipment troubleshooting techniques ... circuit design ... reports on new technology and new products ... equipment test reports ... in-depth coverage on computers, video, audio, shortwave radio ... and lots more exciting features and articles.

*Basic sub rate — 1 yr/\$19.97 2 yrs/\$38.97

SAVE \$17.43* ... OR EVEN \$35.83* ... For each gift of Electronics Now you give this Christmas, you save a full \$17.43* off the newsstand price. And as a gift donor, you're entitled to start or extend your own subscription at the same Special Holiday Gift Rate — you save an additional \$17.43*!

No need to send money ... if you prefer, we'll hold the bill till January, 1993. But you must rush the attached Gift Certificate to us to allow time to process your order and send a handsome gift announcement card, signed with your name, in time for Christmas.

So do it now ... take just a moment to fill in the names of a friend or two and mail the Gift Certificate to us in its attached, postage-paid reply envelope. That's all it takes to plug your friends into a whole year of exciting projects and new ideas in Electronics Now!

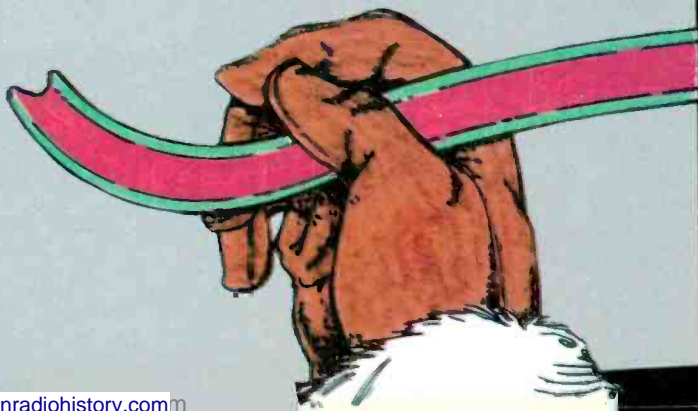

- 222 Popular Electronics (1992 back issues) **\$5.00**
Write in issues desired _____
- 221 Popular Electronics (1991 back issues, Jan., Mar. not available) **\$5.00**
Write in issues desired _____
- 220 Popular Electronics (1990 back issues) **\$5.00**
Write in issues desired _____
- 119 Popular Electronics (1989 back issues) **\$5.00**
Write in issues desired _____
- 118 Hands-On Electronics (1988 back issues) **\$5.00**
Write in issues desired _____
- 117 Hands-On Electronics (1987 back issues) **\$5.00**
Write in issues desired _____
- EH92 Experimenters Handbook (1992) **\$5.00**
- EH91 Experimenters Handbook (1991) **\$5.00**
- EH90 Experimenters Handbook (1990) **\$5.00**
- EH88 Experimenters Handbook (1988-89) **\$5.00**
- EH87 Experimenters Handbook (1987) **\$5.00**
- HH92 Hobbyist Handbook (1992) **\$5.00**
- HH91 Hobbyist Handbook (1991) **\$5.00**
- HH90 Hobbyist Handbook (1990) **\$5.00**
- HH89 Hobbyist Handbook (1989) **\$5.00**
- 212 Radio-Electronics (1992 back issues) **\$5.00**
- 211 Radio-Electronics (1991 back issues) **\$5.00**
Write in issues desired _____
- 210 Radio-Electronics (1990 back issues) **\$5.00**
Write in issues desired _____
- 109 Radio-Electronics (1989 back issues) **\$5.00**
Write in issues desired _____
- 108 Radio-Electronics (1988 back issues) **\$5.00**

- Write in issues desired _____
- 107 Radio-Electronics (1987 back issues) **\$5.00**
Write in issues desired _____

REPRINTS REPRINTS

- 169 Think Tank (133 Circuits) **\$3.50**
- 169A Think Tank Vol. 2 **\$3.00**
- 168 Fact Cards (#34-66) **\$4.00**
- 168C Fact Cards (#67-99) **\$3.50**
- 168D Fact Cards (#100-132) **\$3.50**
- 167 Designing With IC's **\$4.00**
- 166 Collected Works of Mohammed Ullyses Fips (62 pages, April Fools Collection) **\$5.00**
- 165 How to Repair CD Disc Players **\$5.00**
- 164 Modern Electrics (April 1908) **\$3.00**
- 163 Receiving Satellite TV **\$5.00**
- 162 Build Your Own Satellite TV Receiver **\$5.00**
- 161 Descrambling (Feb. 1984) **\$4.00**
- 160 New Ideas - 42 Circuits **\$3.50**
- 159 Low Frequency Receiving Techniques Building and using VLF Antennas **\$5.00**
- 158 Electro Importing Co. Catalog (Circa 1918) **\$5.95**
- 157 All About Kits **\$2.00**
- 156 How To Make PC Boards **\$2.00**
- 155 IBM Typewriter To Computer **\$2.00**
- 154 How To Repair VCR's **\$3.50**
- 150 Pay TV Decoder (1981) **\$3.00**

To order any of the items indicated above, check off the ones you want. Complete the order form below, **include your payment**, check or money order (DO NOT SEND CASH), and mail to **Claggg Inc.**, Reprint Department, P.O. Box 4099, Farmingdale, NY 11735. Please allow 4-6 weeks for delivery.

If you need a copy of an article that is in an issue we indicate is unavailable you can order it directly from us. We charge 50¢ per page. Indicate the issue (month & year), pages and article desired. Include payment in full, plus shipping and handling charge. Make checks payable to Claggg Inc.

ARTICLE

PAGES

MONTH

YEAR

TOTAL PAGES

@50¢ each

TOTAL PRICE

MAIL TO: **Claggg Inc.**

Reprint Bookstore, P.O. Box 4099, Farmingdale NY 11735

SHIPPING CHARGES IN USA & CANADA

\$0.01 to \$5.00	\$1.50	\$30.01 to 40.00	\$5.50
\$5.01 to \$10.00	\$2.50	\$40.01 to 50.00	\$6.50
\$10.01 to 20.00	\$3.50	\$50.01 and above	\$8.00
\$20.01 to 30.00	\$4.50		

Total price of merchandise	\$ _____
Shipping Charge (see chart)	\$ _____
Subtotal	\$ _____
Sales Tax (New York State Residents only)	\$ _____

Name _____

Total Enclosed **\$** _____

Address _____

City _____ State _____ Zip _____

All payments must be in U.S. funds

SORRY — We only ship to USA & Canada

EN193

Cable TV DESCRAMBLERS

**30-day
Money Back
Guarantee**



- The Most Complete Line of Descramblers
- Friendly, professional service
- **FREE Catalog**

**ORDER
NOW!**

1-800-228-7404

Go to the Source
NU-TEK ELECTRONICS
3250 Hatch RD
Cedar Park TEXAS 78613

BUSINESS OPPORTUNITIES

YOUR own radio station! Licensed/unlicensed AM, FM, TV, cable. Information \$1.00. **BROADCASTING**, Box 130-F1, Paradise, CA 95967.

LET the government finance your small business. Grants/loans to \$500,000. Free recorded message: (707) 449-8600. (KS1).

EASY work! Excellent pay! Assemble products at home. Call toll free 1 (800) 467-5566 Ext. 5192.

HOME assembly work available! Guaranteed easy money! Free details! **HOMEWORK-R**, Box 520, Danville, NH 03819.

MAKE \$75,000.00 to \$250,000.00 yearly or more fixing IBM color monitors. No investment, start doing it from your home (a telephone required). Information, USA, Canada \$2.00 cash for brochure, other countries \$10.00 US funds. **RANDALL DISPLAY**, Box 2168-R, Van Nuys, CA 91404 USA. FAX (818) 990-7803.

CABLE TV DESCRAMBLER LIQUIDATION!

FREE CATALOG!
Hamlin Combos \$44, Oak M35B \$60 (mln. 5), etc.
WEST COAST ELECTRONICS
For Information: 818-709-1758
Catalogs & Orders: 800-628-9656

CABLE TV DESCRAMBLERS ★ CONVERTERS ★ and ACCESSORIES.

SAVE MONEY. DON'T RENT!

PANASONIC, JERROLD, OAK,
PIONEER, SCIENTIFIC ATLANTA
AND MORE. LOWEST PRICES. FREE CATALOG.

**CABLE READY
COMPANY (800) 234-1006**

LEARN COMPUTERS!

Home study: become an expert with the personal computer for home or business use. Free literature: call 800-223-4542.

Name _____
 Address _____
 City _____ State _____ Zip _____
 School of Computer Training, Dept. KA342
 2245 Perimeter Pk., Atlanta, Georgia 30341

EDUCATION & INSTRUCTION

F.C.C. Commercial General Radiotelephone license. Electronics home study. Fast, inexpensive! "Free" details. **COMMAND**, D-176, Box 2824, San Francisco, CA 94126.

ELECTRONIC engineering, 8 volumes complete. \$109.95. No prior knowledge required. Free brochure. **BANNER TECHNICAL BOOKS**, 1203 Grant Avenue, Rockford, IL 61103.

VCR repair secrets, popular brands send \$7.50 check/MO. **ESA ELECTRONICS**, PO Box 541, Belle Chase, LA 70037.

"**PERMANENT Magnet Materials Short Course**." Complete history, materials listing, glossary, specifications, applications, design criteria, sources. Details \$2.50, order refundable. **SJL PUBLISHING**, Dept. A004EN, Hanna, IN 46340-0152.

COLLEGE degrees without classrooms. Complete information on hundreds of accredited schools. Free recorded message: (707) 447-3053. (6KS1)

CABLE BOX WHOLESALE, INC.

BEST BOXES—BEST PRICES

Immediate Shipping—COD's

Satisfaction Guaranteed

FREE Catalog—Call Now

800-841-7835

WANTED

INVENTORS: We submit ideas to industry. Find out what we can do for you. 1 (800) 288-IDEA.

INVENTORS

INVENTORS! Can you patent and profit from your idea? Call **AMERICAN INVENTORS CORP.** for free information. Serving inventors since 1975. 1 (800) 338-5656.

MASTERCARD AND VISA are now accepted for payment of your advertising. Simply complete the form on the first page of the Market Center and we will bill.

WHY RENT? \$AVE! \$AVE!

CABLE TV DESCRAMBLERS

**JERROLD • OAK • HAMLIN • ZENITH
PIONEER • SCIENTIFIC ATLANTA
READY-TO-SHIP!**

**6 MONTH WARRANTY! ABSOLUTELY
LOWEST WHOLESALE/RETAIL PRICES!**

MASTERCARD • VISA • AMEX • C.O.D.

**FREE COLOR CATALOG!
1 (800) 950-9145**



1470 OLD COUNTRY ROAD
SUITE 315 PE
PLAINVIEW, NY 11803
NO NY SALES

WE STOCK DESCRAMBLERS FOR ALL:

QUANTITY:	1	10	20
TOCOM 5503 & 5507 VIP Combination Unit	\$279	225	199
PIONEER 6000 SERIES Add-On Replacement Unit	189	165	150
JERROLD DPN7212 Add-On Replacement Unit	139	119	99
SCIENTIFIC ATLANTA 8580 Combination Unit	199	170	155

We carry lots of different equipment at great prices. Limited quantities on certain units. Call 800-253-0099. **ELECTECH**



RECEIVING TUBES

OVER 3000 TYPES IN STOCK!

Also hard-to-find transformers, capacitors and parts for tube equipment. Send \$2.00 for our 32 page catalog.

ANTIQUE ELECTRONIC SUPPLY
6221 S. Maple Ave. • Tempe, AZ 85283 • 602-820-5411

ANTIQUE RADIO CLASSIFIED

Free Sample!

Antique Radio's
Largest Circulation Monthly.
Articles, Ads & Classifieds.

6-Month Trial: \$15. 1-Yr: \$27 (\$40-1st Class).
A.R.C., P.O. Box 802-L9, Carlisle, MA 01741

THIS IS AN EXPANDED TYPE AD. Notice how it stands out on this page. To get your ad set in this type style mark your classified ad order, "Expanded-type ad," and calculate your cost at \$4.70 per word.

CABLE TV DESCRAMBLERS

*** VIDEO STABILIZERS AVAILABLE & Bullet Protectors ***

MULTI-VISION ELECTRONICS 2730 SO 123RD CT STE #126 OMAHA, NE 68114

1-800-835-2330

BEST BUYS BEST SERVICE

1-800-327-8544

STARTS WITH A FREE CATALOG

TECH LINE (402) 331-3228



BY PURCHASING CABLE EQUIPMENT FROM MULTIVISION ELECTRONICS THE PURCHASER AGREES TO COMPLY WITH STATE & FEDERAL LAWS REGARDING PRIVATE OWNERSHIP OF CABLE TV EQUIPMENT. IF YOU ARE UNSURE OF THE SE LAWS CHECK WITH YOUR LOCAL OFFICIALS.

(FEATURING))

1. Call Identifiers
2. Power Antennas
3. Mind-Machines
4. Wireless Cable Receivers T.V. 1.9-2.7 GHz
5. Stun-Guns
6. Surveillance
7. Dual Deck VCR

Courteous Service • Discount Prices • Fast Shipping

ALL ELECTRONICS CORP.

Mail Order Electronic Parts And Supplies
P.O. Box 567 • Van Nuys, CA 91408

LASER POWER SUPPLY

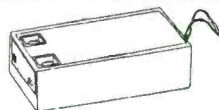

Epoxy encapsulated power supply for up to 2 mW lasers. 4 1/2" X 1 1/2" X 1 7/16".
 Input: 9 Vdc @ 1 amp. Output starting voltage: 7 to 8 kV. Operating voltage: 1.1 to 1.5 kV
 Operating current: 4 to 5 mA. Recessed 0.250 quick connect terminals for output.
 Color coded wire leads for input.
CAT # LPS-1 \$35.00 each

RECHARGEABLE Gell Cell Batteries

Maintenance free, rechargeable batteries. Ideal for portable power or back-up power for communications, video, alarms etc. Useable in any position.

6 VOLTS @ 1.2 AMP/HOURS

Size: 3.81" X
1" X 2" high.
CAT# GC-612
\$6.50 each

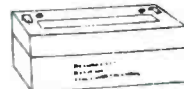

12 VOLTS @ 10 AMP/HOURS

Two 6 volt 10 A/H
batteries, assembled
as a single 12 volt
package. Package
size: 6" X 3.94" X 3.75"
CAT# GC-1210 \$35.00 each

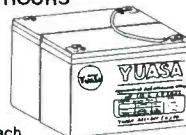

RADIOSONDE WEATHER INFORMATION TRANSMITTER

Viz(r) Radiosonde

A "radiosonde" is a weather instrument, usually released at high altitudes, designed to transmit temperature, humidity, winds and pressure at various heights above the ground. These are new units, discontinued from NOAA national weather service. Contains lots of interesting parts: a solid state transmitter, barometric pressure sensor, humidity sensor and a 24 volt battery which is activated when submersed in water. Great for school science demonstrations or as a source for parts.

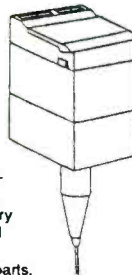

CAT# WIT-1 \$4.75 each • Case of 16 for \$64.00

4 AAA RECHARGEABLE BATTERY PACK (USED)

Battery pack with 4 AAA nickel-cadmium batteries in series to make a 4.8 volt pack. Batteries can be separated and reconfigured if desired. Terminated by 4 pin female connector (0.1" centers) on 4" leads.

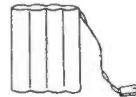

CAT# NCB-43U \$3.00 per pack

TOLL FREE ORDER LINES

1-800-826-5432

CHARGE ORDERS in Visa, MasterCard or Discover

TERMS: Minimum order \$10.00. Shipping and handling for the 48 continental U.S.A. \$3.50 per order. All others including AK, HI, PR or Canada must pay full shipping. All orders delivered in CALIFORNIA must include state sales tax (7.25%, 7.5%, 7.75%, 8.25% 8.5%). Quantities Limited. NO C.O.D. Prices subject to change w/out notice.

Call or Write For Our
FREE 64 Page Catalog
(Outside The U.S.A. Send \$2.00 Postage)
ALL ELECTRONICS CORP.
P.O. Box 567 • Van Nuys, CA • 91408

VCR Cross Reference

NOW Find the right Part
for your VCR



with the
**IS CET VCR
CROSS REFERENCE**

This 272-page reference contains both model and part-number cross-references and now includes the FREE 56-page 1991 updates.

VCR's are made in a few factories from which hundreds of different brand names and model numbers identify cosmetically-changed identical and near-identical manufactured units. Interchangeable parts are very common. An exact replacement part may be available only a few minutes away from you even though the manufacturer supplier is out-of-stock. You may be able to cannibalize scrap units at no cost!

The IS CET VCR Cross Reference and 1991 Update pages are pre-punched for standard loose-leaf binding...\$38.00 plus \$3.00 for shipping for each reference.

Electronics Technology Today Inc.
VCR CROSS REFERENCE OFFER
P.O. Box 240,
Farmingdale, New York 11735

Name _____

Business _____

Address _____

City _____

State _____ Zip _____

Phone _____

Enclose \$38.00 for the IS CET VCR Cross Reference and 1991 Update Reference and \$3.00 for shipping for each reference.

I have ordered _____ IS CET VCR Cross Reference(s).
The total amount of my order is \$ _____.

Check enclosed—do not send cash.
or please charge my credit card:

Visa MasterCard Exp. Date ____/____/____

Card No. _____

Signature _____

New York State residents must add applicable local sales tax to total.



NEW!
NO-CODE
**HAM
LICENSES ARE
HERE!**

All About Ham Radio by Harry Helms, AA6FW, tells how to get your *codefree* ham license and talk to the world. In over 300 pages, you'll learn about:

- packet (computer-to-computer) radio
- ham television
- using ham radio satellites
- contacting stations in foreign countries

and many other exciting topics explained in a friendly, humorous style without a lot of math and or technical jargon. If you've been wanting a ham license, this is the book you've been waiting for!

Only \$19.95 at bookstores and radio equipment dealers. Or order direct from HighText! Add \$3 shipping (\$4 to Canada, \$5 elsewhere). CA please add sales tax. U.S. funds only please.

HighText
publications Inc.

7128 Miramar Rd., Suite 15L
San Diego, CA 92121

DO YOU OFTEN WISH THAT THE SMITH COMPANY WAS THE SMITH & SMITH & SMITH & SMITH COMPANY?

Business people often find themselves doing so many things that just one of them isn't enough. So hire some of the needy and disadvantaged young people of America this summer to help you. Hiring them can also help you in another very important way. Because a business that hires economically disadvantaged youth during the summer may get as much as an 85% tax credit on the first \$3,000 of wages you pay them. Write the National Alliance of Business at P.O. Box 7207, Washington D.C. 20044. And support your local summer-jobs-for-youth programs. You'll be doing something for yourself, for your business, for your community, and for the needy youth of America, too.

LET'S GET ALL OF AMERICA WORKING AGAIN.

Ad A PUBLIC SERVICE
OF THIS PUBLICATION &
COUNCIL THE ADVERTISING COUNCIL

Form **1040** U.S. Department
For the year ending

Label

Use IRS label
Otherwise,
please print
or type

L A B E L H E R E	Your first name
	If a job
	Home
City	

Presidential
Election Campaign

Filing Status

1
2
3
4
5

Check only one box

Exemptions

DON'T LET THIS COME BETWEEN YOU AND YOUR PEACE OF MIND.

Your taxes will be that much less taxing if you get them off your list of things to do and do them now. So file now and file accurately. And make your taxes less taxing. **MAKE YOUR TAXES LESS TAXING.**

A Public Service of This Publication & **Ad Council** Internal Revenue Service

• 800 • 831 • 4242

ur Resource for Value. Only a Phone Call Away.

ENTER YOUR KIT, AND WIN!

Send us your original electronics kit concept. If selected, we'll offer it in our catalog and you'll win \$300.

We reserve all rights for approval of entries.

Call Jameco for complete contest details at 1-800-831-8020.



REGULATED POWER SUPPLY KITS

Build the power supply you've been needing for years. Ideal for home or instructional use, select from three different versions. Each kit is complete with printed circuit board, electronic components, and user assembly instructions.

513 No.	Product No.	Input Voltage (VAC)	Output Voltage (VDC)	Current (mA)	Dimensions (L x W x H inches)	Price
1360	JE200	120	+5	1000	3.5 x 5.0 x 2.0	14.95
1626	JE215	120	+5 to +15 -5 to -15	750 to 175 750 to 175	3.5 x 5.0 x 2.0	19.95
1613	JE225	120	+5 fixed +3 to +12 -3 to -12	1000 100 100	5.12 x 5.12 x 2.25	29.95

VOICE SCRAMBLER KIT

Transmit voice messages with complete privacy and security. The Voice Scrambler Kit converts intelligible human speech into unrecognizable garble for recording or transmitting over standard media. The descrambler mode restores the signal to fully intelligible speech. Operate with a cassette tape recorder or build a secure telephone system using a separate kit at each end of the line.

Audio Power Output: 0.5 Watts

Resolution: 8 bits (companded, Mu-Law)

Sample Rate: 8 kHz

Power Supply: +5 & -5 VDC @ 25 mA,
+12 VDC @ 250 mA;
(recommend power supply 1R73613- left)

Dimensions: PCB is 3.55" x 3.10" (LxW)

Part No.	Price
1R70519	\$34.95

TWO-DIGIT VOLTMETER KIT

Now you can build a versatile, practical, high-performance digital panel voltmeter. Finished kits deliver ±2% accuracy at full scale. Its basic input range of 0.0 to 9.9 VDC is easily scaled for any application.

Input Impedance: 82K ohm with 9.9 VDC range

Displays: 0.3" red MAN74A type

Power Supply: +5 VDC, regulated, 100 mA;
(recommend power supply 1R20360- left)

Dimensions: 4.3" x 2.2" x 1.3" (LxWxH)

Part No.	Price
1R70527	\$24.95

EPROMS

No.	Product No.	Price
611	TMS2716	\$5.95
909	2708	4.95
002	2716	3.95
125	2732A-25	3.49
230	2764A-20	3.75
429	27C64-15	3.95
853	27C64-45	2.95
933	27128-25	7.75
968	27128A-20	4.75
984	27128A-25	3.75
677	27C128-15	5.75
037	27256-15	5.49
061	27256-25	4.89
714	27C256-15	5.95
722	27C256-20	5.49
150	27512-20	6.75
781	27C512-15	6.95
699	27C020-15	17.95
692	68766-35	4.95

Linear IC's*

No.	Product No.	Price
1241	TL082CP	\$5.99
1579	LM317T	.59
1683	LM324N	.35
1771	LM336Z	1.09
1851	LM339N	.45
7422	NE555V	.29
1328	LM556N	.49
1467	LM723CN	.49
1539	LM741CN	.29
3131	LM1458N	.39
3157	LM1488N	.45
3181	LM1489N	.45
4278	ULN2003A	.69
4230	LM3914N	2.49
7385	NE5532	1.19
1262	7805T	.45
1334	7812T	.45

* Name brand IC's in stock

IC Sockets

Part No.	Product No.	Description	Price
1R51570	8LP	8-pin low profile	\$.10
1R37161	14LP	14-pin low profile	.11
1R37372	16LP	16-pin low profile	.12
1R39335	24LP	24-pin low profile	.19
1R40301	28LP	28-pin low profile	.22
1R41110	40LP	40-pin low profile	.28

Connectors

Part No.	Product No.	Description	Price
1R15114	DB25P	Male, 25-pin	\$.65
1R15157	DB25S	Female, 25-pin	.75
1R15085	DB25H	Hood	.39
1R15106	DB25MH	Metal Hood	1.35

Transistors And Diodes

Part No.	Product No.	Description	Price
1R28628	PN2222	TO-92 case	\$.12
1R28644	PN2907	TO-92 case	.12
1R35991	1N4004	DO-41 case	.10
1R38236	2N2222A	TO-18 case	.25
1R36126	1N4735	DO-41 case	.25
1R38359	2N3904	TO-92 case	.12
1R36290	1N751	DO-35 case	.15
1R38421	2N4401	TO-92 case	.15
1R36038	1N4148	DO-35 case	.07
1R38308	2N3055	TO-3 case	.69

Switches

Part No.	Product No.	Description	Price
1R21936	JMT123	SPDT, on-on (toggle)	\$.15
1R38842	206-8	SPST, 16-pin (DIP)	1.09
1R26622	MS102	SPST, momentary (push-button)	.39

*Additional components available

Memory

Part No.	Product No.	Function	Price
1R41398	41256-120	256K DIP	120ns...\$1.69
1R42251	511000P-80	1MB DIP	80ns.....5.99
1R41523	41256A9B-80	256K SIMM	80ns.....16.95
1R41718	421000A9A-80	1MB SIPP	80ns.....54.95
1R41769	421000A9B-80	1MB SIMM	80ns.....54.95

LEDs

Part No.	Product No.	Description	Price
1R34761	XC556G	T1 3/4, (green)	\$.16
1R34796	XC556R	T1 3/4, (red)	.12
1R34825	XC556Y	T1 3/4, (yellow)	.16

Order toll-free
1-800-831-4242



Call or write for your
1993 Annual Catalog:
1-800-637-8471

JAMECO™
ELECTRONIC COMPONENTS
COMPUTER PRODUCTS

1355 Shoreway Road
Belmont, CA 94002
FAX: 1-800-237-6948 (Domestic)
FAX: 415-592-2503 (International)

\$30.00 Minimum Order

For International Sales, Customer Service, Credit Department and all other inquiries: Call 415-592-8097 between 7AM-5PM P.S.T.

CA Residents please add applicable sales tax.

Terms: Prices subject to change without notice. Items subject to availability and prior sale. Complete list of terms/warranties is available upon request.

© 1993 Jameco 193 All trademarks are registered trademarks of their respective companies.



Cable TV Descrambler Kits

Universal Kit..... \$59.95
Includes all parts and PC Board. Not included is the ac adaptor or enclosure.

Tri-Mode Kit.....\$39.00
Includes all parts, PC Board and AC Adaptor. Not included is the enclosure.

SB-3 Kit.....\$29.00
Includes all parts, PC Board and AC Adaptor. Not included is the enclosure.

Universal Tutorial.....\$9.95
Includes an in depth study of the technology used and has troubleshooting hints.

Tri-Mode Tutorial.....\$9.95
Includes a gate by gate study of the circuit and has troubleshooting hints.

Snooper Stopper.....\$39.00
Protect yourself from descrambler detection and stop the "bullet".

**Call Toll Free
1-800-258-1134
C.O.D.**

**M & G Electronics, Inc.
301 Westminister Street
Providence, RI. 02903**

CIRCLE 186 ON FREE INFORMATION CARD

ADVERTISING INDEX

Electronics Now does not assume any responsibility for errors that may appear in the index below.

Free Information Number	Page
108	AMC Sales 73
107	All Electronics 95
77, 185	B&K Precision 9
—	CIE 15
54	Chemtronics 3
178	Chenesko Products 27
—	CLAGGK Video Offer CV3
—	Command Productions 73
58	Cook's Institute 75
127	Deco Industries 27
—	ETT/ISCET 96
176	Electronic Goldmine 98
—	Electronic Tech. Today 17
—	Electronics Book Club 76
—	Electronics Engineers B.C. 7
121	Fluke Manufacturing CV2
—	Grantham College 54
183	HAMEG Instruments 21
—	HighText Publications, Inc. 96
—	ISCET 81
114	Jameco 97
186	M&G Electronics 98
89	MAT Electronics 28
—	Mini Circuits CV4
117	Mouser 81
—	NRI Schools 22
182	Northeast Electronics 75
179	People's College 19
78	Radio Shack 30
—	Star Circuits 27
92	Tektronix 10
123	Test Probes 27
177	The School Of VCR Repair ... 9, 95
181	U.S. Cable 71
184	Viejo Publications 85
180	Zentek Corp. 71

ADVERTISING SALES OFFICE

Gernsback Publications, Inc.
500-B Bi-County Blvd.
Farmingdale, NY 11735
1-(516) 293-3000
President: Larry Steckler

For Advertising ONLY
516-293-3000
Fax 1-516-293-3115

Larry Steckler
publisher
Christina Estrada
assistant to the President
Arline Fishman
advertising director
Denise Mullen
advertising assistant
Kelly McQuade
credit manager

Subscriber Customer Service
1-800-288-0652

Order Entry for New Subscribers
1-800-999-7139
7:00 AM - 6:00 PM M-F MST

ADVERTISING SALES OFFICES

EAST/SOUTHEAST
Stanley Levitan, Eastern Advertising
Sales Manager
Electronics Now
1 Overlook Ave.
Great Neck, NY 11021
1-516-487-9357, 1-516-293-3000
Fax 1-516-487-8402

MIDWEST/Texas/Arkansas/Okla.
Ralph Bergen, Midwest Advertising
Sales Manager
Electronics Now
One Northfield Plaza, Suite 300
Northfield, IL 60093-1214
1-708-446-1444
Fax 1-708-559-0562

PACIFIC COAST/Mountain States
Electronics Now Magazine
Pamela Kuster
Pattis/3M
1800 North Highland Avenue
Suite 717
Hollywood, CA 90028
1-213-462-2700
FAX 1-213-463-0544

EN Shopper
Joe Shere, National Representative
P.O. Box 169
Idyllwild, CA 92549
1-714-659-9743
Fax 1-714-659-2469

THE ELECTRONIC GOLDMINE



The Electronic Goldmine has one of the greatest selections of unique electronic kits available in the world! We have over 65 kits and over 1900 unique bargain priced components in our new 80 page catalog!

ROAMR ROBOT KIT

Here's one of the most exciting robot kits available to the Hobbyist today! Our new ROAMR Robot explores by itself and happily produces robot sounds and robot lights as it detects and avoids obstacles. ROAMR has a metal chassis for solid construction, 4 LED lights,

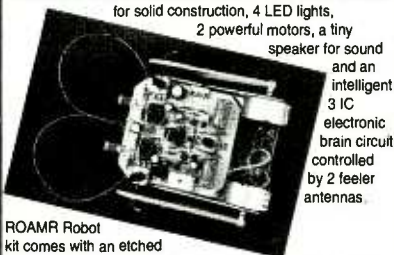

2 powerful motors, a tiny speaker for sound and an intelligent 3 IC electronic brain circuit controlled by 2 feeler antennas.

ROAMR Robot kit comes with an etched and drilled circuit board, all electronic components, a metal chassis with motors mounted, all hardware and instructions. Requires 4 AA batteries (not included). Size about 5" square Skill level 3.

As Seen In
Radio Electronics
June 1992

Reg. \$39.95
Sale Priced
\$34.95

Offer expires January 31, 1993



MINIMUM ORDER: \$10.00 Plus \$3.50 shipping and handling \$6.99 for U.S. Mail. We accept MC, VISA, and Money Orders.
SEND ORDERS TO: THE ELECTRONIC GOLDMINE
P.O. BOX 5408 FARMINGDALE, AZ 85261
PHONE ORDERS (602) 451-7454 FAX ORDERS (602) 451-9495

CIRCLE 176 ON FREE INFORMATION CARD

Countersurveillance

Never before has so much professional information on the art of detecting and eliminating electronic snooping devices—and how to defend against experienced information thieves—been placed in one VHS video. If you are a Fortune 500 CEO, an executive in any hi-tech industry, or a novice seeking entry into an honorable, rewarding field of work in countersurveillance, you must view this video presentation again and again.



CALL NOW!

1-516-293-3751

HAVE YOUR VISA or MC CARD AVAILABLE

Wake up! You may be the victim of stolen words—precious ideas that would have made you very wealthy! Yes, professionals, even rank amateurs, may be listening to your most private conversations.

Wake up! If you are not the victim, then you are surrounded by countless victims who need your help if you know how to discover telephone taps, locate bugs, or “sweep” a room clean.

There is a thriving professional service steeped in high-tech techniques that you can become a part of! But first, you must know and understand Countersurveillance Technology. Your very first insight into this highly rewarding field is made possible by a video VHS presentation that you cannot view on broadcast television, satellite, or cable. It presents an informative program prepared by professionals in the field who know their industry, its techniques, kinks and loopholes. Men who can tell you more in 45 minutes in a straightforward, exclusive talk than was ever attempted before.

Foiling Information Thieves

Discover the targets professional snoopers seek out! The prey are stock brokers, arbitrage firms, manufacturers, high-tech companies, any competitive industry, or even small businesses in the same community. The valuable information they filch may be marketing strategies, customer lists, product formulas, manufacturing techniques, even advertising plans. Information thieves eavesdrop on court decisions, bidding information, financial data. The list is unlimited in the mind of man—especially if he is a thief!

You know that the Russians secretly installed countless microphones on the concrete work of the American Embassy building in Moscow. They converted

what was to be an embassy and private residence into the most sophisticated recording studio the world had ever known. The building had to be torn down in order to remove all the bugs.

Stolen Information

The open taps from where the information pours out may be from FAX's, computer communications, telephone calls, and everyday business meetings and lunchtime encounters. Businessmen need counselling on how to eliminate this information drain. Basic telephone use coupled with the user's understanding that someone may be listening or recording vital data and information greatly reduces the opportunity for others to purloin meaningful information.

The professional discussions seen on the TV screen in your home reveals how to detect and disable wiretaps, midget radio-frequency transmitters, and other bugs, plus when to use disinformation to confuse the unwanted listener, and the technique of voice scrambling telephone communications. In fact, do you know how to look for a bug, where to look for a bug, and what to do when you find it?

Bugs of a very small size are easy to build and they can be placed quickly in a matter of seconds, in any object or room. Today you may have used a telephone handset that was bugged. It probably contained three bugs. One was a phony bug to fool you into believing you found a bug and secured the telephone. The second bug placates the investigator when he finds the real thing! And the third bug is found only by the professional, who continued to search just in case there were more bugs.

The professional is not without his tools. Special equipment has been designed so that the professional can sweep a room so that he can detect voice-activated (VOX) and remote-activated bugs. Some of this equipment can be operated by novices, others require a trained countersurveillance professional.

The professionals viewed on your television screen reveal information on the latest technological advances like laser-beam snoopers that are installed hundreds of feet away from the room they snoop on. The professionals disclose that computers yield information too easily.

This advertisement was not written by a countersurveillance professional, but by a beginner whose only experience came from viewing the video tape in the privacy of his home. After you review the video carefully and understand its contents, you have taken the first important step in either acquiring professional help with your surveillance problems, or you may very well consider a career as a countersurveillance professional.

The Dollars You Save

To obtain the information contained in the video VHS cassette, you would attend a professional seminar costing \$350-750 and possibly pay hundreds of dollars more if you had to travel to a distant city to attend. Now, for only \$49.95 (plus \$4.00 P&H) you can view *Countersurveillance Techniques* at home and take refresher views often. To obtain your copy, complete the coupon or call.

CLAGGK INC. EN
P.O. Box 4099 • Farmingdale, NY 11735

Please rush my copy of the Countersurveillance Techniques Video VHS Cassette for a total cost of \$53.95 each (which includes \$4.00 postage and handling).

No. of Cassettes ordered _____
Amount of payment \$ _____
Sales tax (N.Y.S. only) _____
Total enclosed _____
Bill me VISA MasterCard
Card No. _____
Expire Date _____ / _____
Signature _____
Name _____
Address _____
City _____ State _____ ZIP _____

All payments in U.S.A. funds. Canadians add \$4.00 per VHS cassette. No foreign orders.

DC-2000 MHz AMPLIFIERS

In plastic and ceramic packages, for low-cost solutions to dozens of application requirements, select Mini-Circuits' flatpack or surface-mount wideband monolithic amplifiers. For example, cascade three MAR-2 monolithic amplifiers and end up with a 25dB gain, 0.3 to 2000MHz amplifier for less than \$4.50. Design values and circuit board layout available on request.

It's just as easy to create an amplifier that meets other specific needs, whether it be low noise, high gain, or medium power. Select from Mini-Circuits' wide assortment of models (see Chart), sketch a simple interconnect layout, and the design is done. Each model is characterized with S parameter data included in our 740-page RF/IF Designers' Handbook.

All Mini-Circuits' amplifiers feature tight unit-to-unit repeatability, high reliability, a one-year guarantee, tape and reel packaging, off-the-shelf availability, with prices starting at 99 cents.

Mini-Circuits' monolithic amplifiers...for innovative do-it-yourself problem solvers.



Models above shown actual size

from **99¢**

Unit price \$ (1-25 qty)

for plastic surface-mount add suffix SM (example MAR-1SM)

			++VAM-3 1.45	+VAM-6 1.29	++VAM-7 1.75			
PLASTIC SURFACE-MOUNT	MAR-1	MAR-2	MAR-3	MAR-4	MAR-6	MAR-7	MAR-8	
	1.04	1.40	1.50	1.60	1.34	1.80	1.75	
	MAV-1	+MAV-2	+MAV-3	MAV-4				
	1.15	1.45	1.55	1.65			MAV-11 2.15	
CERAMIC SURFACE-MOUNT	RAM-1	RAM-2	RAM-3	RAM-4	RAM-6	RAM-7	RAM-8	
	4.95	4.95	4.95	4.95	4.95	4.95	4.95	
	MAV-1	+MAV-2	+MAV-3	MAV-4				
	1.10	1.40	1.50	1.60			MAV-11 2.10	
PLASTIC FLAT-PACK	MAR-1	MAR-2	MAR-3	MAR-4	MAR-6	MAR-7	MAR-8	
	0.99	1.35	1.45	1.55	1.29	1.75	1.70	
	Freq. MHz, DC to	1000	2000	2000	1000	2000	2000	1000
	Gain, dB at 100MHz	18.5	12.5	12.5	8.3	20	13.5	32.5
Output Pwr. +dBm	1.5	4.5	10.0	12.5	2.0	5.5	12.5	17.5
NF, dB	5.5	6.5	6.0	6.5	3.0	5.0	3.3	3.6

Notes: + Frequency range DC-1500MHz ++ Gain 1/2 dB less than shown

designer's kit, KH-1 available only \$59.95 includes:
40 AMPLIFIERS* 10 MAR-1, 10 MAR-3, 10 MAR-4, 10 MAR-8
150 CAPACITORS* 50 100 pf, 50 1,000 pf, 50 10,000 pf

740 page RF/IF DESIGNER'S HANDBOOK

* MIXERS • POWER SPLITTER/COMBINERS • AMPLIFIERS • ELECTRONIC ATTENUATORS
• I&Q/PSK MODULATORS • ATTENUATORS/TERMINATIONS • DIRECTIONAL COUPLERS
• RF TRANSFORMERS • DIGITAL ATTENUATORS • PHASE DETECTORS • SWITCHES/DRIVERS
• FILTERS • LIMITERS • FREQUENCY DOUBLERS

*values or models may be substituted without notice, depending on supplies.

Typical Circuit Arrangement

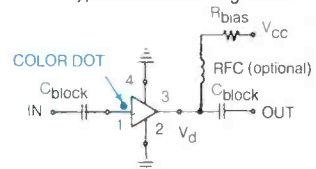

finding new ways ...
setting higher standards

Mini-Circuits™

WE ACCEPT AMERICAN EXPRESS AND VISA

P.O. Box 350166, Brooklyn, New York 11235-0003 (718) 934-4500 Fax (718) 332-4661

Distribution Centers / NORTH AMERICA 800-654-7949 • 417-335-5935 Fax 417-335-5945 EUROPE 44-252-835094 Fax 44-252-837010

CIRCLE 192 ON FREE INFORMATION CARD

www.americanradiohistory.com